



**WELZH
WERKZEUG**
PRODUCT CATALOGUE
2019



THE APEX OF INNOVATION

WELZH WERKZEUG



WELZH WERKZEUG

FOUNDED IN 2011

The idea behind Welzh Werkzeug has always been to produce high quality new and innovative tools at highly competitive prices and we still do so today.

This year we've continued to grow by moving our team in to a new head office, perfectly situated near our existing storage and local manufacturing sites as well as massively expanding our storage capacity with the addition of our new 20,000ft³ warehouse.

The upgrades have allowed us to serve our customers better than ever, add more innovative new products and increase availability across the entire range.



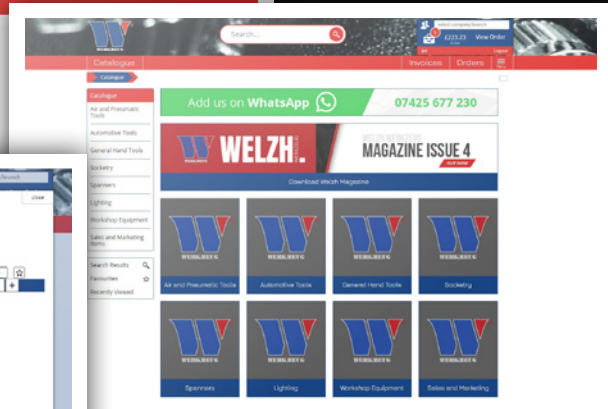
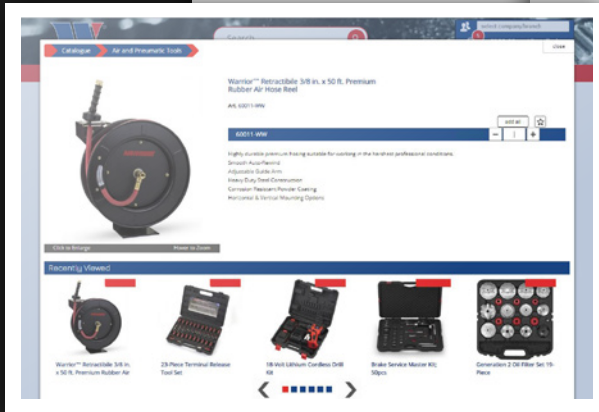
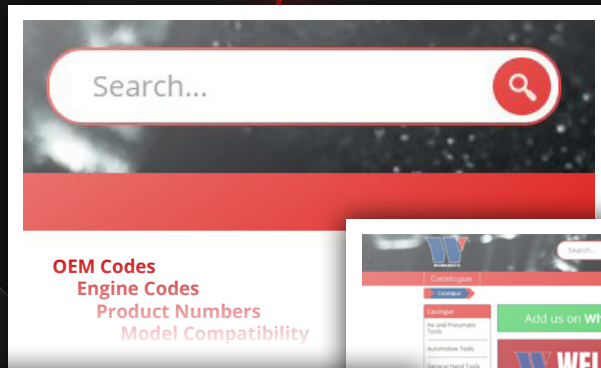

ORDER ONLINE

B2B WEBSITE

Approved dealers can gain access to our B2B web store, ensuring they are always up to date on the latest products and promotions.

Search OEM codes, engine codes and product numbers to find exactly what you need for any job.

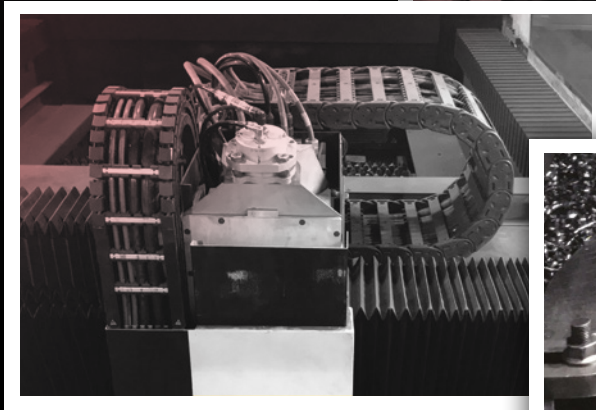
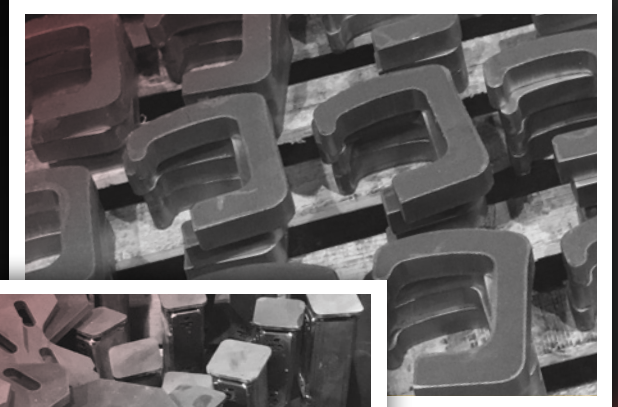

MADE IN BRITAIN

LOCAL MANUFACTURING

Local manufacturing allows us to rapidly prototype and extensively test new products before bringing them to market.

This ensures our customers get the best quality equipment and the latest innovations at a competitive price.

OUR BRANDS

TARGETED INNOVATION

Our innovative product range is designed to maximise your productivity and earning potential by making light work of awkward and time consuming tasks. Our R&D team continues to focus on specialist automotive tasks with the highest potential efficiency improvements, ensuring our customers can minimise their work time and maximise their earning potential.



WELZH WERKZEUG

PROFESSIONAL AUTOMOTIVE PRODUCTS

Innovative professional quality tools for the automotive sector.



UNITED TOOL CORPORATION

CONSUMER LEVEL TOOLS

A diverse range of consumer level products for workshop and DIY use.



WERK CONNECT

CONSUMABLES

Consumable parts and accessories for professional or DIY use.



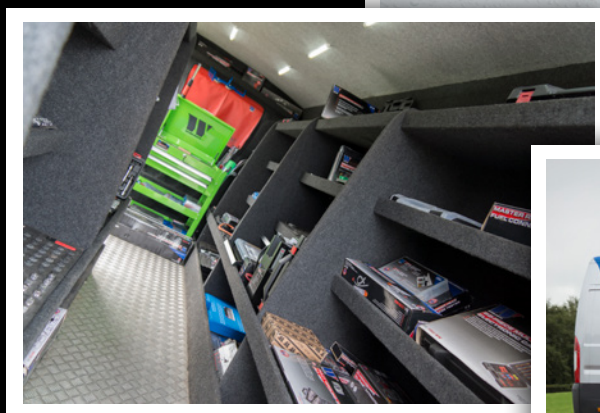

DEMO VAN SESSIONS

DIRECT TO YOU

Our mobile demo vans are available for showcasing a wide range of the latest and most popular tools and able to demonstrate specific products on request.

Dealers call today and book a demo session to see how our innovative product range can help you expand your business.

AIR & POWER TOOLS



Warrior™ Air Line Hose; 3/8" x 10m

Air Lines > Air Hose

Highly durable premium hosing suitable for working in harsh professional conditions.
 High Strength Braided Polyester Reinforcement.
 Extreme Abrasion & Ozone Resistant Cover.
 Grease, Oil & Diesel Resistant.
 Anti-Kink Hosing Lies Flat.
 Oil Resistant Core Tubing.
 Fire retardant Rating CO1 25% Oxygen.
 Service Temperature 15°C to + 60°C.
 Bore: 3/8".
 Length: 10m.



Art. 60008-WW

Warrior™ 1/2" x 50 ft. Premium Rubber Air Hose

Air Lines > Air Hose

Highly durable premium hosing suitable for working in harsh professional conditions.
 High Strength Braided Polyester Reinforcement.
 Extreme Abrasion & Ozone Resistant Cover.
 Grease, Oil & Diesel Resistant.
 Anti-Kink Hosing Lies Flat.
 Oil Resistant Core Tubing.
 Fire retardant Rating CO1 25% Oxygen.
 Service Temperature 15°C to + 60°C.
 Bore: 1/2".
 Length: 15m.



Art. 60010-WW

Warrior™ 3/8" x 50 ft. Premium Rubber Air Hose

Air Lines > Air Line Reels

Highly durable premium hosing suitable for working in harsh professional conditions.
 High Strength Braided Polyester Reinforcement.
 Extreme Abrasion & Ozone Resistant Cover.
 Grease, Oil & Diesel Resistant.
 Anti-Kink Hosing Lies Flat.
 Oil Resistant Core Tubing.
 Fire retardant Rating CO1 25% Oxygen.
 Service Temperature 15°C to + 60°C.
 Bore: 3/8".
 Length: 15m.



Art. 60032-WW

Warrior™ Air Line Swivel Attachment; 3/8"

Air Lines > Air Line Accessories

Made from the same high quality material as the Warrior™ air lines.
 Working pressure: 20 bar.
 Fitted with ergonomic grip for added control-ability in the working environment.
 Swivel air fixing allow ease of use in the workshop reducing the possibility of getting tangled.
 Bore: 3/8".



Art. 60006-WW

Air Line Reel Adjustable Wall Fixing

Air Tool Accessories > Air Line Accessories

Reel attachment allow the unit to be adjusted to give more flexibility.
 Usable with full range of Warrior reel products:
 60009-ww.
 60011-ww.
 60012-ww



Art. 60005-WW

Warrior™ Air Hose Reel; Retractable, 3/8" x 10m

Air Lines > Air Line Reels

Highly durable premium hosing suitable for working in harsh professional conditions.
 High Strength Braided Polyester Reinforcement.
 Extreme Abrasion & Ozone Resistant Cover.
 Grease, Oil & Diesel Resistant.
 Anti-Kink Hosing Lies Flat.
 Oil Resistant Core Tubing.
 Horizontal & Vertical Mounting Options.
 Corrosion Resistant Powder Coating.
 Heavy Duty Steel Construction.
 Smooth Auto-Rewind.
 Adjustable Guide Arm.
 Fire retardant Rating CO1 25% Oxygen.
 Service Temperature 15°C to + 60°C.
 Bore: 3/8".
 Length: 10m, On retractable reel.

Art. 60009-WW



Warrior™ Retractable 3/8" x 50 ft. Premium Rubber Air Hose Reel

Air Lines > Air Line Reels

Highly durable premium hosing suitable for working in harsh professional conditions.
 High Strength Braided Polyester Reinforcement.
 Extreme Abrasion & Ozone Resistant Cover.
 Grease, Oil & Diesel Resistant.
 Anti-Kink Hosing Lies Flat.
 Oil Resistant Core Tubing.
 Horizontal & Vertical Mounting Options.
 Corrosion Resistant Powder Coating.
 Heavy Duty Steel Construction.
 Smooth Auto-Rewind.
 Adjustable Guide Arm.
 Fire retardant Rating CO1 25% Oxygen.
 Service Temperature 15°C to + 60°C.
 Bore: 3/8".
 Length: 15m, On retractable reel.

Art. 60011-WW



Warrior™ 1/2" x 50 ft. Premium Rubber Air Hose Reel

Air Lines > Air Line Reel

Highly durable premium hosing suitable for working in harsh professional conditions.
 High Strength Braided Polyester Reinforcement.
 Extreme Abrasion & Ozone Resistant Cover.
 Grease, Oil & Diesel Resistant.
 Anti-Kink Hosing Lies Flat.
 Oil Resistant Core Tubing.
 Horizontal & Vertical Mounting Options.
 Corrosion Resistant Powder Coating.
 Heavy Duty Steel Construction.
 Smooth Auto-Rewind.
 Adjustable Guide Arm.
 Fire retardant Rating CO1 25% Oxygen.
 Service Temperature 15°C to + 60°C.
 Bore: 1/2".
 Length: 15m, On retractable reel.

Art. 60012-WW



Welzh 3/8" x 50 ft. Rubber Air Hose & Reel

Air Lines > Air Line Reels

360° Swivel fitting reduces hose kinking & twisting.
 Suitable for wall, floor and ceiling mounting.
 Maximum working pressure: 300 PSI.
 Heavy duty steel construction.
 Easy to use manual crank.
 3/8" Air Inlet & Outlet.
 3/8" Hose Diameter.
 15m Hose Length.
 UK Air Fitting.

Art. 912-WW



Air Hose 10-Meters; Blue Bird

Air Lines > Air Line Hoses

Cold-weather flexibility, the durability and premium feel of high-end rubber hose & the light-weight of premium hybrid hoses.

Ozone resistant cover provides protection from extreme weather, abrasions & kinks.

Constructed with high strength polyester braided reinforcement lessons carbon footprint.

Flexibility in extreme conditions from -50 Degrees F to 180 Degrees F.

Features include: Ultra light and super-strong rubber.

4 finger grip bend restriction for better ergonomics.

Overall Length Options 10mm

Working Pressure 300 PSI.



Art. 4030-WW

Air Hose 20-Meters; Blue Bird

Air Lines > Air Line Hoses

Cold-weather flexibility, the durability and premium feel of high-end rubber hose & the light-weight of premium hybrid hoses.

Ozone resistant cover provides protection from extreme weather, abrasions & kinks.

Constructed with high strength polyester braided reinforcement lessons carbon footprint.

Flexibility in extreme conditions from -50 Degrees F to 180 Degrees F.

Features include: Ultra light and super-strong rubber.

4 finger grip bend restriction for better ergonomics.

Overall Length Options 20mm

Working Pressure 300 PSI.



Art. 4031-WW

Air Hose Reel 15M With Blue Bird Hose; Retractable

Air Lines > Air Line Reels

Cold-weather flexibility, the durability and premium feel of high-end rubber hose & the light-weight of premium hybrid hoses.

Ozone resistant cover provides protection from extreme weather, abrasions & kinks.

Constructed with high strength polyester braided reinforcement lessons carbon footprint.

Flexibility in extreme conditions from -50 Degrees F to 180 Degrees F.

Features include: Ultra light and super-strong rubber.

4 finger grip bend restriction for better ergonomics.

Overall Length Options 10 & 20mm Max.

Working Pressure 300 PSI.

Safety Factor 4:1.

15 m retractable.

Wall mountable.



Art. 4042-WW

Air Hose Reel 15 Meter Retractable

Air Lines > Air Line Reels

Suitable for mounting on wall, floor and ceiling.

With hose stop, auto retracting.

Air inlet: 1/4" quick coupling.

Air outlet: 1/4" quick coupling.

Maximum pressure air flow 708 l/min.

Made of steel sheet.

Hose made of PVC.

Max Pressure: 20 bar.



Art. 811-WW

Air Inlet Swivel Joint

Air Tool Accessories > Air Line Accessories

2 x 180 degree swing arc.
Useful accessory designed to make air lines less of a hindrance.
High visibility colour.



Art. 1226-WW

12-Piece Air Hose Connector Adaptor Set UK Fitting

Air Tool Accessories > Air Line Accessories

For use with air tools and air lines.
Included: 1/4" f & m coupler.
3/8" m coupler.
2 x 1/4" m & f plugs.
2 x 8 mm hose tail plugs.
3/8" f and m plugs.
10 mm hose tail plug.
Thread type: BSP taper.



Art. 557-WW

12-Piece Air Hose Connector Adaptor Set High Flow Fitting

Air Tool Accessories > Air Line Accessories

For use with air tools and air lines.
Included: 1/4" f & m coupler.
2 x 8 mm hose tail plugs.
10 mm hose tail plug.
2 x 1/4" m & f plugs.
3/8" f and m plugs.
Thread type: 1/4.
3/8" m coupler.



Art. 559-WW

Vibration Hammer Chisel Adaptors, 9-Piece

Air Tool Accessories > Air Tool Attachments

Length 220mm with 4 profiles: 1/2"D with Hex on shaft for use with impact tools.
Concave, Flat and Curved.
Manufactured from SCM440 steel.
Extra long for hard to reach areas.



Art. 1070-17-WW



Vibration Hammer Adaptor 1070-7

Air Tool Accessories > Air Tool Attachments

To be used with impact sockets.
Equivalent to 1/2".

Art. 1070-7-WW



Vibration Hammer Adaptor 1070-4

Air Tool Accessories > Air Tool Attachments

Designed to aid in the pressing of ball joints and other seized components.
Included with 1070-WW.

Art. 1070-4-WW



Vibration Hammer Adaptor 1070-5

Air Tool Accessories > Air Tool Attachments

Designed to act like a hammer.
Flat head.

Art. 1070-5-WW



Vibration Hammer Adaptor 1070-6

Air Tool Accessories > Air Tool Attachments

For use with pressing plate kits such as 1013-1-WW and 1198-WW.
Included with 1070-WW.

Art. 1070-6-WW



Vibration Hammer Adaptor 1070-3

Air Tool Accessories > Air Tool Attachments

Vibration adaptor for use with 1070-ww.



Art. 1070-3-WW

Vibration Hammer Tyre Puncture Adaptor

Air Tool Accessories > Air Tool Attachments

To be used with the 1070 vibration hammer for repairing punctures in tyres.



Art. 1070-9-WW

Replacement Chuck For 1070-WW

Air Tool Accessories > Air Tool Attachments

Replacement chuck for 1070-ww.



Art. 1070-CHUCK-WW

Pneumatic Bolt Remover G-VIBRO

Air Tool Accessories > Air Tool Attachments

Designed to be used with 1070-WW (1070-10-WW).
Allows loosening of rusted track rod nuts.
Improves the entering of rust remover spray.
C-frame prevents slipping of the nut.
Heavy duty construction.
10 mm shaft diameter.
Clear width: 25 mm.
Length: 190 mm.
Width: 65 mm.



Art. 1148-WW

Injector Removal Tool; Vibration Hammer Edition

Air Tool Accessories > Air Tool Attachments

This kit has been exclusively designed to remove stuck injectors via the use of a slide hammer or the 1070-WW Vibro gun. This can be found in Art. 1238-WW.



Art. 1238-1-WW

Vibration Hammer Exhaust Chisels 2-Piece

Air Tool Accessories > Air Tool Attachments

When used with the 1070-WW vibro hammer the job will take seconds. Designed to aid in the removal of exhausts with minimal effort.



Art. 1070-11-WW

Vibration Needle De-scaler Attachment

Air Tool Accessories > Air Tool Attachments

Oscillating effect of needles provides effective results for removal of rust and paint. Additional adaptor for use with 1070-WW Vibration Hammer.



Art. 1070-12-WW

Vibro Adaptor For Locking Wheel Nuts

Air Tool Accessories > Air Tool Attachments

To be used with 1158-WW and 4063-WW.
Comes with 1158-11-WW.



Art. 1070-13-WW

Pin Punches for Use with 1070-WW

Air Tool Accessories > Air Tool Attachments

Six different diameters for most common sizes:
 Prevention of the punch getting stuck with reduced shaft with a specialist role.
 Gives the extra driving force of an air hammer where needed.
 Can be used with our air hammer 1070-WW.
 Especially used to remove metal pins.
 Diameter: 5.2, 5.2, 6.9, 7.7, 9.3, 12.7 mm.



Art. 4080-WW

Vibration Impact Loosening Lever for Welzh 1070-WW

Air Tool Accessories > Air Tool Attachments

Designed loosening tightly fitted screws.
 Very useful when working on belt pulleys.
 100 mm lever with 1/2" square drive.
 Works with 1070-WW.
 560 mm impact shaft.



Art. 1070-14-WW

Wall Mount For 1070-WW

Air Tool Accessories > Air Tool Attachments

Designed to store the 1070-WW vibro hammer and adapters in a neat and easily accessible location.
 Perfect for any workshop or garage.
 Tools sold separately.



Art. 1070-15-WW

Vibration Hammer Adaptors Extra Long, 4-Piece

Air Tool Accessories > Air Tool Attachments

Length 220mm with 4 profiles: 1/2"D with Hex on shaft for use with impact tools, Concave, Flat and Curved.
 Extra long for hard to reach areas.
 Manufactured from SCM440 steel.



Art. 1070-16-WW

Socket Set for use with Air Hammer (Vibration Impact)

Specialist Sockets > Other Specialist Sockets

Designed to loosen and remove stuck, seized and rusted fixings (bolts, screws, etc.).
To be used with vibration hammers. Works with item 1070-WW.
Suitable for use with a wide range of fixings including bolts, screws, nuts, glow plugs & more.
The go-through flex head ratchet wrench allows for easy application of torque.
7-Piece 6pt Deep Impact Sockets includes: 8, 9, 10, 11, 12, 13, 14mm.



Art. 4093-WW

Injector Removal Tool Kit; Vibration Hammer Edition

Air Tool Accessories > Air Tool Attachments

Slide hammer provides efficient force to the removal adaptors.
A fast, damage-free solution for removing injectors.
Adaptors provided to suit a wide range of vehicles.



Art. 1238-WW

52-Piece Mounting Press Set

Air Tool Accessories > Air Tool Attachments

Suitable for mounting of bearings, sealing rings and rubbers.
Works well with WELZH 1070-WW.
This kit includes mounting pads in following sizes:
18 to 65 mm (1 mm steps) and 74 mm.
12 mm Ø bore.
180 mm metal handle for use with hammer.



Art. 1013-1-WW

Suspension Screw Extractor for VAG; 4-link Suspensions

Steering and Suspension > Universal Steering and Suspension

Special tool to remove the clamping screws on fourwishbone front axles.
Applications.
Audi, SEAT,Skoda, VW.
To be used with a air hammer.
10mm round shank.
Can be used with 1070-WW vibro gun.



Art. 1187-WW

Vibration Hammer

Air Tools > Air Hammer

Perfect for removing stuck parts such as bearings, bushings, suspension parts, ball joints and much more.

Blows per minute: 2100.

Quick release chuck.

Air supply: 6.2 bar.

Weight: 2.4 kg.



Art. 1070-10-WW

Vibration Hammer & 9-Piece Special Adaptor Set

Air Tools > Air Hammer

For the removal of stuck components and parts. Perfect for use on bearings, bushings, suspension parts, ball joints and much more.

The range of accessories for this item is growing constantly.

Specifications:

Weight: 2.4 kg.

Air supply: 6.2 bar.

Blows per minute: 2100.

Quick release chuck.

Applications:

Can be used with our locking wheel nut kits, bush press sets and many others.

The hammer is also sold separate under 1070-10-WW.

Storage bracket available separately.



Art. 1070-WW

Vibration Hammer & 14-Piece Special Adaptor Set

Air Tools > Air Hammer

2x Adapters for repairing punctures in tyres.

1x 1/2" Drive Impact Socket Adapter.

3x Circular Adapter: 38, 63, 74mm.

1x Ball joint pressing adapter.

1x Flat head hammer adapter.

1x Exhaust removal adapter.

1x Pressing Plate adapter.

Vibration Hammer.

2x Other adapters.

10x O-Rings.



Art. 60039-WW

Air Hammer Kit; Composite

Air Tools > Air Hammer

Suitable for work on car body and for mechanics.

Strokes per min. 3,500.

Air consumption 179 l/min.

Chisel shank: round, 10 mm.

Stroke: 67 mm.

Working pressure 6.2 bar.

Air connection: 1/4".

Includes:

4 chisel with different profiles.

Plastic coated air hammer.

Quick release head.



Art. 2123-WW

IMPACT WRENCHES

INDUSTRIAL QUALITY



Impact Wrench; Air, 1/2", 1982 nm (The Beast)

Handle exhaust directs air away from the work piece operator.
Energy efficient motor for maximum performance & long life.
The front housing & back head cover made from magnesium alloy.
Full Torque of 1982Nm reached in just 5 seconds.
Durability composite material.
High-speed: 9000rpm.
Lightweight: 1.65kg.

Air Tools > Air Impact Wrench



Art. 3000-WW

Impact Wrench; Air, 1/2", 1982 nm (The Beast) Green

Air Tools > Air Impact Wrench

Handle exhaust directs air away from the work piece operator.
 Energy efficient motor for maximum performance & long life.
 The front housing & back head cover made from magnesium alloy.
 Full Torque of 1982Nm reached in just 5 seconds.
 Durability composite material.
 High-speed: 9000rpm.
 Lightweight: 1.65kg.



Art. 3000-1-WW

Impact Wrench; 1/2", 680 nm, (Mini)

Air Tools > Air Impact Wrench

Air consumption: 198.1 L/min (7 cfm).
 Working pressure: 90psi (6.3 Bar).
 Noise level: lpa= 89.5 Db (a).
 Max. Torque: 680 nm.
 Lwa= 100.5 Db (a).
 Square drive: 1/2".
 Air inlet: 1/4".



Art. 1031-WW

Impact Wrench; Air, 1/2", 1600 nm

Air Tools > Air Impact Wrench

Convenient one-handed operation with quick reverse level at trigger for left or right handed user.
 TWIN-HAMMER mechanism provides more power and smooth balanced blows.
 Uphill soft grip provides comfortable holding even for long time operations.
 With a Maximum Torque of 1600nm.
 1/2" Square Drive.
 Speed: 7500rpm.
 Length: 174 mm.
 Weight: 1.8kg.
 Air Inlet: 1/4".



Art. 2114-WW

Impact Wrench; 3/4", 1860 nm

Air Tools > Air Impact Wrench

Rear mounted direction adjustment.
 The outer casing is made from steel.
 Twin hammer function.
 Max torque: 1860 nm.
 Air pressure: 8 kg.
 Drive: 3/4".



Art. 3117-WW

Impact Wrench with Anvil Head; 1", 2200 nm (Stubby Version)

Air Tools > Air Impact Wrench

Vibration: 7.029 m/s² (max) K= 1.5 m/s².
Min. hose inner diameter: 1/2".
LwA: 102 dB(A) KwA: 3 dB(A).
LpA: 91 dB(A) KpA: 3 dB(A).
Air consumption: 40 cfm.
Max. air pressure: 115 psi.
Max. torque: 2200 Nm.
Free speed: 3900 rpm.
Stubby Version.
Square drive: 1".
Air inlet: 1/2".



Art. 3116-1-WW

Impact Wrench with Anvil Head; 1", 2200 nm

Air Tools > Air Impact Wrench

Vibration: 7.029 m/s² (max) K= 1.5 m/s².
LwA: 102 dB(A) KwA: 3 dB(A).
LpA: 91 dB(A) KpA: 3 dB(A).
Air consumption: 40 cfm.
Max. air pressure: 115 psi.
Max. torque: 2200 Nm.
Free speed: 3900 rpm.
Stubby Version.
Square drive: 1".
Air inlet: 1/2".



Art. 3116-WW

Impact Wrench; Composite, 1/2", 1350 nm

Air Tools > Air Impact Wrench

Comes with Twin Hammer Function.
Power out put of 1360NM.
Air Pressure: 6.2 bar.
Air Inlet: (90psi)1/4".
1/2" Square Drive.
Speed: 6800rpm.
Length: 190mm.
Weight: 1.9kg.



Art. 3115-WW

Impact Wrench; Composite, 1/2", 1385 nm

Air Tools > Air Impact Wrench

Square Drive: 1/2".
Max.Torque(n-m/ft-lb): 1145/845.
AVG.Air Consumption 25%(scfm): 7.0.
Free Speed(rpm): 7000.
Clutch Type: Twin Hammers.
Exhaust: Handle.
Length(inch/mm): 7.56/192.
Weight(lbs/kgs): 4.75/2.16.
Air Pressure: 90psi/6.3kg/c.
Air Inlet(npt): 1/4".



Art. 3120-WW

Impact Wrench; Ultra Mini, 1/2", 800 nm (Red)

Air Tools > Air Impact Wrench

Perfect for compact working environments or everyday use.
Huge power of 800NM with a weight of only 1kg.
Steady and constant delivery of torque.
Ultra Compact Mini Impact wrench.
Dimensions: 110 x 160 mm.
3 stage power control.
1/2" square drive.



Art. 3114-WW

Impact Wrench; Ultra Mini, 1/2", 800 nm (Green)

Air Tools > Air Impact Wrench

Perfect for compact working environments or everyday use.
Huge power of 800NM with a weight of only 1kg.
Steady and constant delivery of torque.
Ultra Compact Mini Impact wrench.
Dimensions: 110 x 160 mm.
3 stage power control.
1/2" square drive.



Art. 3114-1-WW

Impact Wrench; Ultra Mini, 3/8", 800 nm (Red)

Air Tools > Air Impact Wrench

Perfect for compact working environments or everyday use.
Huge power of 800NM with a weight of only 1kg.
Steady and constant delivery of torque.
Ultra Compact Mini Impact wrench.
Dimensions: 110 x 160 mm.
3 stage power control.
3/8" square drive.



Art. 3118-WW

Protective Rubber Cover For 3114-WW

Air Tool Accessories > Air Tool Attachments

Protective Rubber Cover For 3114-WW & 3114-1-WW.



Art. 3114-2-WW

Air Ratchet; 3/8" Heavy Duty Composite Housing

Air Tools > Air Impact Wrench

Free Speed: 160 RPM.
Air Consumption: 4 CFM.
Max Torque: 80 ft-lb.
Air Inlet: 3/8".
Length: 256 mm.
Weight: 1.4 kg.
Hose Size: 1/2".
Sound: 90 db.



Art. 3018-WW

Air Ratchet; 1/2" Heavy Duty Composite Housing

Air Tools > Air Impact Wrench

Free Speed: 160 RPM.
Air Consumption: 4 CFM.
Max Torque: 80 ft-lb.
Air Inlet: 1/2".
Length: 256 mm.
Weight: 1.4 kg.
Hose Size: 1/2".
Sound: 90 db.



Art. 3019-WW

Air Ratchet; 3/8"

Air Tools > Air Ratchets

A versatile, reversible tool ideal for auto workshop use.
Average air consumption 4cfm.
Operating pressure 6.2bar.
Maximum speed 150rpm.
Max torque 50ft/lb.



Art. 3012-WW

Air Ratchet; 1/2"

Air Tools > Air Ratchets

A versatile, reversible tool ideal for auto workshop use.
Average air consumption 4cfm.
Operating pressure 6.2bar.
Maximum speed 150rpm.
Max torque 50ft/lb.



Art. 3013-WW

Air Ratchet; 1/4", Mini Type

Air Tools > Air Ratchets

1/4 inch drive mini air ratchet.
 Air Consumption: 1.8 cfm.
 Vibration: 4.31m/s.
 Speed: 350rpm.
 Length: 125mm.
 Hose Size: 3/8.
 Sound: 80dba.
 Air Inlet: 1/4".



Art. 1111-WW

Air Ratchet; 3/8", Mini Type

Air Tools > Air Ratchets

3/8 inch drive mini air ratchet.
 Air Consumption: 1.8 cfm.
 Vibration: 4.31m/s.
 Speed: 350rpm.
 Length: 125mm.
 Hose Size: 3/8.
 Sound: 80dba.
 Air Inlet: 1/4".



Art. 1112-WW

Air Installation Tool For CV Boots

Steering and Suspension > CV Joints

For the installation of CV boots without removing the drive shaft.
 Save huge amounts of time compared to traditional methods.
 Specification Value.
 Joint Diameter 110 mm.
 Weight 2kg.
 Max Air Pressure 116psi.
 Air Inlet 1/4" BSP.



Art. 4192-WW

Car Tyre Booster

Wheel and Tyres > Tyre Workshop

Tyre booster helps filling tires with loose beads as a result of e.g. prolonged storage.
 Max. pressure: 11 bar, limited by safety valve.
 Tank capacity: 20 l.
 Weight: ca. 13 kg.
 Dimensions (without filling cone):
 Ø 260 mm x width 420.



Art. 8001-WW

Air Ratchet; Impact Type, 3/8"

Air Tools > Air Ratchets

Working pressure: 6.3 bar.
Avg. Air Cons.: 88l/min.
Free speed: 700.
Hammer impact.
Torque 70 nm.
Length: 164.
Weight: 0.6.
3/8".



Art. 3119-WW

Drill with Keyless Chuck; Air Operated, 3/8"

Air Tools > Air Drills

Lightweight design with noise reduction technology.
Features one handed forward and reverse switch with a variable speed trigger.
Free speed: 1800 rpm.
Chuck capacity: 10 mm.
Spindle capacity: 3/8".
Length 184: mm.
Weight 1100: g.
Air consumption: 4 cfm.
Air inlet: 1/4".
Sound level: 83dB.



Art. 2115-WW

Drill With Key-less Chuck; Air Operated, 3/8", Angled

Air Tools > Air Drills

For use when drilling, grinding, polishing to normal and not hard to reach places.
Infinitely variable speed control by trigger from 0 - 1500 U /min.
Height of head type: manual include chuck: 97mm.
Speed, continuously adjustable: 0 - 1500 /min.
Chuck by 3 triple steel jaws 0,8 - 10mm.
Recommended hose diameter: 3/8".
Working pressure: 6,3 bar (90psi).
Noise declared value LWA: 95 dB.
Also for right-angle cutting of bars.
Forward / reverse quick switch.
Air consumption: 1 / min: 113.
Drilling in steel up to 10mm.
Length of unit: 210 mm.
10mm key-less chuck.
Weight: 1468 g.



Art. 3009-WW

Cut Off Tool Composite, Extra Long, 310 mm

Air Tools > Air Grinders

Lightweight aluminium housing.
2-component soft handle.
Steel guard protects you from sparks.
Lever block trigger for safety.
With rear exhaust.
Cutting disc size: Ø 75 mm.
Cutting disc bore: Ø 10 mm.
Working pressure 6.2 bar.
Air connection: 1/4".
Max. drive speed 18,000 rpm.



Art. 2119-WW

Die Grinder 6 mm Extra Long Shaft Composite 340mm

Air Tools > Air Grinders

Excellent for contour grinding, cutting, polishing, shaping, deflashing and keying.
Shaft length: 127 mm.
Capacity 1/4" (6 mm).
Extra long shaft.



Art. 2120-WW

Die Grinder 6 mm Composite 170mm

Air Tools > Air Grinders

Excellent for contour grinding, cutting, polishing, shaping, deflashing and keying.
Heavy and robust extended air die grinder for universal use.
Easy and handy to use.
Capacity 1/4" (6 mm).
Professional quality.



Art. 2122-WW

Die Grinder 90° Angle Composite

Air Tools > Air Grinders

Excellent for contour grinding, cutting, polishing, shaping, de-flashing and keying.
Total length: 155 mm.
Capacity 1/4" (6 mm).
90° Angled head.



Art. 2124-WW

Die Grinder; Mini Type (Ultra Short)

Air Tools > Air Grinders

Perfect for tight spaces.
Ultra compact design.
6mm collect size.
Safety lever.
Ideal for:
Contour Grinding.
Cutting.
Polishing.
Shaping.
De-flashing.
Keying.



Art. 3014-WW

Angle Grinder; Ultra Short

Air Tools > Air Grinders

Perfect for tight spaces.
Ultra compact design.
2ö(51mm) Capacity.
Safety Lever.
Ideal for body work.
Additional disks available separately:
4mm disks (3015-1-ww).
1mm disks (3015-2-ww).



Art. 3015-WW

Die Grinder; Ultra Short

Air Tools > Air Grinders

Perfect for tight spaces.
Ultra compact design.
6mm collect size.
Safety lever.
Ideal for:
Contour Grinding.
Cutting.
Polishing.
Shaping.
De-flashing.
Keying.



Art. 3016-WW

Die Grinder; Micro Type, Pneumatic

Air Tools > Air Grinders

Pneumatic Micro Die Grinder.
The cutting edge WELZH MICRO DIE GRINDER has been developed for use in restricted access areas for the automotive industry.
Incorporating balanced precision handling due to the light weight composite design.
Anti vibration and low sound level.
Precision Cutting, Milling, Grinding.
Tungsten Micro Burrs (10 Pcs).
Supplied In BMC.
Length: 135mm.
70,000rpm.
Additional burrs available: 3020-1-WW.



Art. 3020-WW

Needle Scaler Composite

Air Tools > Other Air Tools

Ideal for removing rust and paint.
Stroke speed: 4000 bpm.
Max. pressure: 6.2 bar.
Air consumption 198 l/min.
Air inlet: 1/4".
Included needles are consumable.
Additional needles available: 2121-1-ww.



Art. 2121-WW



Air Nibbler

[Air Tools > Other Air Tools](#)

Fingertip operated throttle for feathering control.
Equipped with quick connectors.
Cutting capacity:
1.4mm on Steel.
1.8mm on Aluminium.
Additional blades available: 3006-1-WW.



Art. 3006-WW

Metal Shear; Air Operated

[Air Tools > Other Air Tools](#)

The head design allows for contour cuts and straight cuts.
Precisely Cuts up 18 gauge sheet metal.
Precision Hardened gearing.
Increases life of air shear.
Ball bearing mounted motor.
Designed for smooth operation.
Aluminium Trigger.
Cutting capacity:
1.2mm Steel.
1.6mm Aluminium.
Speed:2600rpm.
Weight:1.37kg.
Additional blades available: 3007-1-WW.



Art. 3007-WW

Butterfly Gun; 3/8"

[Air Tools > Other Air Tools](#)

One hand forward and reverse.
Bolt capacity: 10mm.
Free speed: 11000rpm.
Max torque: 135mm.
Length: 160mm.
Weight: 0.9kg.



Art. 3008-WW

Mini BAT" Gun 3/8dr"

[Air Tools > Other Air Tools](#)

One hand forward and reverse.
Bolt capacity: 10mm.
Free speed: 11000rpm.
Max torque: 135mm.
Length: 160mm.
Weight: 0.9kg.



Art. 4136-WW

Pneumatic Rotary Removal Tool

Air Tools > Other Air Tools

The 180 degree adjustable handle allows you to get into anywhere. Variable speed control for any application. This tool comes with a variety of accessories that will help you perform a wide range of tasks. It comes in a blow moulded case, and contains the following accessories:

- 1 Eraser Wheel.
- 1 Cleaning Disc Wheel.
- 1 Fine Wire Wheel.
- 1 Medium Wire Wheel.
- 1 Course Wire Wheel.



Art. 7013-WW

Brake Caliper Rewind Spindle; Air Operated

Air Tools > Other Air Tools

Adapter plate fully retracts into backing plate, thus particularly suitable for small brake piston distance.

Suitable for all Welzh wind back kits found in the Automotive section.
Works well with Welzh Brake Pin Adaptors (4193-WW).



Art. 1054-WW

Sand Blaster; Air Operated, Hand Held, 1/4" NPT

Air Tools > Other Air Tools

Polymer body with alloy internals.
Operating pressure: 90 psi.
Air flow: 1.41 CFM at 100psi.
Nozzle size: 2-15/16" (length) x 7/32.
Air consumption: 7CFM.
Suitable for brown aluminium oxide sand.



Art. 2125-WW

Sander; Mini Type, 3", Air

Air Tools > Air Sanders

High performance and convenience in the palm of your hand.
Ideal for the removal of rust, surface deposits, and welds in hard-to-reach areas.
Ball bearing construction enhances durability and smooth power delivery.
Double-sided, adjustable speed settings provide variability for a broader range of applications.
3 inch spindle thread.
RPM: 1500.
Average CFM: 2.1.



Art. 3001-WW

Sander; Belt Type (10x330mm), Air Operated

Air Tools > Air Sanders

For grinding of small surfaces, cleaning of brake calipers when replacing the brake pads, etc.
Universally adjustable angle of incline.
Abrasive belt size: 330 x 10 mm.
Max. Speed: 20000 rpm.
Air consumption: 400 l/min.
Working pressure: 6.3 bar.
Air inlet: 1/4".
Weight: 1.2 kg.
Dimension: 310 x 85 x 50 mm.
Noise level: LpA: = 93 dB(A) / LwA: = 104 dg(A).
Vibration level: ahd = 4.8 m/s.



Art. 3004-WW

Reciprocating Saw, Low Vibration; Air Operated

Air Tools > Air Saws

Low vibration reduces fatigue.
Free speed: 10,000 SPM.
Max vibrations: 3 m/s².
Sound level: 80 dba.
Net weight: 1.2 lbs.
Overall length: 8.5.in.
Avg. air consumption: 1.7 cfm.
Air inlet: 1/4 in.
Minimum hose size: 3/8".



Art. 3002-WW

Body Saw; Air Operated

Air Tools > Air Saws

Strokes per min.: max. 9000.
Sawing depth 4 cm.
2 saw blades included.
Working pressure: 6.3 Bar (90 PSI).
Air inlet: 1/4".
Air consumption: 51 l/min (1.8 CFM).
Weight: 0.65 Kg.
Noise level: LpA = 88.15 dB (A), LwA = 99.15 dB (A).
Vibration level: ahd = 15.06 m/s², K = 1.99 m/s².
Hose inner diameter: (recommended) 10 mm (3/8").



Art. 3010-WW

Reciprocating Saw; Mini Type, Low Vibration

Air Tools > Air Saws

Strokes p/min: 9000.
Stroke: 10 mm.
Working pressure: 90 psi (9.2 bar).
Air consumption: 1.7 cfm (48.2 L/min).
Air inlet: 1/4".
Recommended air hose: Ø 10 mm (inside) / 3/8".
Length without blade: 182 mm.
Weight: 0,5 kg.
Max. cutting capacity: 1.6 mm steel.
Noise: LpA: 77 dB(A) / LwA: 84 dB(A).
Vibration: ah 3 m/s² / K=1.5 m/s².



Art. 3011-WW

Tyre Inflating Device; Digital

Blow Guns and Tyre Inflators > Tyre Inflators

Display: LCD Digital Display.
Range: 0-100bar, 0-15psi, 0-1000kpa.
Operating Temperature: -18-40C.
Accuracy: +/-1%+0.5psi.
Power Supply: TYPE R03AAA 1.5V x 2.
Hose Length: 400mm.



Art. 7452-WW

Tyre Inflating Device

Blow Guns and Tyre Inflators > Tyre Inflators

The inflation connection is separate from the inflating handle. Quality aluminium build protects the pressure gauge.

Nozzle head is offset for usability.

Hose is shrouded in a protective spring.

Pressure range: 0-11 bar (0-106psi) Length: 260 mm Weight: 1180 g.



Art. 801-UTC

Air Blow Gun with Brush Nozzle

Blow Guns and Tyre Inflators > Blow Guns

Housing Material: PA66.

Air Inlet Material: Brass.

Length (inch/mm): 5.8/148.

Weight (lbs/kgs): 0.21/0.096.

Air Inlet: 1/4" 4" Pneumatic Blow Guns with brush can be widely used for removing and cleaning dusts in work place. It would be a convenient tool for those fields: machinery workshop, wood working decor, and household.

1. With brush can clean dust and debris thorough.
2. Ergonomic design for easy work.
3. P.O.M. Composite body for light weight.
4. High quality brass inlet prolong life circle.
5. Strong wind for blow off the dust and debris.



Art. 4301-WW

Air Blow Gun Set; 3pcs

Blow Guns and Tyre Inflators > Blow Guns

Length: 110 - 300 - 500 mm.

Useful for removing dust and excess material such as drill clippings.

Supplied with UK air fitting.



Art. 4052-WW

Airburst Filter & Radiator Cleaner; 12"

Blow Guns and Tyre Inflators > Blow Guns

Delivers consistent high pressure air flow at a 90° angle to facilitate easy access in confined spaces.
5-point air delivery ensures evenly distributed cleaning and prevents damage to air filters.
Excellent for cleaning all types of filters and radiators, extending component life.
12" air comb filter and radiator cleaner.
Tube diameter: OD -12mm, ID - 6.4mm.
Stain & red anodized finish.



Art. 1407-WW

Airburst Filter & Radiator Cleaner; 24"

Blow Guns and Tyre Inflators > Blow Guns

Delivers consistent high pressure air flow at a 90° angle to facilitate easy access in confined spaces.
5-point air delivery ensures evenly distributed cleaning and prevents damage to air filters.
Excellent for cleaning all types of filters and radiators, extending component life.
24" air comb filter and radiator cleaner.
Tube diameter: OD -12mm, ID - 6.4mm.
Stain & red anodized finish.



Art. 1408-WW

Airburst Filter & Radiator Cleaner; 36"

Blow Guns and Tyre Inflators > Blow Guns

Delivers consistent high pressure air flow at a 90° angle to facilitate easy access in confined spaces.
5-point air delivery ensures evenly distributed cleaning and prevents damage to air filters.
Excellent for cleaning all types of filters and radiators, extending component life.
36" air comb filter and radiator cleaner.
Tube diameter: OD -12mm, ID - 6.4mm.
Stain & red anodized finish.



Art. 1409-WW

Airburst Filter & Radiator Cleaner; 48"

Blow Guns and Tyre Inflators > Blow Guns

Delivers consistent high pressure air flow at a 90° angle to facilitate easy access in confined spaces.
5-point air delivery ensures evenly distributed cleaning and prevents damage to air filters.
Excellent for cleaning all types of filters and radiators, extending component life.
48" air comb filter and radiator cleaner.
Tube diameter: OD -12mm, ID - 6.4mm.
Stain & red anodized finish.



Art. 1410-WW

CORDLESS POWER TOOLS

KITS & ACCESSORIES



Angle Grinder; Cordless 18v Lithium Battery

Power Tools > Other Cordless Tools

Rated Voltage: 18V.
Rotation speed: 7000 min.
Charging Time: +/-1hr.
Battery Type 1500m Ah Li-Ion.
Charger Rated Voltage 100V-240V.
Charger Frequency 60Hz.
Max. Disc Diameter: 115mm.
Drive Spindle Thread M14.



Art. 5021-WW

Polishing Machine; Cordless

Power Tools > Other Cordless Tools

For polishing of small surfaces.
Electronic speed control, variably adjustable.
Max. speed: 1500 - 3000 rpm.
Pad diameter: 100 mm.
Shaft thread: M10.
Machine weight: approx. 820 g.
Noise level:
LpA: 74 dB (A).
LwA: 85 dB (A).



Art. 7035-WW

18-Volt Lithium Cordless Drill Kit

Power Tools > Battery Series

Speed: 0-1300 RPM.
 Maximum Torque: 23Nm.
 Chuck Capacity: \varnothing 10mm.
 Includes 2 batteries



Art. 7036-WW

Impact Wrench; Cordless Lithium Battery, 1/2", 600 nm

Power Tools > Cordless Impact Wrench

Rated Voltage: 18V.
 No Load Speed: 0-2 300/min.
 Impact Rate: 0-3000/min.
 Max Torque: 600nm.
 Battery Capacity: 3000mA Li-on.
 Charging time: 2hrs.
 Includes 2 Batteries
 Included sockets: 19mm & 21mm.



Art. 2020-WW

Impact Wrench; Cordless Lithium Battery, 1/2", 540nm

Power Tools > Cordless Impact Wrench

1/2" square drive.
 Ultra fast forward and reverse function.
 LED front lamp for visibility whilst working in dark areas.
 LED battery indicator.
 540 NM of torque.
 One handed forward and reverse switch.
 Li-Ion battery.



Art. 2116-WW

Impact Wrench; Cordless Lithium Battery, 1/2", 982 nm

Power Tools > Cordless Impact Wrench

Powerful long lasting impact wrench.
 Quick switch forward and reverse function.
 LED Lamp for working in dark areas.
 LED Battery indicator.
 Torque: 982 NM.
 1/2 drive.
 Included:
 4021-WW impact wrench.
 Quick charge battery charger.
 1 x 18v 4.0 Ah Li-ION battery.
 Extra batteries available.



Art. 4021-WW

18-Volt Replacement Lithium Battery For WELZH 7036-WW

Cordless Tools > Battery Series

Replacement battery for 7036-ww.



Art. 7036-1-WW

Replacement Battery For 2020-WW

Cordless Tools > Batteries and Chargers

Replacement battery for 2020-ww.



Art. 2020-1-WW

Replacement Charger For 2020-WW

Cordless Tools > Batteries and Chargers

Replacement charger for 2020-ww.



Art. 2020-2-WW

Replacement Battery For 2116-WW & 4021-WW

Cordless Tools > Batteries and Chargers

Battery for 2116-ww and 4021-ww.



Art. 2117-WW

Battery Charger For 2116-WW & 4021-WW

Cordless Tools > Batteries and Chargers

Replacement charger for 2116-WW and 4021-WW.



Art. 2118-WW

18 Volt Lithium Battery For 5021-WW

Cordless Tools > Batteries and Chargers

Replacement battery For 5021-WW.



Art. 5021-1-WW

Replacement Charger For 5021-WW

Cordless Tools > Batteries and Chargers

Replacement Charger For 5021-WW.



Art. 5021-2-WW

Replacement Battery 10,8 V Li-Ion for WELZH 7035-WW

Cordless Tools > Batteries and Chargers

Battery pack: 10,8V Li-ion / 1.3 Ah.



Art. 7035-1-WW

AUTOMOTIVE TOOLS



Smoke Mate Smoke Diagnostic Leak Detector Machine

Body and Chassis > Body Work

Using standard mineral oil (baby oil) the SmokeMate produces a non toxic smoke which is thick enough to be seen easily for diagnostic purposes.

Due to the huge amounts of time it can take to find leaks it is often uneconomical however the SmokeMate can locate leaks in seconds allowing you more time to fix the problem and move on to the next job.

With the included adapter and optional accessories such as the Smoke Mate Bladder applications are universal allowing use on almost any vehicle.

Can be used in any industry where you need to find a leak quick - not just for the automotive industry.

Standard mineral oil is used to generate the smoke.

Small and compact.

Simple and easy to use.

Accessories: Smoke hose, cone adapters, power leads, hose plugs, storage bottle.



Art. 30891-WW

Smoke Mate Inflatable Bladder

Body and Chassis > Body Work

Pumping the bladder with air will expand it to the desired size. The design of the bladder allows it to expand and fit any shape.

Add this to the Smoke Mate to expand the amount of applications available to you.

No all intakes are conveniently round which is inefficient when trying to find a leak because of smoke escaping.

The bladder expands with air to fit almost any shape to give the most effective of blocking the intake.



Art. 1243-WW

Electric Hot Stapler

Body and Chassis > Body Work

By repairing bodywork safely and securely you can save vast amounts time and money.

Use to reinforce back to the original strength.

Can be used on bumper splits.

Temperature controlled.

Supplied with 300 staple.

Additional staples available: 1040-1-ww.



Art. 1040-WW

Dent Removal PDR Kit; 33-Piece Deluxe Paintless

Body and Chassis > Body Work

For repairing of dents e.g. hail damages, door bumps, etc.

Allows repair of dents without painting.

No need to disassemble car body parts.



Art. 1172-WW

12-Piece Plastic Connectors

Garage Equipment > Service Tools

Extra tabs used for pulling dents.
To be used with a slide hammer.

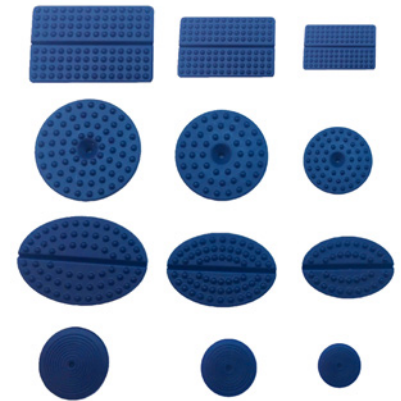

Art. 4134-WW

9-Piece Plastic Tab Connector

Body and Chassis > Body Work

Extra tabs used for pulling dents.
To be used with a slide hammer.

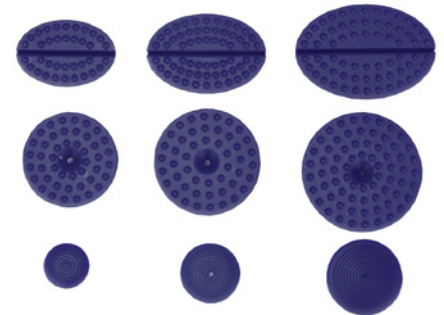

Art. 4118-WW

PDR Puller + 9-Piece Plastic Tab Set

Body and Chassis > Body Work

Extra tabs used for pulling dents.
Trigger style puller.



Art. 4123-WW

Sliding PDR Hammer Incl 9-Piece Plastic Tab Connectors

Body and Chassis > Body Work

Extra tabs used for pulling dents.
To be used with a slide hammer.
Slide hammer included.



Art. 4128-WW

Lock Out Tool Kit; Universal

Body and Chassis > Body Work

Contents include window/door seal wedges & a selection of wire catch removers & thin/thick bar removers.

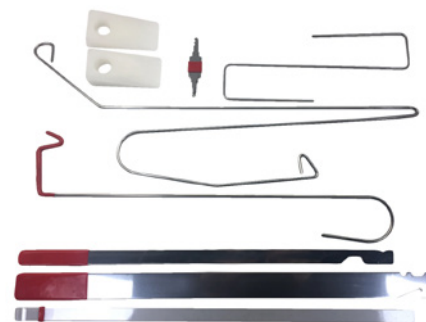

Art. 8033-WW

7-Piece Dolly Set

Body and Chassis > Body Work

A range of dolly profile heads, including: angled, heel, thin toe, double ended & more. Specifically designed for panel beating aluminium panels.



Art. 1155-WW

23-Piece Dent Removal Set

Body and Chassis > Body Work

Suitable for professional "denting doctors". Includes irons with round, flat, point and ball heads. Made of 5 to 14 mm round stainless steel. 45° up to 135° bent heads. Length: 250 mm to 1150 mm. Dip coated handles.

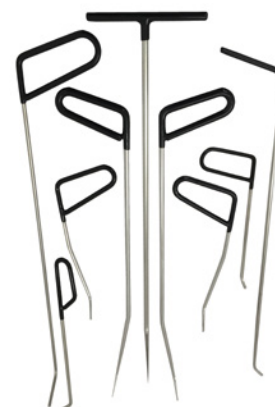

Art. 1641-WW

8-Piece Dent Removal Kit

Body and Chassis > Body Work

Suitable for professional "denting doctors". Includes irons with round, flat, point and ball heads. Dip coated handles. Supplied with transport.w

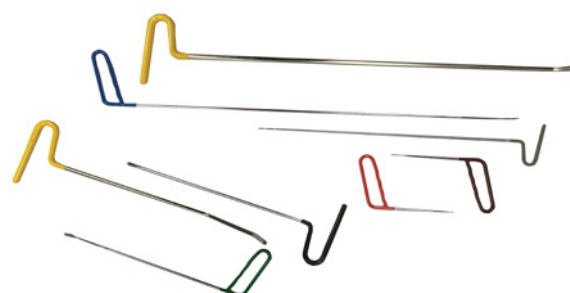

Art. 1157-WW

Trim Removal Set; Stainless Steel, 5pcs

Body and Chassis > Body Work

2-component plastic handles.

U-shape lever (inside 8.2mm / Dimension 31.5mm).

V-shaped lever 38 mm (inside 4 to 12.5 mm / 31.5 mm Dimension).

U-shape lever 13 mm (inside dimensions 6.15 mm / Dimension 12.8mm).

V-shaped lever 13 mm (1 to 4.4 mm Dimension 12.8mm).

U-shaped lever 38 mm, extra long, bent (inside 8.4mm / Dimension 31.4 mm).



Art. 4061-WW

6-Piece Extra Long Door Upholstery Trim Tools

Body and Chassis > Pry bars

For pulling clips, wires, gaskets, rings, washers & other parts.

3 x extra long shaft narrow 'u-slot' pry bars.

3 x long shaft narrow 'u-slot' pry bars.



Art. 60051-WW

Plastic Welding Kit

Art. 1242-WW

Body and Chassis > Body Work

The high costs involved in replacing the plastic panels on vehicles can be uneconomic when a quick repair using this kit could save huge costs and time.

Applications: Flame Welding, brazing, soldering, air shrinking, cutting.



Parts also available separately:

12 Piece Plastic Welding Materials for ABS **Art. 1242-4-WW**

12 Piece Plastic Welding Materials for PP **Art. 1242-5-WW**

12 Piece Plastic Welding Materials for PE **Art. 1242-6-WW**

12 Piece Plastic Welding Materials for PS **Art. 1242-7-WW**

3 Piece Reinforced Mesh, Stainless Steel, 10 x 6 cm **Art. 1242-8-WW**

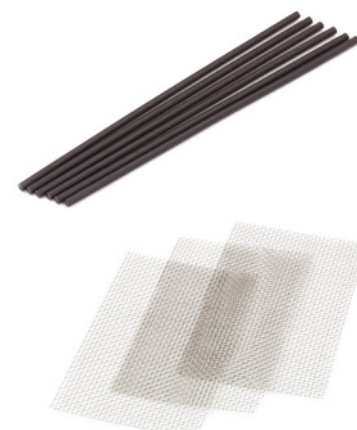

Gas Soldering Torch Kit

Body and Chassis > Body Work

Gas volume 30ml, flame temperature 1300°C.
Soldering temperature 450°C, hot air temperature 600°C.
Professional 3-in-1 soldering iron / torch / hot blower with 7 accessories:
Chisel tip, anvil tip, at tip, deflector, solder, cleansing sponge & a cap.
90w-150w equivalent electrical power.
Electronic application: soldering, heating and heat-shrinking.



Art. 5011-WW

5-Piece Inflating Air Pillow Set

Body and Chassis > Body Work

Simple but effective design allowing entry to vehicles when the keys are stuck inside.
Hand pump operated.
5 bag types included.
By slotting the pillow into the gap between the door and body the pillow can be inflated using the hand pump. The door will wedge open enough to retrieve the keys. By using a magnetic tool or gripper they keys can be retrieved easily and quickly.



Art. 4131-WW

Air Suctioned Professional Dent Puller

Body and Chassis > Body Work

Dents can now easily be removed by working the sliding hammer.
A vacuum and causes the vacuum pad firmly.
When using the pump the hammer creates.
Independent of compressed air systems.
3 Replaceable strainers:
ø 70 mm, ø 100 mm, ø 125 mm.
Holds on to the body.



Art. 1038-WW

Fender Cover; Magnetic

Body and Chassis > Body Work

Fitted magnets inside the cover to fix into place whilst working.
For protection of the paint work during repairs.
Cover size: 80x60cm.



Art. 8034-WW

8pc Removal Set

Body and Chassis > Body Work

Unique composite materials ensures that maximum force can be used without leaving scratch marks. For use on: dashboard components, door panels, wire stuffing, trim removal and lettering removal. Specially designed for the removal of car interiors & external trim.



Art. 1123-WW

Trim Tool Set; 11pcs

Body and Chassis > Body Work

Designed for fast, damage-free removal and assembly of car lining. Especially good for narrow and hard to reach working conditions. Made from fibreglass reinforced plastic.



Art. 78907-WW

Trim Tool Set ; 27 pcs

Body and Chassis > Body Work

Allows quick damage-free removal of panelling, trim and other interior components. Made from fibreglass reinforced plastic.

Includes:

- Straight slotted levers.
- Angled slotted levers.
- Straight disassembly levers.
- Angled disassembly levers.
- Scraper with trim guide.



Art. 78909-WW

Master Auto Dent Repair Kit (ALUM. Hammer)

Body and Chassis > Body Work

Designed for repairing minor dents. No need to waste time painting and filling. No difference in the colour of the paint. 9 x dent pads, specialist glue sticks. Aluminium slide hammer for difficult dents. Puller for use on flat surfaces, glue gun. Plastic scraper.

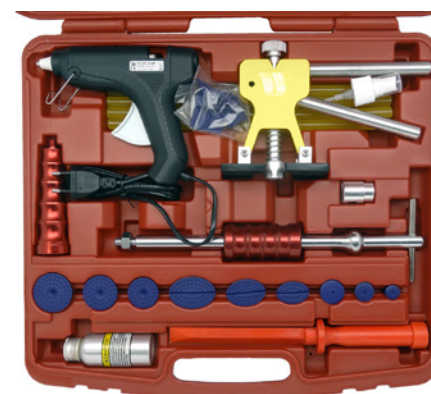

Art. 5001-WW

Cordless Electric Hot Stapler

Body and Chassis > Body Work

Cordless & rechargeable.
Supplied with 50 x0.6 mm staples in U, V and W types.
Build in LED light.
Can also be used with 0.8 mm staples.
Charge time 3-4 hours.



Art. 9103-WW

Electric Hot Stapler Hand Held Version

Body and Chassis > Body Work

New Hot Stapler Design designed for quick repair and reinforcing broken / ripped / damaged / split plastic on vehicles, motorcycles, boats, etc.
Hand held design allows for use in far greater places.
Produces a strong durable repair while still leaving plastic.
Flexible enough for correct fit.
Repairs plastic components such as:
Bumpers.
Headlight fittings.
Panel clips.
Tabs.
Plastic pins.
Spoilers.



Art. 4120-WW

Wiper Arm Puller

Body and Chassis > Parts Removal

Extraction feet distance: 10 - 30 mm.
Adjustment and pre-tensioning by cone.
Max. extraction wide: 22 mm.
Spindle: Ø 12 mm.
Pressure piece: Ø 11 mm.
Spring mechanism.



Art. 1113-WW

Easy Lock™ Wiper Arm Removal Tool

Body and Chassis > Parts Removal

The simple click and lock mechanism is much easier and faster than the traditional removers on the market.
Can be used on 99% of vehicles on the market today.



Art. 1244-WW

6-Piece Universal Wiper Arm Puller Set ****UPDATED VERSION****

Body and Chassis > Parts Removal

Comprehensive kit designed to remove a variety of wiper arms.
1232-1 Specially designed for Audi Q7 1232-2 Audi A3, A4, A5, A6.
1232-3 VW Lupo, Polo, Vauxhall Astra G, Zaphira B, Corsa C, Vectra C, Honda Jazz, CRV, FRV plus more.
1232-4 BMW 5 Series (E39), 7 Series (E38), VW Golf and Passat to 2005.
1232-5 Ford Galaxy, SEAT Alhambra, Mercedes A & B Class, VAG with internal washer nozzles.
1232-6 VW Touareg, Porsche Cayenne and other SUVs.



Art. 1232-WW

Professional Paintless Dent removal Set

Body and Chassis > Body Work

Designed for repairing minor dents.
No need to waste time painting and filling.
No difference in the colour of the paint.
Included 9 x dent pads, Specialist glue sticks.
Aluminium slide hammer for difficult dents.
Puller for use on flat surfaces.
Plastic scraper.
Glue gun.



Art. 4139-WW

Professional Paintless Dent Removal Set

Body and Chassis > Body Work

Designed for repairing minor dents.
No need to waste time painting and filling.
No difference in the colour of the paint.
Aluminium slide hammer for difficult dents.
Specialist glue sticks.
Puller for use on flat surfaces.
9 x dent pads.
Glue gun.
Plastic scraper.



Art. 800051-UTC

12-Piece Air Bag Removal Kit

Body and Chassis > Parts Removal

Made to allow the fast and safe removal of steering wheel air bags.
This kit comes with updated tools for a variety of applications.



Art. 800006-UTC

Light Cover Remover Set; 2-Piece

Body and Chassis > Headlamps and Windscreens

Easily reach and leverage light covers and other components.
A fast, damage-free solution, saving you time and money.
Works on a wide range of vehicles.



Art. 1177-WW

Mini Scraper

Body and Chassis > Headlamps and Windscreens

Ideal for removing labels, paint and stickers.
Compact design allows for use in hard to reach areas.
Comfortable fitted handle for better grip and great control.
With blade safety guard.



Art. 8941-WW

Sanding Block Kit *WerkConnect*; 20pcs

Body and Chassis > Sanding and Polishing

Six shapes for many applications.
For concave/convex and at sanding applications.
Hook and loop surface for attachment.
Tear drop sander (without hook and loop).
Suitable for use with 150mm sanding disc.

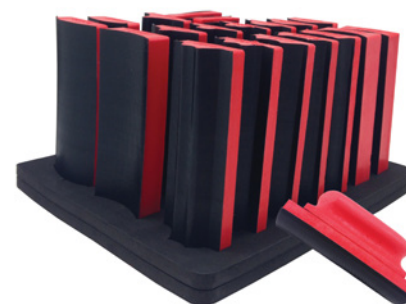

Art. 8936-WW

Hydraulic Brake Pipe Flaring Tool Kit

Brakes > Brake Pipe and Flaring

To be used for daily, professional workshop usage.
Light weight and portable.
Can be used on Aluminium, Brass and Copper lines.
Suitable for coated wires.
Included: Hydraulic ram.
Flaring tools for 4.75(3/16"), 5.00 and 6.00 mm.



Art. 1034-1-WW

Hydraulic Ram For 1034-1-WW

Brakes > Brake Pipe and Flaring

Durable hydraulic ram ideal for use with brake pipe flaring tools.
Available as part of 1034-1-WW.



Art. 1034-2-WW

Hand Held Brake Pipe Flaring Tool

Brakes > Brake Pipe and Flaring

The fastest and most convenient way to create double or single flares on brake lines.
Can be used on a variety of materials including copper, nickel and stainless steel. The ability to work in situ with the vehicle saves huge amounts of time and effort.



Art. 1210-WW

Universal Hydraulic Flaring Tool Set

Brakes > Brake Pipe and Flaring

Comprehensive hydraulic flaring kit for suitable for use on GM fuel lines, brake lines, transmission lines and air conditioning lines.

Metric bubble flaring 4.75 mm, 6 mm, 8 mm, 10 mm 45 degree double flaring 3/16", 1/4", 5/16", 3/8", 1/2" GM fuel line forming 5/16", 3/8" Push-connect forming 1/4", 5/16", 3/8".

Hand held hydraulic pump allows for easy use.



Art. 1215-WW

Hand Held Brake Pipe Flaring Tool SAE & DIN

Brakes > Brake Pipe and Flaring

The fastest and most convenient way to create single flares on brake lines.
Can be used on a variety of materials including copper, nickel and stainless steel.
The ability to work in situ with the vehicle saves huge amounts of time and effort.



Art. 1245-WW

Pipe Deburring Tool For Use On, copper | brass | steel | plastics

Brakes > Brake Pipe and Flaring

For outer and inner de-burring of metal pipes.
 Suitable for pipe internal diameter of 3 to 12 mm and pipe outside diameter of 4 to 14 mm.
 Inner cutter retractable.
 Outside cutter made of HSS steel.
 Can also be used on plastics



Art. 4002-WW

Professional Brake Pipe Flaring Tool Kit

Brakes > Brake Pipe and Flaring

Designed for fl aring of brake pipes and hydraulic lines.
 Can be used on copper, aluminium and steel lines.
 Can be for outside and inside fl aring.
 Suitable for use on both coated and non coated lines.
 Included jaws 3/16" (4.75), 1/4", 6 mm and 8 mm.



Art. 5008-WW

Universal Flaring Tool

Brakes > Brake Pipe and Flaring

For flaring thin-walled steel, aluminum and copper pipes.
 Suitable for pipe diameters: 4.75 mm (3/16 ") and 6:00 mm (1/4").
 Solid construction.
 Can be used in a bench vise.
 Includes:
 Basic unit with spindle and handle.
 4.75 mm clamping jaw.
 6:00 mm clamping jaw.
 4.75 mm flare tool (concave + convex).
 6:00 mm flare tool (concave + convex).
 Cylindrical / flat flare tool.



Art. 800075-UTC

Professional Air Brake Bleeder

Brakes > Brake Bleeding

Specialist tool for air assisted bleeding of brake and clutch systems designed to separate the fluid and air via a diaphragm.
 Connection hose also comes with a 1/4" quick coupling, 370 cm length with safety valve.
 Comes with one adaptor E20 for most common brake systems.
 Dimensions: Ø 280mm, height 460mm.
 5 litres brake fluid reservoir.



Art. 1182-WW

Adaptor for Brake Bleeder E20

Brakes > Brake Bleeding

Suitable for MAZDA 3, VOLVO C30, S40 since 2004, V50FORD Focus since 2008, Fiesta since 09.08, C-Max, Galaxy since 2006, Kuga, S-Max and other European cars with 46.5 mm filling opening.

Made of aluminium, with angled hose connector for working in tight spaces.

Works with: 1182, 4182 and 4083-WW.



Art. 1183-1-WW

Adaptor Set For Air Brake Bleeder WELZH 1182

Brakes > Brake Bleeding

This kit will expand the already numerous applications of the Air Brake Bleeder making sure you can work on almost any vehicle.

Must have accessory to Art.1182.

43.5mm Adaptor for General Motors.

43.5mm Lid for General Motors.

45mm Adaptor for universal applications.

Pressure piece for universal applications.

Euro adaptor for Audi, BMW, VW, Opel & Ford.

49.5mm Adaptor for Nissan.

34.5mm Adaptor for Nissan.

56mm Adaptor for Honda.

44.2mm adaptor for Audi, BMW.

Works with 1182, 4182, and 4083-WW.



Art. 1183-WW

3-Piece Offset Brake Bleeding Wrenches

Brakes > Brake Bleeding

N-type shape Ideal for working in hard to reach areas which is a common occurrence when working with brake lines.

Sizes: 7mm, 8mm, 9mm, 10mm, 11mm.



Art. 8023-WW

Brake Pipe Spanners; 6-Piece Set

Brakes > Brake Bleeding

Sizes: 8x9, 10x11, 12x13, 14x15, 16x17, 18x19 mm.



Art. 2483-WW

4-Piece Brake Bleeding Wrench Set

Brakes > Brake Bleeding

For easy bleeding of hydraulic clutch systems and brakes without removing the wheels saving huge amounts of time.

Convenient allowing the usually 2 man task to be operated by one.

Sizes: 8, 10, 11 mm.

1.2 metre silicone hose with check valve.

Suitable for universal bleeder nipples.



Art. 1240-WW

6-Piece Brake Bleeding Wrench Set 7-8-9-10-11 MM 6-PT

Brakes > Brake Bleeding

For easy bleeding of hydraulic clutch systems and brake systems without removing the wheels.

Allows one-person bleeding Included: 1.2 m hose, 7, 8, 9, 10, 11 mm wrenches.

Suitable for universal bleeder nipples.



Art. 4026-1-WW

6-Piece Brake Bleeding Wrench Set 7-8-9-10-11 MM 12-PT

Brakes > Brake Bleeding

For easy bleeding of hydraulic clutch systems and brake systems without removing the wheels.

Allows one-person bleeding Included: 1.2 mm hose, 7, 8, 9, 10, 11 mm wrenches.

Suitable for universal bleeder nipples.



Art. 4026-WW

4-piece Adapter Set for Air Brake Bleeder

Brakes > Brake Bleeding

For filling and bleeding brake systems through the brake fluid reservoir using brake service machines.

Adapter 90 mm, for Mitsubishi, Nissan (Gasoline), Subaru, Suzuki, Volvo S40 and V40.

Adapter 55 mm, for Chrysler, Ford Explorer, Hyundai, Mazda 6, Subaru

Adapter E20 with free moveable hose provides unrestricted access to limited spaces, for European vehicles, especially for Ford C-Max, Fiesta, Focus, Galaxy, S-Max.

Universal adapter with fastening chain.

Uses standard European air connector for connecting to brake service machines welzh 1182-WW.

Works with Welzh 4182-WW, 1182-WW & 4083-WW.



Art. 60042-WW

Manual Brake Bleeder Universal 2-Litre

Brakes > Brake Bleeding

Portable and lightweight with a 2l capacity.
Kit included and adapter to fit 90% of vehicles on the road today.
Utilised the one way siphoning method.
Pressure release valve and quick release connectors.
This is a must have kit suitable for garages, workshops and mobile repairs.



Art. 4182-WW

Manual Brake Bleeder Universal 4-Litre

Brakes > Brake Bleeding

Portable and lightweight with a 4l capacity. Kit included and adapter to fit 90% of vehicles on the road today. Utilised the one way siphoning method. Pressure release valve and quick release connectors. This is a must have kit suitable for garages, workshops and mobile repairs.



Art. 4083-WW

Replacement Adaptor: For Hose

Brakes > Brake Bleeding

For 4182-WW & 4083-WW.



Art. 4182-1-WW

Replacement Adaptor: For Plastic Housing

Brakes > Brake Bleeding

For 4182-WW & 4083-WW.



Art. 4182-2-WW

Brake Caliper Rewind Spindle; Air Operated

Air Tools > Other Air Tools

Adapter plate fully retracts into backing plate, thus particularly suitable for small brake piston distance.

Suitable for all Welzh wind back kits found in the Automotive section.

Works well with Welzh Brake Pin Adaptors (4193-WW).



Art. 1054-WW

Brake Bleeding Bottle

Brakes > Brake Bleeding

1L plastic bottle with holding chain and hook variable length bleeding hose bleeding nipple adaptor.



Art. 60058-WW

Gearless Ratcheting Caliper Press Kit

Brakes > Disk Brake Spreaders

Suitable for 1,2,4,6 & 8 Multi Piston Calipers.

3-Size Pads included:

90mm for 1 & 2 pistons.

148mm for 4 pistons.

180mm for 6 & 8 pistons.



Art. 1195-1-WW

Ratcheting Brake Caliper Press

Brakes > Disk Brake Spreaders

A truly universal solution to for separating twin and quad piston fixed callipers as well as single and twin piston floating callipers.

The ratchet is designed so it is in a central position allowing the spreading plates to spread the force evenly which prevents misalignment of the pistons.

The ratchet lever can be moved 360 degrees to allow easy access.



Art. 1195-WW

Brake Rewind Kit; Air Operated

Brakes > Brake Caliper Rewind

Air spindle suitable for left and right handed use Suitable for use on both older and newer vehicles Applications: Alfa Romeo, Audi, Citroen, Fiat, Ford, GM. Honda, Peugeot, Renault, Rover, Saab, Seat Subaru, Toyota, Volvo, VW etc. Air spindle sold separate under 1054-WW.



Art. 1211-WW

2-Piece Adjustable Brake Pin Adaptors Universal Use

Brakes > Brake Caliper Rewind

Unique and universal usage because of the special design which allows the pins to be adjusted to suit almost any 2 or 3 pin calliper.

Can be used with a hand winder or the 1054 wind back tool as shown in images. Works well with Welzh Brake Caliper Rewind Spindle; Air Operated (1054-WW).



Art. 4193-WW

Brake Caliper Wind Back Kit

Brakes > Brake Caliper Rewind

Comprehensive truly universal wind back kit designed to replace multiple tools and accessories.

Right and left hand threads - replacing separate right and left handed thread winders.

Also suitable for static press type callipers.

Universal and adjustable 4 pin adapter - replacing more than 50 adapters.

Also replaces many other adjustable and universal 2 and 3 pin adapters.

Can be used to press - replacing calliper press'.

Patented design.



Art. 60031-WW

Brake Service Master Kit; 50pcs

Brakes > Brake Caliper Rewind

Universal kit designed to be the only kit needed for a workshop or garage.

Includes 39 adapters, suitable for the majority of vehicles.

Suitable for left and right handed brake pistons.

Includes an air operated spindle.

Especially suitable for rear axle brake systems.

Included stepped adapter for from axles.

2 hexagon keys 6 + 7 mm.

2 pin punches for retaining pin on brake pad spring (Mercedes and Opel).

2 open thrust plates for badly worn out brake pads and limited working space.

4 specialist sockets.



Art. 6100-WW

Brake Service Kit; 34pcs

Brakes > Brake Caliper Rewind

The left handed thrust bolts are suitable for ford, Citroen and Renault applications.
 The precision made adapter plates with thrust bolt assembly and reaction plate; helps prevent damage to pistons and seals.
 24 calliper keys.
 Left and Right thread rewind tools.
 4 Special Reaction Plates.
 3 and 5 mm Pin Punches.
 6 and 7 mm hex keys with elongated handles.



Art. 8028-WW

Brake Rewind Pin Adaptor For Vag 3-Pins

Brakes > Brake Caliper Rewind

Updated adaptor for VAG pistons on models with EPB 3 pin brake piston wind back tool.
 Applications: VAG models, Renault Megane and Scenic and Volvo fitted with Electronic Park Brakes
 Dimensions: Outer 039mm, Pin PCD 32mm, Pin 0 3mm.

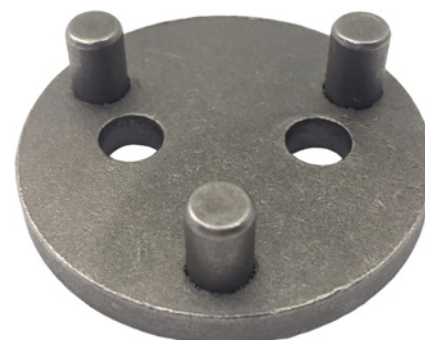

Art. 830-1-WW

21-Piece Brake Piston Wind Back Kit (INCLUDES UPDATED ADAPTORS)

Brakes > Brake Caliper Rewind

This is a multi purpose kit for setting the rear brake pistons in a huge variety of models.
 Includes special updated adaptor for use on VAG models (3-pin).
 Left and right handed spindles.
 Can be used on single, dual, triple and quad pin pistons.



Art. 830-WW

Brake Thread Repair Kit M9X1.25

Brakes > Specialist Brake Service

For repairing brake threads on Opel / Vauxhall, Ford and VAG Group vehicles.
 Includes:
 10 thread replacements.
 1 step drill.
 1 hand tap.
 1 hexagon wrench.
 Drilling gauge for VAG, 91mm.
 Drilling gauge for Opel 94 mm.
 Drilling gauge for Ford, 105 mm.

Available separately:
 Replacement Drill 4105-1-WW.
 Replacement M9*1.25 Tap 4105-2-WW.
 10 Replacement Inserts 4105-3-WW.



Art. 4105-WW

Brake Nipple Repair Kit

Brakes > Specialist Brake Service

Spend less time fitting a new calliper by repairing the bleed nipple.
By using the Nipple Treatment repair kit you can save huge amounts of money because there is no need to replace the caliper.
Drill out the old nipple, tap a new hole, replace with the replacement bleed nipple.
3 simple steps.
This exclusive design is the quickest, cheapest and easiest solution to a common problem.
Patent Pending Design.
Size: M5 & M8.



Art. 4017-WW

Brake Nipple Repair Kit +

Brakes > Specialist Brake Service

Spend less time fitting a new calliper by repairing the bleed nipple. By using the Nipple Treatment repair kit you can save huge amounts of money because there is no need to replace the caliper.
Drill out the old nipple, tap a new hole, replace with the replacement bleed nipple.
3 simple steps.
This exclusive design is the quickest, cheapest and easiest solution to a common problem.
Patent Pending Design.
Simple to Use.
Size: M8 & M12.



Art. 4017-1-WW

Replacement Nipples For 4017-WW 5-Pieces

Brakes > Specialist Brake Service

Replacement Nipples x 5 Pieces.
Size: M5 & M8.



Art. 4017-2-WW

Replacement Nipples For 4017-1-WW 5-Pieces

Brakes > Specialist Brake Service

Replacement Nipples x 5 Pieces.
Size: M8 & M12.



Art. 4017-3-WW

Electronic Brake Fluid Tester

Brakes > Specialist Brake Service

For testing brake fluid.
Applications: DOT3, DOT4, DOT5.1.
LED indicator.



Art. 78100-WW

Brake Fluid Boiling Point Tester

Brakes > Specialist Brake Service

Boil point brake fluid meter.
To test temperature value of dot3, Dot4 and 5.1.
Testing button (press and hold this button for testing).
Press instantly: Unit switch C/F.
Read five resent saved brake.
Fluid boiling temperature.
Accessory: one brake fluid.
Sucker and one measuring cup.



Art. 78101-WW

14-Piece Brake Thread Repair Kit M12x1.5 For Vag Group

Brakes > Specialist Brake Service

Suitable for use on a range of VAG Group vehicles such as Audi, SEAT, Skoda and VW.

Included:
10 threaded inserts.
1 drill guide.
1 step drill.
1 tap.



Art. 8117-WW

Spare Insert For 8117-WW

Brakes > Specialist Brake Service

Additional inserts for servicing VAG group Brake Threads.



Art. 8117-1-WW

6-Piece Brake Caliper Tool

Brakes > Specialist Brake Service

The new type of callipers feature a nut which is hard to access because of the positions of the caliper with conventional methods.

This kit provides a quick solution for many applications.

Callipers like this are normally found in VAG group vehicles such as Audi, Seat, Skoda, Porsche and Volkswagen.

The inset position of the nut can cause problems if you dont have the right tools.



Art. 4198-WW

Brake Pad Thickness Gauge Tool

Brakes > Testing and Measuring

Measures the brake pad lining on the vehicle without removing the road wheel.

Slim design enables the tool to locate the rear of the pad backing plate, allowing the probe to measure the distance between the underside of the backing plate and brake disc.

Suitable for both internal and external brake pads and features a 1.5mm and coloured check marking.

Designed for brake pads that have a normal 6mm thick lug.



Art. 4027-WW

19pc Terminal Test Kit

Electrical and Electronic > Terminal Connections

This kit should be used when testing 6 to 24 volt circuits.

Applications include alternators, cooling and heating components.

LED indicator.

Heavy duty circuit tester with 12foot cable.

6 mm male / female terminal.

5 mm male / female terminal.

3 mm male / female terminal.

2.5 mm male / female terminal.

2 mm male / female terminal.

1.2 mm male / female terminal.

0.8 mm male / female terminal.

4 mm banana adapter.

Alligator clips (red and black)



Art. 1126-WW

Electronic Stethoscope

Diagnostic > Electrical Diagnostics

Designed to help find the location of problematic noises quickly, reducing the diagnostic time 1 way amplifier allows for a quick and simple method of testing.

Padded headset and band gives extra comfort for when working for extended period of time.

Can be used on many parts of the engine including the alternator etc.

Includes 6 way amplifier and colour coded probes.

Alligator clips allows for use on various test points .



Art. 1197-WW

23-Piece Terminal Release Tool Set

Electrical and Electronic > Terminal Connections

Allows easy removal of terminals and other connectors including ABS, climate sensors, radios etc.
 Universal compatibility with a wide range of vehicles.
 Suitable for both round and tabbed connectors.
 Prevent damage during removal.



Art. 60041-WW

92-Piece Multi purpose Electronic Cable Set

Diagnostic > Electrical Diagnostics

2x potentiometer (5KOhm), to simulate temperature and throttle position sensors.
 2x LED test adapter, for testing voltage and ground signals, example: Hall sensors, injectors, solenoid valves, etc.
 2x SRS air bag simulator for electrical simulation of air bag and belt tensioner generators.
 4x test leads with banana plugs on both sides, stackable.
 4x articular probe.
 2x probes.
 2x 1-to-2 connector.
 2x alligator clips.
 24x test adapter with round plugs / round sockets, sizes 1.5 - 2.0 - 3.5 - 4.0 mm.
 48x test adapter with flat plug / flat sockets, sizes 0.7 - 0.8 - 1.2 - 2.0 - 2.5 - 3.0 - 5.0 - 6.0 mm.
 Suitable for vehicles from Europe, America and Japan.

See compatible Crimping Sets below.



Art. 1002-WW

Automotive Crimping Tool Set with 5 Pairs of Jaws

Pliers > Crimping Pliers

Crimping tool set with ratcheting function and adjustable jaws.
 Includes 5 exchangeable crimping jaws for:
 Die for Heat Shrink Butt Connector (0.5-10mm²).
 Die for Fully Insulated Quick Disconnect (0.5-6mm²).
 Die for Miniature Insulated Terminal (0.1-1.5mm²).
 Die for Insulated Flag Terminal (0.5-2.5mm²).
 Die for Closed End Connector & Heat Shrink Terminal (0.5-6mm²).
 Quick Change Ratchet Crimper.



Art. 60045-WW

Supaseal Ratchet Crimping Pliers

Pliers > Crimping Pliers

For Use With Supaseal Connectors.
 Soft Rubber Grip Handles.
 Quick Release Jaws.
 Crimping Range 0.35 to 1.5 mm² / 22 to 16AW.



Art. 60053-WW

Cordless Circuit Tester

Diagnostic > Electrical Diagnostics

Compact design with LED indicator.

No earth clips to worry about simply place the needle into the wire and touch a metal barrel to get a reading.

Applications: 3 to 28V DC.

Can be used on sensitive components such as computers.



Art. 1175-WW

Digital LCD 12-24V Wide Range Circuit Tester

Diagnostic > Electrical Diagnostics

For use on electrical circuits (12/24v) Sharp stainless steel needle allows easy access to circuits.

Can be used on cars, vans, boats, RV's and many other 12/24vcircuits.

Small ergonomic design allows for easy portability.

Digital LED display.

Cable length: 11ft.

Voltage: DG 12-24v



Art. 1126-1-WW

Digital LCD 3-49Volts Wide Range Circuit Tester

Diagnostic > Electrical Diagnostics

Includes backlit LCD display for accurate voltage reading.

For use on cars, boats, trailers, vans & commercial vehicles.

Stainless steel probe allows for easy piercing.

Reads positive & negative voltages.

Voltage: DC 3-49V.

Cable length: 11ft.



Art. 1126-2-WW

Cordless Circuit Tester; Heavy Duty

Diagnostic > Electrical Diagnostics

3-30V detection range of DC voltage.

Bi-directional polarity testing: Power and Ground.

Dual color LED indicates red for power and green for ground on 6V,12V and 24V systems.

For use on automotive, commercial vehicle and equipment repair.



Art. 1126-3-WW

Digital Multimeter

Diagnostic > Electrical Diagnostics

Suitable for the following ranges; DC: 200mV, 2V, 20V, 200V, 600V, AC: 200 - 600V.
Resistance: 200Ω, 2kΩ, 20kΩ, 200kΩ, 2MΩ.
DC Current: 20μA, 200μA, 2mA, 20mA, 200mA, 10A.
Suitable for CAT II area use.
Shock resistant casing.
Power supply: 9v.
Prop hinge



Art. 4053-WW

12-Volt Automotive Power Surge Protector

Diagnostic > Electrical Diagnostics

Housed in a hard wearing and durable case. This is a must have piece of kit for anyone working on a vehicle when plasma cutting or welding.
Prevents damage to sensitive electronics from voltage spikes.
You will save huge amounts of time as it allows the battery to be kept installed in the vehicle.
Battery clips are heavy duty and fully insulated.
Complete with indicators to show for faults.
Recommended to be used before any work on the vehicle.



Art. 4180-WW

Multi Function Automotive Test With Temperature Measurement

Diagnostic > Electrical Diagnostics

Multi-function automotive tester with temperature measurement.
Display: Illuminated Colour Screen.
Supply voltage: 8-30v dc.
Cable length: 2 metres



Art. 60033-WW

Digital Multifunction Voltage Tester

Diagnostic > Electrical Diagnostics

Voltage Range: 6-690V AC/DC.
Frequency Range: DC, 45-65Hz.
2x1.5V Alkaline Battery, AAA or Equivalent.
Accuracy: +/- (3%rdg + 3d)



Art. 60054-WW

Digital Battery Tester

Diagnostic > Electrical Diagnostics

For testing vehicle batteries, charger and starter systems.
Suitable for 12v batteries with cold start current 200 to 1000 a.
3-Digit digital voltage display.
Battery condition is shown via 3 led.
Load current:125 ampere.
Test cable length: 48



Art. 4099-WW

17-Piece Turbo System Test Set 16-22 mm

Diagnostic > Non Electrical Diagnostic

This kit has been designed to charge the turbo system with a low pressure of regulated workshop air to show the presence of leaks within the system.
Professional and economic troubleshooting.
Safety valve prevents applying to much pressure preventing damage.
Features a pressure gauge, shut off valve and pressure release valve.
This kit can also be used on cooling system hoses, turbochargers, G-Chargers.
Universal use to fit most charging systems.
This kit has been designed to fit modern engines.



Art. 1237-WW

Leakage Tester For Engine Charging Systems

Diagnostic > Non Electrical Diagnostic

This kit has been designed to charge the turbo system with allow pressure of regulated workshop air to show the presence of leaks within the system.
Professional and economic trouble shooting.
Safety valve prevents applying to muchpressure preventing damage.
Features a pressure gauge, shutoff valve and pressure release valve.
This kit can also be used oncooling system hoses, turbochargers, G-Chargers.
Universal useto fit most charging systems.
Art.
1237 is an updated kit for useon modern vehicles with smaller style hoses.



Art. 1143-WW

Suction Pump For Opel & Vauxhall

Diagnostic > Non Electrical Diagnostic

For filling the fuel system.
Is required when renewing diesel filters and other components of the diesel fuel injection system.
Prevents defects of high pressure pumps (CDI) which frequently occur renewing filters without manual filling.



Art. 1163-WW

Diesel Engine Compression Tester Kit For Common Rail Engines CRD

Diagnostic > Non Electrical Diagnostic

This is generally the preferred testing method as it avoids potential damage to the injector & prevents fuel system contamination.

Applications: alfa romeo, audi, bmw, chrysler, citroen, at, ford, honda, hyundai, jaguar, jeep, kia, land rover, lexus, mazda, mercedes, mini, mitsubishi, nissan, opel/gm, peugeot, renault, rover/mg, saab, seat, skoda, smart, suzuki, toyota, volkswagon, volvo.

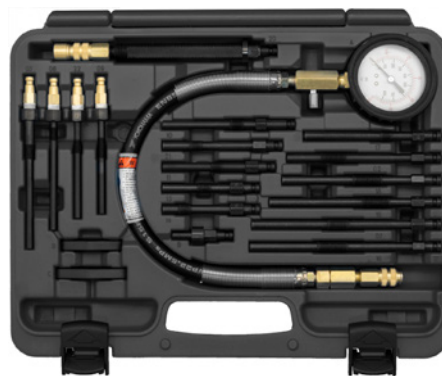

Art. 4000-WW

Replacement Compression Meter from 4003-WW

Diagnostic > Non Electrical Diagnostic

Available in set 4003-ww.



Art. 4003-1-WW

Diesel Engine Compression Master Test Kit

Diagnostic > Non Electrical Diagnostic

Designed to cover the majority of modern diesel engines.

Included:

1000 PSI 2.5" gauge.

2 pack of spare seals and nozzles.

Clamp and claw adapters.

20 dummy glow plugs.

5 injector adapters.

6 clamp on injector adapters suitable for cars, vans, LGVs, HGVs, farm vehicles and marine vehicles.

Quickly match the correct adapters thanks to the collar system.



Art. 4003-WW

Replacement Gauge From 800004-UTC

Diagnostic > Non Electrical Diagnostic

1000 PSI 2.5" gauge.

Available in set 800004-UTC.



Art. 800004-1-UTC

Common Rail Flow Meter Set Updated Version

Diagnostic > Non Electrical Diagnostic

Designed for use on the injector return side of a common rail diesel system, measures return fuel flow on engines up to ten injectors in one test.

Assists with diagnosis of: Poor or no engine starting, smoke on tick-over or acceleration, overall lack of engine power, rough running, poor acceleration.

Applications:

Bosch, Delphi, Denso, Siemens.

Art. 4106-1-WW



Common Rail Flow Meter Set

Diagnostic > Non Electrical Diagnostic

For use on common rail engines with up to 6 injectors.

Can be used on various injector brands such as Bosch, Denso, Delphi and Siemens.

Run back amount can be measured accurately via the glass tubes.

Includes 6 glass tubes, 6 measurement cartridges with 70 cm connecting lines, mounted on aluminium bar with hooks Includes 24 adaptors for Denso C3, C1, Siemens C3, Delphi, Bosch

Art. 4106-WW

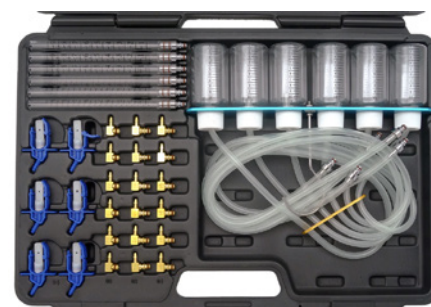

Master Diesel & Petrol Compression - Leakage Test Kit

Diagnostic > Non Electrical Diagnostic

Suitable for most petrol and modern HDi, TDCi, pump injector and older diesel engines.

Compression pressure testing up to 50 bar (725PSI) possible quick couplings in straight and angled versions, for glow plugs on Alfa, BMW, Chrysler.

Art. 7017-WW



Engine Fuel Pressure Gauge, 0-8 bar

Diagnostic > Non Electrical Diagnostic

All purpose set with precision manometer: 0.03-8 bar with tolerance +-2% For mechanic and electronic fuel injection systems 30 adaptors make this set suitable for cars including: Mercedes, BMW, Audi, Honda, Mazda, Renault, Peugeot etc.

Makes checking of leak tightness easier, system and control pressure due to 3-way valve .

Can be used for nearly all injection systems, e.g.: K-Jetronic, L/LH-Jetronic, Motronic, Motronic-Jetronic, MPFI, TBI, EFI, DIGIFANT 1/2, CIS-Digital, Weber CFI, Spi, Singlepoint, Multipoint

Art. 1208-WW



Diesel Engine Compression Tester Set

Diagnostic > Non Electrical Diagnostic

Included various adaptors (for glow plugs and dummy injectors) make this kit useful for many car types- 1 manometer (0-70 bar) (tolerance +-5%)- incl. 90° elbow- . Suitable for nearly all brands, such as: BMW, Mercedes, Ford, VW,



Art. 800004-UTC

Common Rail Diagnostic Set

Diagnostic > Non Electrical Diagnostic

For common rail engines, up to 6 injectors.
Suitable for various injector brands.
Determination of the run back volume via glass tubes or measurement cartridges.
Includes 6 glass tubes, 6 measurement.
Cartridges with 70 cm connecting lines, mounted on aluminium bar with hooks



Art. 800005-UTC

Oil Pressure Test Kit

Diagnostic > Non Electrical Diagnostic

Helps to locate faults in the oil pump system.
With many adaptors:
R 1/8" DIN 2999, 1/8" x 27 NPT, .
1/4" x 18 NPT, 3/8" x 20 UNF, 1/2" x 20 UNF.
M10 x 10, M12 x 1,5, M14 x 1,5.
M16 x 1,5, M18 x 1,5, 90°.
Scale measuring 0 – 10 bar (tolerance +-5%).



Art. 800036-UTC

Petrol Engine Compression Tester

Diagnostic > Non Electrical Diagnostic

This compression tester can be quickly set to your bike / car ,then you can get accurate readings in valves,piston rings,cylinder bores or head gaskets.
Manometer with double graduation (0 to 300 psi , 0-21 kg / cm 2) and with rubber protection to prevent scratches.
Drain valve with full copper nickel plating, anti-oxidation and corrosion.
M10 adapter is suitable for motorcycles, M12 M14 M18 adapters are suitable for car.
4 Adapters: M10x1.0mm M12x1.25mm M14x1.25mm M18X1.5mm.
Pressure gauge with rubber protection.
Pressure gauge Diameter: 75mm.
Test pressure: max 21 bar / 300 psi.
Hose Overall length: 430mm.
Pressure tube length: 150mm.
Angled pressure tube length: 160mm.
Case Size: 265 x 210 x 65mm.



Art. 800077-UTC

13-piece Alternator Pulley Bit Set

Electrical and Electronic > Charging Systems

Special Bit Set with alternator combination wrenches for assembling belt pulleys.

Spline Pulley Key, 15.0 mm, 33 teeth, bored.

Spline Pulley Key, 22.0 mm, 33 teeth, bored.

22 mm Adaptor for Belt Pulley Wrench, 30 mm.

17 mm Special Adaptor, 4 mm, 30 mm.

Bits, length 75 mm, external hexagon 10 mm (3/8") drive, internal hexagon H8 and H10 mm.

Bits, length 75 mm, external hexagon 10 mm (3/8") drive, internal serration M8 - M10.

Bits, length 75 mm, external hexagon 10 mm (3/8") drive, T-Star (for Torx) T40 and T50.

Bit Socket for Generator, 12.5 mm (1/2"), internal serration (for XZN) M10.

Bit Socket for Generator, 12.5 mm (1/2"), T-Star (for Torx) T50.

Bit Adaptor with Retaining Ball, 12.5 mm (1/2") - internal hexagon 10 mm (3/8").

Including adaptor for VW, Audi, Seat, BMW, Mercedes, Ford.



Art. 1078-WW

30-Piece Alternator Pulley Set

Electrical and Electronic > Charging Systems

1-M10 Spline Bit Socket : 120mm(L.).

1-M10 Spline Bit Socket : 140mm(L.).

1-M10 Spline Bit, 14mm Hex. Drive:

57mm(L.).

1-3/8" Dr. M10 Spline Bit Socket with 31T Nut

: 90mm(L.).

1-8mm Hexagon Bit Socket : 120mm(L.).

1-T50 TX-Star Bit Socket : 120mm(L.).

2-75mm(L.) Spline Bit : M8-M10.

2-75mm(L.) TX-Star Bit : T40-T50.

2-75mm(L.) Hexagon Bit : 8-10mm.

2-10mm Hex. Drive x H10 Bit : 50mm(L.),

70mm(L.).

1-33Teeth Alternator Nut - 15mm Hex. Tip (L.).

1-33Teeth Alternator Nut - 15mm Hex. Tip (S.).

1-33Teeth Alternator Nut - 17mm Hex. Tip.

1-33Teeth Alternator Nut - 22mm Hex. Tip.

1-17mm Hexagon Alternator Nut - inner size

:14mm.

1-1/4" Dr. 10mm Hex. Socket.

1-17mm Hexagon Alternator Nut.

1-22mm Hexagon Alternator Nut.

1-28mm x 22mm Hexagon Alternator Nut.

1-28mm x 21mm Hexagon Alternator Nut.

1-28mm x 19mm Hexagon Alternator Nut.

1-17mm x 19mm Hexagon Alternator Nut.

1-17mm x 21mm Hexagon Alternator Nut.

1-4 Points Alternator Nut with 17mm Hex. Tip.

1-3 Points Alternator Nut with 38mm Hex. Tip.

1-1/2" Dr. x 10mm Hex. Bit Holder.

Art. 60056-WW



22-Piece Alternator Pulley Set

Electrical and Electronic > Charging Systems

Special bit set with alternator appropriate sockets for assembling belt pulleys.

Includes various adaptors to fit all major brands for Mercedes, BMW, Ford, VAG, Fiat, Renault, Porsche, Vauxhall, Toyota etc.



Art. 800039-UTC

18 Piece Radio Removal Set

Electrical and Electronic > Radio and Sat Nav

For the assembly of radios and radio-navigational system for most car types and brands.

Old and new radios from Blaupunkt.

Old and new radios from Becker Radios.

Grundig Original radios in Porsche models.

Original radios in Mercedes models.

Original radios in Audi models.

Original radios in Ford models.

Original radios in BMW and Opel models.

Original radios in VW models.

Original radios in new Skoda models.



Art. 799-WW

Micro Gas Torch With 162-Piece Heat Shrink Kit

Electrical and Electronic > Terminal Connections

Range of coloured tubing with temperature range between -55°C to +125°C.
For repairing worn & damaged vehicle wiring.
Mini Butane gas torch with 6ml capacity



Art. 5010-WW

Mapp Hand Torch

Garage Equipment > Gas Torches and Heating

High intensity flame, multi-applications of brazing, solder and heating.
Lock button to keep torch lit.
Discovery CON, NBR, SUP Variable flame control knob.
Works with Mapp gas which burns 33% faster than propane gas.
Cast aluminium body Instant on/off start button Self-Lighting Torch Brass adjustable flame control knob Regulated valve helps ensure consistent flame despite angle of operation or temperature Ergonomic handle for comfort



Art. 874-WW



HUNDREDS OF NEW PRODUCTS

AND HUNDREDS MORE IN 2019

New products to come in 2019 include the "Mini Beast", our latest compact form factor impact wrench, and many more.

Connector Removal Tool VAG & Porsche

Electrical and Electronic > Terminal Connections

For the removal of VAG & Porsche connectors.
Connectors are found on MAF sensors, coil packs, headlights, fog lights, level sensors, map sensors etc.
Fits directly onto the push and pull connector.
Great Time Saver.



Art. 60080-WW

Pump For Radiator Pressure Test Kit 1005-WW

Engine Tools > Radiator Testing

Pump from 1005-WW Can be used with 1216-WW.



Art. 1005-1-WW

24 Piece Radiator Pressure And Cooling System Tester

Engine Tools > Radiator and Cooling Systems

Allows easy testing for leakage in radiator system and quick change of coolant.
Unit is suitable for domestic and commercial vehicles.
Colour coded radiator test caps make it easy to choose the suitable test cap for the job.
Special design of vacuum purge & refill tool connection fits nearly all type of radiator opening.
Test Range 0–35 psi (0–2.5 bar).
The following adapters for the following vehicles are included:
Mercedes Benz, GM, Jeep, Peugeot, Subaru, Chrysler, Acura, Mitsubishi, Nissan, Mazda, Toyota, Infiniti, Geo, Suzuki, Isuzu, Honda, Lexus, Volvo, Saab, Citroen, Renault, Fiat, Alfa, Mini Cooper, VW, BMW, Ford, Opel, Porsche, Audi, etc.



Art. 1005-2-WW

18-Piece Radiator Pressure Test Set

Engine Tools > Radiator and Cooling Systems

Applications:
Alfa Romeo, Audi, BMW, Chrysler, Citroen, Ford, Fiat, Honda, Isuzu, Mercedes, Mini, Mazda, Mitsubishi, Nissan, Saab, Seat, Skoda, Suzuki, Peugeot, Porsche, Renault, Vauxhall, Volkswagen plus many more.



Art. 1005-WW

7-Piece Updated Radiator Adaptor Set

Engine Tools > Radiator and Cooling Systems

Applications:

This addition will add newer models to the existing applications.

Alfa Romeo, Audi, BMW, Chrysler, Citroen, Ford, Fiat, Honda, Isuzu, Mercedes, Mini, Mazda, Mitsubishi, Nissan, Saab, Seat, Skoda, Suzuki, Peugeot, Porsche, Renault, Vauxhall, Volkswagen.

The 1216 adaptor kit can be used with the pump from 1005.



Art. 1216-WW

Vacuum / Pressure Pump Kit

Engine Tools > Radiator and Cooling Systems

Suitable for checking pressure and vacuum systems boost pressure, vacuum solenoid valves, tank vents, MAP sensors, etc.

Also suitable for brake bleeding.

63.5 mm pressure / vacuum gauge.

Pressure indicator range: +0 to +3 bar.

Vacuum.



Art. 4040-WW

Universal Radiator Smart Cooling System Pressure Tester Kit

Engine Tools > Radiator and Cooling Systems

User friendly 'Bladder System' valve to cover almost all radiator inlets.

Suits both bayonet and thread type cooler inlets.

Attaches to all cooling systems without adapters.

Aluminium pump with detachable tube



Art. 4219-WW

Cooling System Flushing Gun

Engine Tools > Radiator and Cooling Systems

Ensure optimum operation of cooling systems.

Allows continuous air & water adjustment without the need for solvents and harsh chemicals.

Combines the use of water with compressed air for increased cleaning capabilities.

Fitting diameters: 19, 29, 32, 36.5, 40 mm.



Art. 7054-WW

Cooling System Tester Pump

Engine Tools > Radiator and Cooling Systems

Pump from 800060-UTC.



Art. 800060-1-UTC

14-Piece Universal Cooling System Tester

Engine Tools > Radiator and Cooling Systems

Designed for testing leaks in the vehicle cooling system.
Suitable for Audi, BMW, Citroen, Ford, GM, Mercedes-Benz, Mitsubishi, Mazda, PSA, Renault, Volvo, Vauxhall, VW and many more.
Replacement Pump available under Art. 800060-1-UTC.



Art. 800060-UTC

9-Piece Truck Cooling System Tester Set

Engine Tools > Radiator and Cooling Systems

Includes pump and 7 adapters.
Can be used on the following:
DAF-XF 95, XF 105.
Scania-113, 114, 124 and 125.
Volvo-FH 12.
Iveco-Daily 2000 C-Series, Renault-Magnum.
MAN-L 2000, TGA.
Mercedes-Benz: Actros - Atego, Axor, ECO 8401, 1728.
MAN: F 90, F 2000, Iveco-EURO-Star, EURO-Tech, Euro-Truck, Strahlis.
Mercedes-Benz: Sprinter <2006, Vito.
Designed for testing the cooling system pressure.
Quick couplings.



Art. 1194-WW

Common Rail Diagnostic Set

Diagnostic > Non Electrical Diagnostic

For common rail engines, up to 6 injectors.
Suitable for various injector brands.
Determination of the run back volume via glass tubes or measurement cartridges.
Includes 6 glass tubes, 6 measurement.
Cartridges with 70 cm connecting lines, mounted on aluminium bar with hooks



Art. 800005-UTC

Injector Seat Cleaners; 17 pcs

Engine Tools > Injectors

Be used to clean and de-carbonise injector seats when changing injectors.

Suitable for a wide range of vehicles.

CONTENTS:

14mm x 14mm Flat Reamer
15mm x 19mm Flat Reamer
15.5mm x 15.5mm Flat Reamer
15.5mm x 15.5mm Angled Reamer
17mm x 17mm Angled Reamer
17mm x 17mm Flat Reamer
17mm x 17.5mm Flat Reamer
17mm x 19mm Flat Reamer
17mm x 19.5mm Flat Reamer
17mm x 20mm Flat Reamer
17mm x 21mm Angled Reamer

17.5mm x 20.5mm Angled Reamer

19mm x 21.5mm Flat Reamer

T-handle

Pilot Hex 19 x 170mm

15.5 X 250mm Cutter

2.5mm Hex Key



Art. 1014-2-WW

Injector Seat Cleaners; 6 pcs

Engine Tools > Injectors

Designed for cleaning the injector seats after replacing the injectors.

Included:

19 mm hex pilot.

15 x 19 mm reamer for use on various models.

17 x 17 mm reamer for use on BMW and PSA models.

17 x 19 mm reamer for use on Mercedes CDI engines.

17 x 21 mm offset reamer for Fiat and Iveco.



Art. 1014-WW

Injector Shaft Wire Brush Cleaning Set

Engine Tools > Injectors

This kit has been designed for universal use with most vehicles on the road now.

Specifically Developed to clean on the Injector Seat.

Essential kit when replacing injectors.

Pair with 1189-WW copper washer remover.



Art. 1231-WW

Injector Service Kit; Bosch, Delphi, Denso, Siemens

Engine Tools > Injectors

Exclusively designed for Welzh Werkzeug to allow the complete service of injectors.

Included: 19 mm hexagon pilot, 15 x 19 mm reamer, 17 x 17 mm reamer, 17 x 19 mm, 17 x 21 mm offset reamer, 2 x wire brush.

Includes the 1189-WW copper washer remover.



Art. 1224-WW

Injector Remover for Bosch Injectors; Diesel

Engine Tools > Injectors

Quickly and easily remove stubborn stuck diesel injectors.
Suitable for assembling and disassembling tightly fit common rail injectors.
Suitable for e.g. Mercedes CDI engines 611, 612 and 613.
Suitable for working in confined spaces due to the low support cylinder diameter.
Special tool construction allows to pull injector with high force.



Art. 1028-WW

Injector Removal Kit; CDI Injectors

Engine Tools > Injectors

Extra short: only 225 mm.
Suitable for e.g. Bosch Injectors, built in BMW, Mercedes-Benz with CDI engines OEM 611, 612, 613 etc.
Includes sliding hammer 1,70 kg.
Extract adapter with external thread M17 x 1.0.
Extract adapter with internal thread M27 x 1.



Art. 1030-WW

Injector Pump Puller; VAG Engines

Engine Tools > Injectors

Applications: Audi, SEAT, Skoda and VW vehicles with direct injection pump engines. Also for engines with Pump injector units.
Should be used as OEM T10133 and T10163.
Included:
Puller for dismantling FSI injectors (T10133/1).
Puller claw for dismantling FSI injectors T10133/2.
Sliding hammer T10133/3.
Cone for mounting the combustion chamber rings (T10133/5).
3 calibration tools for mounting the combustion chamber rings T10133/6, T10133/7, T10133/8.
Built-in pin for mounting the FSI injectors T10133/9.
Extractor for dismantling pump-injector units.

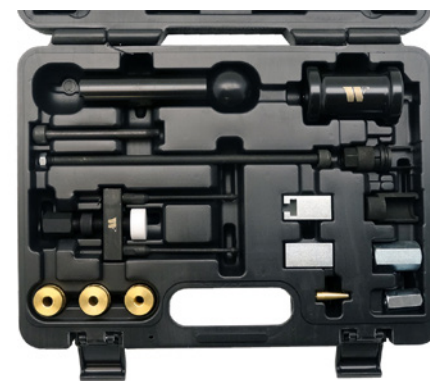

Art. 1047-WW

Injector Removal Kit; HDI Injectors

Engine Tools > Injectors

For use in the extraction of Bosch and Siemens HDI injectors. No need to remove the cylinders heads with this kit.
Suitable for vehicles with PSA 2.0i DW10/12 engines which can also be found on Toyota, Mazda and Hyundai models.
Included 2 ball bearing puller spindles 2 Open sockets for removal of the electric unit.
High performance support frame with spindle bearings.



Art. 1116-WW

Common Rail Flow Meter Set Updated Version

Engine Tools > Injectors

Designed for use on the injector return side of a common rail diesel system, measures return fuel flow on engines up to ten injectors in one test.

Assists with diagnosis of: Poor or no engine starting, smoke on tick-over or acceleration, overall lack of engine power, rough running, poor acceleration.

Applications:

Bosch, Delphi, Denso, Siemens.



Art. 4106-1-WW

Common Rail Flow Meter Set

Engine Tools > Injectors

For use on common rail engines with up to 6 injectors.

Can be used on various injector brands such as Bosch, Denso, Delphi and Siemens.

Run back amount can be measured accurately via the glass tubes.

Includes 6 glass tubes, 6 measurement cartridges with 70 cm connecting lines, mounted on aluminium bar with hooks. Includes 24 adaptors for Denso C3, C1, Siemens C3, Delphi, Bosch.

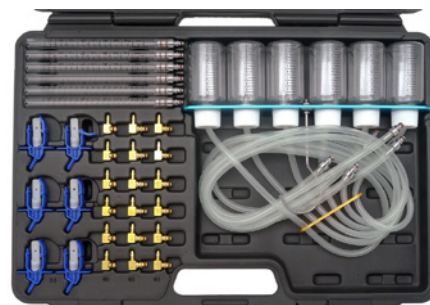

Art. 4106-WW

Injector Removal Master Kit; Bosch, Delphi, Denso, Siemens

Engine Tools > Injectors

Master kit for use on Bosch, Delphi, Denso and Siemens injectors.

Can also be used on non branded injectors.

Included are special adapters for internal and external threads.

For more modern injectors look for Art. 4199.

Slide hammer 1.6kg, 160 mm.

Slide hammer 2.7kg, 460 mm.

Slide hammer 5.1kg, 600 mm.

Pulling claw 13.7 x 18 mm, 105 mm long.

Pulling claw 12.7 x 19 mm, 130 mm long.

Slotted socket 1/2" 25, 27, 28, 29, 30 mm.

Pulling adapter Internal thread M27 x 1.0 (x3), M25 x 1.

Pulling adapter External thread M27 x 1.0 (x3).

Hammer adapter for all adapters.

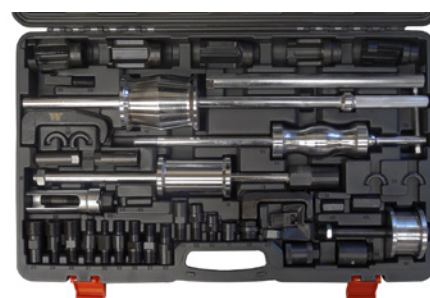

Art. 1199-WW

Injector Removal Adaptors; Universal

Engine Tools > Injectors

For pulling out hard to remove diesel injectors.

To be used with our optional sliding hammers 4212-WW.

Includes the following tools:

6 adapters for installation in the injector thread.

Inside thread M20x1.5 to inside thread M14x1.0.

Inside thread M20x1.5 to outside thread M17x1.0.

Inside thread M20x1.5 to outside thread M18x1.5.

Inside thread M20x1.5 to outside thread M20x1.0.

Inside thread M20x1.5 to outside thread M25x1.0.

Inside thread M20x1.5 to outside thread M27x1.0.

3 pulling claws with inside thread M18x1.5 and claw width 12, 13 and 16 mm -ball head adapter M18x1.5 to M18x1.10 mm int.



Art. 4199-WW

Injector Seal Extractor

Engine Tools > Injectors

A simple and quick solution to a tricky problem.
The cone shaped end has special grooves which allows the tool to grip any sizes washer in the injector bay.
The slide hammer allows even the most ceased of washers to be removed.



Art. 1189-WW

Injector Removal Tool; Vibration Hammer Edition

Engine Tools > Injectors

Specifically designed to aid the removal of seized Injectors.
To be used in collaboration with WELZH 1070-10-WW Vibration Hamer.
Also allows for manual use for restricted access.



Art. 1238-1-WW

Injector Removal Tool Kit; Vibration Hammer Edition

Engine Tools > Injectors

Specifically Designed to aid the removal of sized Injectors
To be used in collaboration with WELZH 1070-10-WW Vibration Hamer
Multiple Adaptors Included to ensure 99% Coverage
Also allows for Manual use for restricted access
Applications,
Bosch, Siemens, Denso, Delphi Injectors.



Art. 1238-WW

Removal/Installation Tool for Fuel Return Line For VAG Models

Engine Tools > Injectors

Designed to professionally disconnect/loosen as well as mount/lock the fuel return line push- t connector (round design) at the injectors.
An indispensable tool when removing fuel return line push- t connectors. Incorrect loosening may damage the connector resulting in the complete fuel return line in the engine compartment to be replaced.

Applications:

Suitable for VW-Audi, Seat and Škoda 2.0, 2.7 and 3.0 TDI Common Rail Diesel engines; as fitted to: VW Eos, Golf V, Golf VI, Jetta, Passat, Passat CC, Scirocco, Tiguan, Transporter T5, Phaeton; Audi A3, A4, A5, A6, A7, Q5; Seat Exeo; Škoda Yeti etc. (Engine codes: BMK, BPP, CAAA, CAAB, CAAC, CAAD, CAAE, CAGA, CAGB, CAGC, CBAA, CBAB, CBAC, CBDA, CBDB, CBDC, CDUD).



Art. 701-WW

38-Piece Brush Assortment Set

Brushes > Other Brushes

For cleaning and de-burring cylinders, bushings, pipes etc.
Nylon: Ø 8 - 9 - 10 - 11 - 12 - 13 - 14 - 15 - 16 - 17 - 18 - 19 mm.
1/4" drive brushes.



Art. 800044-UTC

Brush Assortment Set; 38 pcs

Brushes > Other Brushes

For polishing and cleaning machines, cars and other work pieces made of metal or plastic.
36 brushes: 8, 9, 10, 11, 12, 13, 14, 15, 16, 17, 18 and 19 mm diameter.

12x brass.
12x nylon.
12x stainless steel.
1/4" handle.
1 extender.



Art. 8007-WW

Injector Clamping Bolt Thread Repair Kit - Mercedes Benz CDI

Engine Tools > Injectors

Injector Thread Repair kit provides the special tools required to drill out the broken bolt and fit M6 threaded inserts to allow new OEM M6 bolts to be used.

Allows the task to be performed with minimal dismantling allows the cam cover to remain in place
Immense Time saving.

Size M6 threaded insert fitting kit for Use on Mercedes Benz Injector clamping bolts.

For use on: Mercedes Benz CDI engines.

Set Contains: M8x1.0mm Tap, 7-8mm step drill, 6mm drill, Drill guide, insert fitting tool & 5x threaded inserts.

Replacement Inserts Available under Art: 60013-1-WW.



Art. 60013-WW

Fuel Return Line Tool For VAG Group

Engine Tools > Injectors

Specially designed for the removal and installation of new style injector fuel return clips which is installed on return pipes used on VAG Group Piezo injectors. To remove the clips they must be unlocked before removal or they are prone to damage. This tool unlocks and removes them with ease.

Applications:

Audi A3 (2008-'10), A4 (2005-'12), A5 (2009-'12), A6 (2004-'15), A7 (2012-'15), Q5 (2009-'16), Q7 (2007-'09).

Volkswagen Passat (2008-'12), Phaeton (2004-'07), Scirocco (2008-'11), Tiguan (2007-'11), Transporter T5 (2009-'15), Eos (2008-'10), Golf VI Estate (2008-'10), Jetta (2009-'11).

SEAT Exeo (2009-'12).

Skoda Yeti (2009).

Engines Codes: 2.0 (CBAA, CBAB, CAGA, CAGB, CAGC, CBDB, CBAC, CBDC, CAAA, CAAB, CAAC, CAAD, CAAE). 2.7 (BPP). 3.0 (CDUD, BMK). 4.2 (BTR).

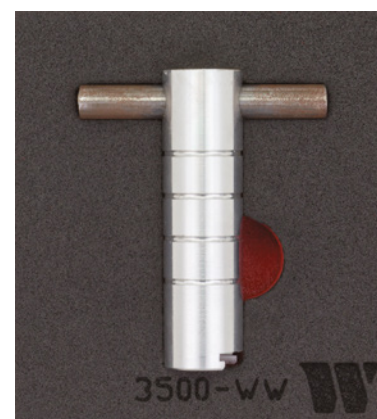

Art. 3500-WW

Injector Removal Kit with Slide Hammer and Adapters; 14 pcs

Engine Tools > Injectors

Ball joint allows hammer to be used in confined areas.

Set includes keys and deep open profile sockets for.

Dismantling injectors, and adaptors.

Allows easy and quick removal of the injector.

Includes:

Sliding hammer with shaft and handle, weight 4400g.

Ball joint adaptors.

Adaptor (internal thread): m14 x m14 - m17 x m14, m25 x m14 - m27 x m14.

Adaptors (external thread): m27 x m14 - m20 x m14.

6-Pt socket for electrical unit 25 - 27 - 29 - 30.

10 Mm hexagon bit socket with 12.5-1/2 Drive.



Art. 67307-WW

Injector Removal Kit with Slide Hammer and Adapters; 24 pcs

Engine Tools > Injectors

Diesel Injector Master Kit.

Suitable for the removal of Bosch / Delphi / Denso / Siemens and Pumpe Duse diesel injectors.

1.3kg Slide Hammer with 150mm Shaft.

4kg Slide Hammer with 400mm Shaft and Handle.

With various Male and Female Adaptors.

Pump Duse Injectors Adaptors.

Injector Sockets - 25 | 27 | 29 | 30mm.



Art. 67307-1-WW

Universal Diesel Priming & Bleeding Kit

Engine Tools > Fuel Tank and Sender

Must have kit when bleeding low pressure Diesel fuel systems.

Needed when renewing filters, pumps and other components in the injection system.

Prevents problems in high pressure pumps.

Complete with 6 adapters and a hose pump.

Applications: GM, Renault, PSA, Ford.



Art. 1176-WW

Master Fuel Connector Repair Kit

Engine Tools > Fuel Lines

Master Assortment of Fuel pipes, Hose connectors, nylon pipe, 'O' clips etc.

Designed to allow the replacement & repair of the most common sizes and Most Common Car Brands.

The set allows the technician to effectively and professionally repair the fuel connectors up to Original & OEM Standards.

Contents:

Male Snap Connectors Straight.

Male Snap Connectors Angled.

Female Snap Connectors Straight.

Female Snap Connectors Angled.

Plastic Fuel Hose.

12 x Straight couplings.

70 x Fuel Pipe Quick Connectors.

Nylon pipe in 3 ID - 2 x 6mm ID x 340mm, 6 x 8mm ID x 340mm, 2 x 10mm ID x 340mm.

Rubber Hose: 3 x 7.5mm ID x 200mm, 1 x 12mm ID x 200mm.

Twin Ear Clips: 12 x 15-18mm, 4 x 17-20mm. Plus 1 x Stainless Steel Blade Pipe Cutter.



Art. 702-WW

Injector Seat Cleaners; VAG Engines, 2.0L Common Rail

Engine Tools > Injectors

For cleaning the injector seat in 1.6 and 2.0L TDI engines in the VAG group.
For cleaning the contact surface between the injector and engine head when replacing the injector.



Art. 600023-WW

Injector Copper Seal Kit; 150 pcs

Engine Tools > Injectors

For replacing the copper washer at the base of the injector shaft on CDI engine.

Includes 10 each of the following sizes:

Ext. Ø 13.8 mm x Int. Ø 7.3 mm, 1.4 mm	Ext. Ø 15.0 mm x Int. Ø 7.5 mm, 3.0 mm
Ext. Ø 14.6 mm x Int. Ø 7.5 mm, 1.3 mm	Ext. Ø 15.5 mm x Int. Ø 7.5 mm, 2.0 mm
Ext. Ø 14.6 mm x Int. Ø 7.5 mm, 3.0 mm	Ext. Ø 16.0 mm x Int. Ø 7.5 mm, 1.5 mm
Ext. Ø 15.0 mm x Int. Ø 7.0 mm, 2.0 mm	Ext. Ø 16.0 mm x Int. Ø 7.5 mm, 1.7 mm
Ext. Ø 15.0 mm x Int. Ø 7.5 mm, 1.0 mm	Ext. Ø 16.0 mm x Int. Ø 7.5 mm, 2.0 mm
Ext. Ø 15.0 mm x Int. Ø 7.5 mm, 1.5 mm	Ext. Ø 16.4 mm x Int. Ø 7.5 mm, 2.0 mm
Ext. Ø 15.0 mm x Int. Ø 7.5 mm, 2.0 mm	Ext. Ø 20.0 mm x Int. Ø 9.4 mm, 0.9 mm
Ext. Ø 15.0 mm x Int. Ø 7.5 mm, 2.5 mm	

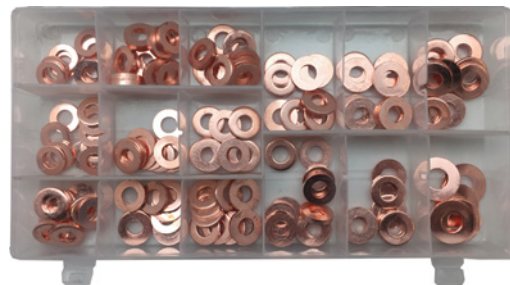

Art. 4008-WW

Injector Seal Kit; Master Kit, 551 pcs

Art. 8107-WW

Engine Tools > Injectors

Parts also available separately:

30x Ø15.0x8.0x1.5 Universal	Art. 8107-1-WW
12x Ø15.0x7.0x1.5 - Mercedes	Art. 8107-2-WW
30x Ø13.0x7.5x2.5 - Renault	Art. 8107-3-WW
30x Ø15.0x7.5x1.5 - Iveco Ford BMW MAN	Art. 8107-4-WW
30x Ø15.0x7.5x2.0 - Iveco Ford BMW MAN	Art. 8107-5-WW
30x Ø15.45x8.0x2.0 - Universal	Art. 8107-6-WW
12x Ø13.5x10x2.0 - Mazda	Art. 8107-7-WW
30x Ø15.5x7.5x2.5 - Ford	Art. 8107-8-WW
12x Ø15.5x7.5x1.5 - Land Rover	Art. 8107-9-WW
30x Ø15.0x7.5x3.0 - Renault	Art. 8107-10-WW
12x Ø13.0x7.0x1.5 - Deutz	Art. 8107-11-WW
30x Ø13.5x7.5x1.5 - Ford	Art. 8107-12-WW
12x Ø15.0x7.5x1.5 - Fiat	Art. 8107-13-WW
12x Ø15.5x7.5x1 - MAN Rover	Art. 8107-14-WW
30x Ø16.5x7.5x2 - Mercedes	Art. 8107-15-WW
12x Ø13.7x7.3x2 - Kia	Art. 8107-16-WW
12x Ø13.7x7.3x2 - Kia	Art. 8107-17-WW
50x Ø10x6.0x1.0 - steel rings	Art. 8107-18-WW
30x Ø15.8x7.5x3.0 - brass rings	Art. 8107-19-WW
20-Universal - plastic injector T-shape	Art. 8107-20-WW
Aluminium Washers x 30	Art. 8107-21-WW
30-Universal- plastic injector L-shape	Art. 8107-22-WW
Springs 25pcs	Art. 8107-23-WW



OIL SERVICING

WRENCHES & EXTRACTORS



Generation 2 Oil Filter Set 19-Piece

Art. 1130-WW

Engine Tools > Oil Filters

For use on new generation oil filters.
Effective damage free removal of a variety of oil filters.
Traditional methods can be costly because of damage to the filter.

Parts also available separately:

Oil Filter Wrench; 24 mm x 6	Art. 1130-1-WW
Oil Filter Wrench; 27 mm x 6	Art. 8107-2-WW
Oil Filter Wrench; 30 mm x 6	Art. 8107-3-WW
Oil Filter Wrench; 32.5 mm x 6	Art. 8107-4-WW
Oil Filter Wrench; 36 mm x 6	Art. 8107-5-WW
Oil Filter Wrench; 38 mm x 6	Art. 8107-6-WW
Oil Filter Wrench 16 Flutes, BMW-Volvo, 87mm, 915	Art. 8107-7-WW
Oil Filter Wrench; 64.5 x 14, For Toyota, 901-T	Art. 8107-8-WW
Oil Filter Wrench; 64.5 x 14, For Toyota, 901-L	Art. 8107-9-WW
Oil Filter Wrench; 66.5 x 14, for Ford/Mazda, 902	Art. 8107-10-WW
Oil Filter Wrench For Mercedes Benz; 74mm, 903B	Art. 8107-11-WW
Oil Filter Wrench; 87-88 mm, 901-1	Art. 8107-12-WW
Oil Filter Wrench; 3 legged, Universal, 63-83 mm, 917	Art. 8107-13-WW
Oil Filter Wrench; 100.5 mm, 05101	Art. 8107-14-WW
Oil Filter Wrench, 94.5 mm, 0595	Art. 8107-15-WW
Oil Filter Wrench, 84mm, 1284	Art. 8107-16-WW
Oil Filter Wrench, 92 mm, 0952	Art. 8107-17-WW
Oil Filter Wrench, 79mm, 0579	Art. 8107-18-WW
Oil Filter Wrench; Universal, 3 legged	Art. 8107-19-WW



Oil Filter Wrench Set; 3rd Generation

Engine Tools > Oil Filters

New Updated kit for 2019
Allows for up to 99% Oil Filter Coverage
Applications: BMW, Mercedes-Benz, Ford, Toyota, Nissan, Kia, Subaru, VAG, Mazda, Opel/
Vauxhall plus many more.
Sizes: 24 to 83mm.
Drive: 3/8".
Welzh Exclusive
All parts Available Separtley



Art. 1330-WW

Master Plastic Oil Drain Plug Kit

Oil and Fuel Tanks > Oil Tanks

Design to remove the new Style Plastic oil Sump Plugs,F
Fitted To,
VAG Group, Opel (Vauxhall) BMW
Ford, Citroen & Peugeot engines.



Art. 7050-WW

Assembly Tool for Plastic Oil Drain Plugs

Oil and Fuel Tanks > Oil Tanks

For professional loosening and tightening of plastic drain plugs.
Suitable for oil drain plugs in plastic oil pans.
Built in: Audi A1, A3, A4, A5, A6, A7, Q3, Q5, Q7, TT, TTS.
Seat Alhambra, Leon, Toledo.
Skoda Octavia, Rapid, Superb, Yeti.
VW Beetle, Caddy, CC, Golf, Jetta, Passat, Polo, Scirocco, Sharan, Tiguan, Touran.
To be used as OEM T10549.



Art. 8004-WW

Plastic Oil Drain Plug

Oil and Fuel Tanks > Oil Tanks

Designed for damage free removal of plastic sump plugs commonly found on VAG Goup vehicles.
The only solution for a damage free removal of sump plug.
1/4" drive.



Art. 8005-WW

9-Piece Generation One Oil Filter Removal Set

Jacking and Lifting > Transmission Jack Accessories

For oil filters and filter crankcase
Assortment for removal and reassembly of the oil filter and changing the filter housing
All filters are with 3 / 8" drive for Exact torque suit
Universal use On,
VAG, Opel, Renault, Toyota, PSA, Renault, Mercedes, Volvo, Ford etc,



Art. 1049-WW

Car Engine Oil Filling Device with Adaptors 11-Piece

Garage Equipment > Fluid and Extraction Equipment

New Updated Kit.
Allows for fast oil filling without spillage
Great for many late model vehicles with internal baffles
2 litre funnel fits adaptors for wide application range
Colour-coded adaptors for oil filler hole
Special angled extension with swivel feature for hard-to-reach places
Applications: Audi, BMW, Citroen, Ford, SEAT, Skoda, Peugeot, Renault, Vauxhall, VW etc.



Art. 2482-WW

16-Litre Oil Pan

Garage Equipment > Fluid and Extraction Equipment

Made from HDPE oil and fuel resistant plastic.
Impact resistant.
Diameter: 570 mm.
Height: 120 mm.
Weight: 1075g.



Art. 71001-WW

12 Volt Oil Pump

Garage Equipment > Fluid and Extraction Equipment

Max. flow rate for engine oil approx. 0,2l /min.
Ideal equipment for quick and clean oil-changes.
The oil-pump works by connecting the clamps to the 12V car battery.
Can remove 100% of the used oil if inserted through the dipstick opening.
Complete with all necessary accessories.
Max. suction lift height: 70 cm.
No suitable for fuel and other easy flammable fluids.



Art. 9910-WW

Transmission Filling Adaptors 8-Piece

Garage Equipment > Fluid and Extraction Equipment

With 9-pc adaptor set with different angles and thread types for use with different makes and models.

For filling gearboxes and differentials with oil.

Ideal for filling Mercedes.

722.9, VW / Audi DSG and CVT transmissions.



Art. 1018-2-WW

Transmission Oil Filler with 9-piece Adaptor Set 9.5Ltr

Garage Equipment > Fluid and Extraction Equipment

With 9-pc adaptor set with different angles and thread types for use with different makes and models.

For filling gearboxes and differentials with oil.

Ideal for filling Mercedes.

722.9, VW / Audi DSG and CVT transmissions.

Hose length 160 cm.

9.5l capacity. w



Art. 1018-1-WW

70 Litre Waste Oil Drain Receiver

Garage Equipment > Fluid and Extraction Equipment

Designed for containing waste oils, such as on engines, gearboxes, rear axles, etc.

Compressed air connection, makes it easier to empty the container without oil spillage.

Hopper capacity: 8 litres (Ø 48 cm).

4 castors, 2 swivel wheels for easy manoeuvring (Ø 150 / 75 mm).

Includes emptying hose.

Length 165 cm.

Min. Height: 112 cm.

Max. Height: 162 cm.

Container: Ø 41 cm / height 82 cm.



Art. 60072-WW

70 Litre Mobile Suction Evac Oil Drainer, Air support

Garage Equipment > Fluid and Extraction Equipment

Sucking speed: 0.6-1.6L/Min.

Work pressure: 7-8Bar.

Collecting height: 1.85m.

Tack capacity: 90L.

Capacity of measuring cup: 10L.

Length of suction pipe: 1.5m.

Length of drainpipe: 2.0m.

Total weight: 37kgs.

Overall dimension: 500x500x500.

Fixed wheel: 7".

Swivel castor: 4".

Function: Multi-function: oil sucking, oil collecting & oil filling.

Additional large oil tray convenient for oil collecting.

Easy use to drain oil in low pressure.

Transparent measuring cup for easy oil observation.

Different type of nozzles is equipped for various condition.



Art. 60073-WW

FLUID EXTRACTORS

COLOUR CODED FOR EFFICIENCY



Suction & Filling Car Fluid Syringe

Garage Equipment > Fluid and Extraction Equipment

1.5Ltr Capacity.
Can be used on oil, brake fluid, transmission fluid, water and other fluids found in vehicles.
Not suitable for fuel.
Reduces spillage and mess.



Art. 1169-WW

Fluid Transfer / Extractor Pump Set

Garage Equipment > Fluid and Extraction Equipment

Works for Transferring or Siphoning All Types of Automotive Fluid. Quickly removes transmission oil from automatic transmissions that are over filled.
Also works great for adding oil to differentials. Translucent 1.1 Quart /1.1 Litre capacity cylinder body is marked in both English and metric.
Includes two valves; a shut off valve for transferring fluids and a siphon valve with intake and discharge hoses, ideal for removing anti-freeze.
Disassembles for easy cleaning, enabling use with multiple fluids.
High quality viton seals stand up to caustic fluids.



Art. 1179-WW

Syringe for Fluid and Oil; 200 cc

Garage Equipment > Fluid and Extraction Equipment

Suitable for oil, brake fluid, water, screen wash, and many other fluids.
Not suitable for fuel.
200ml capacity.



Art. 1184-WW

Suction & Filling Syringe For Diesel Fuel Systems Incl 3 Adaptors

Garage Equipment > Fluid and Extraction Equipment

Designed to be used to bleed both diesel and petrol engines when extracting excess fuel from fuel lines before maintenance.
Comes with 3-Piece quick connectors For Diesel Systems.
Reduced damage and spillage.



Art. 1200-WW

AdBlue Syringe 1.5L

Garage Equipment > Fluid and Extraction Equipment

Designed to allow the filling of adblue fluid to commercial vehicles.
Separate container prevents contamination.
1.5L capacity.



Art. 1201-WW

Oil Filter Wrench For Opel

Engine Tools > Oil Filters

For use on Opel / Vauxhall oil filters with engine codes beginning with A and Z.
The special design allows for easy access to the filter cap.
Models: Astra-G (1998-2003), Astra-H 2004 (2004-2009), Insigna 2009 (2009-), Omega-B 1994 (1994-2003), Signum 2003 (2003-2008), Speedster 2001 (2001-2006), Vectra-B 1996 (1996-2002), Vectra-C (2003-2008), Zafira-A 1999 (1999-2004), Zafira-B 2005 (2005-2010).
Codes: A 20 NHT (LDK), Z 20 NET (L850Turbo), Z 22 SE (L850), Z 22 XE (L850), Z 22 YH (L850 DI).
OEM code: KM-6150.
1/2" drive.



Art. 1217-WW

Oil Filter Cap Wrench Ø64.5mm x 14 Flutes - Lexus/Toyota *Heavy Duty Design*

Engine Tools > Oil Filters

For most Toyota 1.8 & 2.0L 4-cylinder engines.
Applications: Toyota Auris, Corolla, Prius and Premio.
Aluminium.
10 (3/8) drive.



Art. 4067-WW

30-Piece Oil Filter Wrench Kit

Engine Tools > Oil Filters

3 leg oil filter wrench Ø 65 mm - Ø 120 mm
Adaptor 10 mm (3/8") x 12.5 mm (1/2")
65 mm x 14-pt: for Daihatsu, Toyota, Nissan, Fiat
65 / 67 mm x 14-pt: for Daihatsu, Toyota
66 mm x 6-pt: for Fiat Punto 1.2, Renault
68 mm x 14-pt: for Mazda, Ford Escort, Subaru
73 mm x 14-pt: for Toyota, Lexus
74 mm x 15-pt: for Audi, GM, Rover, Chrysler
74 / 76 mm x 15-pt: for Ford, Opel, VW, Audi, Mercedes
75 / 77 mm x 15-pt: for VW, Audi, Ford, Isuzu, Mercedes, Opel
76 mm x 8-pt: for Fiat Marea, Lancia Delta
76 mm x 12-pt: for Fiat, Renault, Mercedes
76 mm x 14-pt: for VW, Mercedes, Porsche, BMW, Audi, Opel
76 mm x 30-pt: for Ford, Motorcraft FL400A
78 mm x 15-pt: for Nissan, Ford, Toyota
80 mm x 15-pt: for Nissan, Honda, Opel, Mazda
80 / 82 mm x 15-pt: for Subaru, Toyota, Honda, Mazda,

Nissan
86 mm x 16-pt: for Volvo S40 / S60 / S70 / S80
86 mm x 18-pt: for VW, Audi, Renault, Peugeot, Citroen
90 mm x 15-pt: for Subaru, Toyota, Honda, Mazda, Nissan
92 mm x 10-pt: for Fiat, Lancia
93 mm x 15-pt: for Mazda, Volvo, Mitsubishi, Nissan, Honda
93 mm x 36-pt: for Ford, Motorcraft FLINFLA 1B, FL3001, FL320
93 mm x 45-pt: for VW, Audi
95 mm x 15-pt: for Toyota, Alfa, GM, Ford, Chrysler
96 mm x 18-pt: for VW, Renault
100 mm x 15-pt: for Isuzu, Mitsubishi
106 mm x 15-pt: for Fiat Ducato 2.5D
108 mm x 15-pt: for Volvo Diesel C70 / S70 / N70 / 850 Tdi
108 mm x 18-pt: for Renault Espace / Laguna / Master / Safrane / Traffic 2.4+2.5+2.8D+Tdi



Art. 5009-WW

Oil Filter Wrench DSG/VAG - Stubby Version

Engine Tools > Oil Filters

Oil Filter Wrench DSG/VAG - Short Version.
Stubby version (100mm) is designed for models fitted with common rail diesel engines with DSG gearboxes.
The oil change can be done without the need for removing the battery.
Time Saver.
24mm Bi Hex.
1/2"Dr.



Art. 5024-WW

Oil Filter Wrench DSG/VAG

Engine Tools > Oil Filters

Oil Filter Wrench DSG/VAG.
Designed for changing the oil filter on VAG Vehicles fitted with DSG Gearboxes.
The oil change can be done without the need for removing the battery.
Time Saver.
24mm Bi Hex.
1/2"D.
Stubby Version available for Models fitted with DSG Gearboxes with common rail engines.



Art. 5025-WW

Universal Oil Filter Funnel

Engine Tools > Oil Filters

The attached bayonet adapter is suitable for a huge range of applications. Can be used on BMW, Audi, Volkswagen, Seat, Skoda, Toyota, Mitsubishi. Simple and easy solution to a mess and spill free oil change. The universal adapter allows the biggest range of applications.



Art. 60027-WW

Oil Filter Wrench For 27 mm

Engine Tools > Oil Filters

Designed especially for removing the oil filter housing on Ford 2.2 Duratorq diesel engines from 2010 with engine code DW12C. Applications. Ford 2.0 TDCi Duratorq with DW10C engines from 2010. Ford 2.2 TDCi Duratorq with DW12C engine.



Art. 60025-WW

7-Piece Low Profile Oil Filter Wrench Set

Engine Tools > Oil Filters

Drive: 3/8".
Sizes:
24mm (misc. BMW).
27mm (Mercedes A-Class).
29mm (misc.).
30mm (misc.).
32mm (Opel Astra G, Corsa B, Zafira).
36mm (misc. BMW, Ford Mondeo 2.0, Transit 2.0D, Opel Vectra B, Zafira, misc. Mercedes).
38mm (Opel Vectra 2.0D).



Art. 60044-WW

Oil Filter Chain *Professional Use* 60-115 mm

Engine Tools > Oil Filters

Pro version with duplex chain.
Chain width 13 mm.
For every day workshop use.
For rusted oil filter.
Easy handling.
Suitable for all steel filter cartridges with diameter 60 - 115 mm.



Art. 7071-WW

Oil Filter Wrench 3-Leg

Engine Tools > Oil Filters

Use With 1/2"dr Ratchet.
Size: 65-mm - 110-mm.



Art. 800076-UTC

Oil Filter Wrench; Universal, 60-80 mm

Engine Tools > Oil Filters

For the removal of oil filter from 60-80mm.
Grooved edges ensure a tight grip on any style of filter.
Can be used with a 1/2" ratchet.



Art. 821-WW

Oil Filter Wrench; Universal, 80-98 mm

Engine Tools > Oil Filters

For the removal of oil filter from 80-98mm.
Grooved edges ensure a tight grip on any style of filter.
Can be used with a 1/2" ratchet.



Art. 822-WW

Oil Filter Wrench; Universal, 100-140 mm

Engine Tools > Oil Filters

For the removal of oil filter from 100-140mm.
Grooved edges ensure a tight grip on any style of filter.
Can be used with a 1/2" ratchet.



Art. 823-WW

40-Piece Glow Plug Removal Kit M8-M10

Engine Tools > Glow Plugs

For removing damaged and broken glow plugs from cylinder heads
Ideal for use where a glow plug has sheared off just below the hex, or flush with the cylinder head.
Removes 8mm & 10mm glow plugs (M8 x 1.0 thread or M10 x 1.0 thread).
6 x extractor sockets.
1 x dual size high tensile step drill.
1 x narrow pulling unit set.
1 x drill holder extension.
2 x taps.
2 x drill bits.
2 x glow plug chamber cleaning brushes.



Art. 1069-WW

Impact Vibration Glow Plug Removal Gun Incl Sockets 8-12 mm

Engine Tools > Glow Plugs

The impact wrench is designed to deliver low torque in 4 stages (10, 20, 30, 40 nm).
The use on vibrations and torque will allow easy removal of stuck glow plugs.
The level of torque will stop the shearing of the glow plug head.
Impact Gun: 20 to 40nm.
Deep Sockets: 8, 9, 10, 11, 12 mm.
Extension Bars 50 & 100mm.
Universal Joint.
1/4" Drive.



Art. 4121-WW

Universal Glow Plug Extraction Master Kit

Engine Tools > Glow Plugs

With the top of the glow plug damaged i.e. snapped off getting the glow plug can be a very awkward and expensive task.
This kit has been developed to save huge amounts of effort and costs. Must have innovative kit.
Complete kit for glow plugs electrode extraction: M8 x 1.0, M9 x 1.0, M10 x 1.0 and M10 x 1.25
Includes all the necessary tools: (9 x extraction rods, 4 x glow plug guides and 1 x slide hammer) for safely removing the terminal part of the glow plug electrode without damaging the cylinder head.



Art. 4069-WW

33-Piece Glow Plug Thread Repair Kit

Engine Tools > Glow Plugs

Designed for repairing glow plug threads in the cylinder head.
Applications M8x1.0, M10x1.0, M10x1.0, M12x1.25.
Included 6 x taps.
20 thread repair coils.
2 x coil drivers.
3 centering drivers.
1 guide pin.



Art. 4114-WW

Glow Plug Thread Repair Kit M8, M9, M10, M12

Engine Tools > Glow Plugs

For repairing the glow plug mounting thread in the cylinder head.

Includes:

5x reamer for reaming the original thread.
M8 x 1.0 - M9 x 1.0 - M10 x 1.0 - M10 x 1.25 - M12 x 1.25.

5x taps for threaded sleeves.

M8 x 1.0 - M9 x 1.0 - M10 x 1.0 - M10 x 1.25 - M12 x 1.25.

5x taps for trimming the original thread.

M8 x 1.0 - M9 x 1.0 - M10 x 1.0 - M10 x 1.25 - M12 x 1.25.

Assembly tools for inserting the threaded sleeves.

5x threaded sleeves M8 x 1.0 (11 mm long).

5x threaded sleeves M9 x 1.0 (11 mm long).

5x threaded sleeves M10 x 1.25 (12 mm long).

5x threaded sleeves M10 x 1.0 (12 mm long).

5x threaded sleeves M10 x 1.0 (19 mm long).

5x threaded sleeves M12 x 1.25 (12 mm long).

5x threaded sleeves M12 x 1.25 (19 mm long).

5x threaded sleeves M12 x 1.25 (26 mm long).



Art. 60074-WW

Glow Plug Removal Set for Damaged Glow Plugs

Engine Tools > Glow Plugs

Simplifies the assembly and disassembly and professional repair of glow plug threads extractor for fixed glow plugs.

Step drill to drill out damaged glow plugs 7 x 5.5 mm and 9 x 5.5 mm.

Tap for regrooving of the glow plug threads: M8 x 1.0 mm - M10 x 1.0 mm - 6.3 mm (1/4") x 28UNF.

Holder for thread tap with ratchet function.

E-type socket E10.



Art. 7087-WW

Damaged Glow Plug Removal Set

Engine Tools > Glow Plugs

Simplifies the assembly and disassembly and professional repair of glow plug threads extractor for fixed glow plugs.

Step drill to drill out damaged glow plugs 7 x 5.5 mm and 9 x 5.5 mm.

Tap for regrooving of the glow plug threads: M8 x 1.0 mm - M10 x 1.0 mm - 6.3 mm (1/4") x 28UNF.

Holder for thread tap with ratchet function.

E-type socket E10.



Art. 80007-UTC

Ratcheting Exhaust Cutter

Engine Tools > Exhaust Tools

For use on pipe with a diameter of 34-67 mm.

Cutting depth 3 mm.

Ratchet has 60 teeth with 6 degrees between each click.

Spare blades available under Art. 1125-P1.



Art. 1125-WW

Exhaust Expander Set 3-Piece

Engine Tools > Exhaust Tools

Designed to expand heated pipes.
Used for the install of new exhaust pipes on older components.
Expander 1, spread range from 31 to 44 mm.
Expander 2, spread range from 39 to 61 mm.
Expander 3, spread range from 54 to 87 mm.

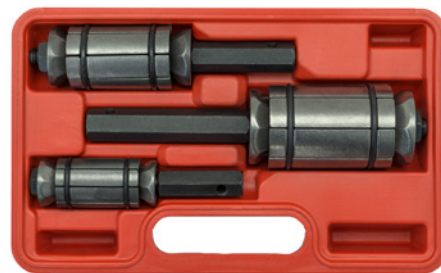

Art. 800054-UTC

Universal Diesel Priming & Bleeding Kit

Engine Tools > Fuel Tank and Sender

Must have kit when bleeding low pressure Diesel fuel systems.
Needed when renewing filters, pumps and other components in the injection system.
Prevents problems in high pressure pumps.
Complete with 6 adapters and a hose pump.
Applications: GM, Renault, PSA, Ford.



Art. 1176-WW

Fuel Gauge & Pump Sender Collar Wrench

Engine Tools > Fuel Tank and Sender

Designed for the removal and refitting of fuel gauge sender collars.
The adjustable style of the jaws allows for various applications.
Range: 89 to 170 mm.
Damage free method of removing collars.
To be used with a 16 mm socket or wrench.



Art. 1192-WW

Turbo Actuator Adjustment Set - VAG

Engine Tools > Turbo and Charging Systems

This tool set is designed for the professional loosening, adjustment and tightening of the control rod when removing/installing the pressure capsule along with the charge pressure actuator position sensor.

Suitable for the pressure capsule with charge pressure actuator position sensor at the exhaust gas turbocharger fitted to 2.0 l Common Rail Diesel engines.

For example found in: Golf VI (5K), Golf Plus (52), Jetta (1K), Passat (3C), Passat CC (35), Scirocco (13), Eos (1F), Tiguan (5N), Transporter T5 (from 2010 onwards, 7J, 7H, 7G, 7F) and Audi A3 (8P).



Art. 60078-WW

Universal Valve Spring Installer and Remover Tool Set

Engine Tools > Engine Valves

Designed for the assembly and disassembly of valve springs or when replacing the valve stem. This kit is designed to work without removing the cylinder head. Valves will be closed using pressurised air preventing falling into the combustion chamber. Perfect for working in confined areas.

Applications:

Mercedes-Benz: M102, M103, M104, M111, M112, M113, M271, M272.

BMW: N42, N52, N62, M54, M52, M56, E38, M60, V8.

Can also be used on many other European, American and Japanese vehicles.



Art. 4014-WW

Mercedes Benz Valve Adjusting Wrench

Engine Tools > Engine Valves

Suitable for use on Mercedes-Benz models: M100, 110, 113, 115, 123, 130.
1/2" drive, 17 mm.



Art. 4191-WW

Valve Lapping Tool Attachment

Engine Tools > Engine Valves

Facilitates the insertion of valves.

Automatic change in direction.

For use with fine grinding paste.

With 8 mm shank for holding in drill machine.

Working speed min. 1000 rpm to max. 1250 rpm.

4 different suction plates in 20, 30, 35 and 40 mm.

13 mm shaft for attaching the suction cups.



Art. 5018-WW

21-Piece Oil Drain Plug Key Set

Engine Tools > Oil Tanks

Included:

9 hexagon sockets: 8-9-10-12-14-17 mm, 5/16", 3/8", 1/2".

8 square sockets 8-11-12-13-14 mm, 5/16", 10 (3/8), 12,5(1/2).

1 inner square socket 10 mm.

1 triangle socket 10mm.

1 spline socket M16.

1 sliding T-bar 200 mm.

Can be used with air tools.



Art. 4208-WW

Dipstick for Audi and VW with Oil Level Indicator

Engine Tools > Oil Tanks

Suitable for Audi and VW models with oil level indicator in the display.
An unnoticed defect of the display without manual oil level check could cause engine failure.
Useful tool after exchange of the oil sensor or to calibrate the driver's display.
Applications:
3.0 and 2.7 L TDI - 2.0 TDI - 1.8 and 2.0 TFSI - 3.0 and 3.2 TFSI.
OEM T40178.



Art. 5000-WW

4-Piece Oil Dipstick Set For Mercedes Benz

Engine Tools > Oil Tanks

Necessary after changing the oil as the manufacturer does not supply them as standard.
A - 1220 mm For transmission oil (722.6).
B - 920 mm For transmission oil (722.7, 716.6).
C - 930 mm Motor oil (103.943/984/985, 104, 111, 119, 120,137, 603.913/963/97, 604, 605, 606, 611,612, 613, 628, 612.965).
D - 930 mm Motor oil (M112, 113, 646, 647, 648).



Art. 800055-UTC

4-Piece Oil Dipstick Set For Mercedes Benz

Engine Tools > Oil Tanks

Necessary after changing the oil as the manufacturer does not supply them as standard.
A - 1220mm - For transmission Oil - 722.6
B - 920 mm - For transmission oil - 722.7, 716.6
C - 930 mm - Motor oil - 103.943/984/985, 104, 111, 119, 120,137, 603.913/963/97, 604, 605, 606, 611,612, 613, 628, 612.965.
D - 930 mm - Motor oil - M112, 113, 646, 647, 648.



Art. 4132-WW

2-Piece Fuel Filter Tool for Diesel JTD / CDTi / DDiS / TiD / VCDi / Hdi

Engine Tools > Fuel Filters

Designed to remove the filter cap without damage. Must have tool, huge time and money saver. Applications:
Chevrolet Captiva 2.0 VCDi 2007.
Chevrolet Epica 2.0 VCDi 2008.
Citroen Relay 2.0,2.2,2.8,3.0 Hdi 2002.
Fiat 500 1.3 JTD 2007.
Fiat Doblo 1.3 JTD 2004-2010.
Fiat Ducato 2.0,2.2,2.3,2.8,3.0 JTD 2002.
Fiat Idea 1.3,1.9 JTD 2004.
Fiat Multipla 1.9 JTD 2002-2010.
Fiat Panda 1.3 JTD 2004.
Fiat Punto 1.3,1.9 JTD 2001-2010.
Fiat Sedici 1.9,2.0 JTD 2006.
Peugeot Boxer 2.0,2.2,2.8,3.0 Hdi 2002.

Saab 93 1.9 TiD 2004-2006.
Suzuki Splash 1.3 DDiS 2008.
Suzuki Swift 1.3 DDiS 2005.
Suzuki SX4 1.3 DDiS 2006.
Vauxhall Agila 1.3 CDTi 2008.
Vauxhall Astra 1.3,1.9 CDTi 2004-2010.
Vauxhall Corsa 1.3 CDTi 2003-2006.
Vauxhall Combo 1.3 CDTi 2004.
Vauxhall Meriva 1.3 CDTi 2005-2010.
Vauxhall Signum 1.9 CDTi 2004-2008.
Vauxhall Tigra 1.3 CDTi 2004-2009.
Vauxhall Vectra 1.9 CDTi 2004-2008.
Vauxhall Zafira 1.9 CDTi 2005.



Art. 60026-WW

Fuel Filter Removal Tools for Ford Transit (Custom)

Engine Tools > Fuel Filters

Due to the awkward and hard to reach location of the fuel filter traditional methods are ineffective. This can potentially damage the filter housing which can be quite costly.

1/2" Suitable for use on: Transit (2013 >), Transit Custom (2012 >), Tourneo (2012 >).



Art. 4084-WW



Fuel Filter Removal Tool For VW Crafter & Volvos

Engine Tools > Fuel Filters

Volkswagen Crafter 2.5 TDi from 2006 to 2013, Volvo 4 and 5 cylinder 2.0lt and 2.4lt diesel engines, V70, XC70, S40, S60, S80, XC90, V50.

Engine codes: AUH, BCQ, BJJ, BJK,BJL, BJM, CEBA, CEBB, CECA, CECB.

OEM Codes: OEM T50011 & 999 7084.

OEM filter number 2E0 127 159.



Art. 4087-WW



Fuel Filter Removal Tools for PSA Group 2.2 HDi Engines

Engine Tools > Fuel Filters

Due to the awkward and hard to reach location of the fuel filter traditional methods are ineffective. This can potentially damage the filter housing which can be quite costly.



Art. 4088-WW



Fuel Filter Removal Tools for Mercedes Benz 2.2 CDI

Engine Tools > Fuel Filters

Due to the awkward and hard to reach location of the fuel filter traditional methods are ineffective. This can potentially damage the filter housing which can be quite costly.



Art. 4089-WW



UFI Fuel Filter Cover Installation Lever

Engine Tools > Fuel Filters

The unique feature of this tool is to allow re-assembly of the filter housing without bending or damaging the gasket face when removing the filter.

Most commonly found on VAG Group vehicles with 2.0l TDI common rail engines.

The huge savings in cost can allow this tool to pay for its self in just one use.

The non use of this tool can lead to further more costly problems if the filter us replaced damaged.



Art. 60029-WW

Removal/Installation Tool for Fuel Return Line For VAG Models

Engine Tools > Fuel Lines

Designed to professionally disconnect/loosen as well as mount/lock the fuel return line push- t connector (round design) at the injectors.

An indispensable tool when removing fuel return line push- t connectors. Incorrect loosening may damage the connector resulting in the complete fuel return line in the engine compartment to be replaced.

Applications:

Suitable for VW-Audi, Seat and Škoda 2.0, 2.7 and 3.0 TDI Common Rail Diesel engines; as tted to: VW Eos, Golf V, Golf VI, Jetta, Passat, Passat CC, Scirocco, Tiguan, Transporter T5, Phaeton; Audi A3, A4, A5, A6, A7, Q5; Seat Exeo; Škoda Yeti etc. (Engine codes: BMK, BPP, CAAA, CAAB, CAAC, CAAD, CAAE, CAGA, CAGB, CAGC, CBAA, CBAB, CBAC, CBDA, CBDB, CBDC, CDUD).



Art. 701-WW

Master Fuel Connector Repair Kit

Engine Tools > Fuel Lines

Master Assortment of Fuel pipes, Hose connectors, nylon pipe, 'O' clips etc.

Designed to allow the replacement & repair of the most common sizes and Most Common Car Brands.

The set allows the technician to effectively and professionally repair the fuel connectors up to Original & OEM Standards.

Contents:

Male Snap Connectors Straight.

Male Snap Connectors Angled.

Female Snap Connectors Straight.

Female Snap Connectors Angled.

Plastic Fuel Hose.

12 x Straight couplings.

70 x Fuel Pipe Quick Connectors.

Nylon pipe in 3 ID - 2 x 6mm ID x 340mm, 6 x 8mm ID x 340mm, 2 x 10mm ID x 340mm.

Rubber Hose: 3 x 7.5mm ID x 200mm, 1 x 12mm ID x 200mm.

Twin Ear Clips: 12 x 15-18mm, 4 x 17-20mm. Plus 1 x Stainless Steel Blade Pipe Cutter.



Art. 702-WW

Cylinder Head Leakage Tester Replacement Fluid

Engine Tools > Cylinder Heads

Contrast fluid to be used with 8016-WW.



Art. 8016-1-WW

Automotive Tools

Cylinder Head Leakage Tester

Engine Tools > Cylinder Heads

Able to diagnose presence of CO2 in cooling system for cracked cylinder head and blown gasket without removing any engine parts.
CO2 test fluid changes from blue to green (or yellow) if CO2 is detected in cooling system.
Provided with a high quality test liquid made in the USA and an extra bottle to store the used liquid.
Fluid Sold Separately: 8016-1-ww.



Art. 8016-WW

SPECIALIST TOOLS & SETS

TIME SAVING TOOLS

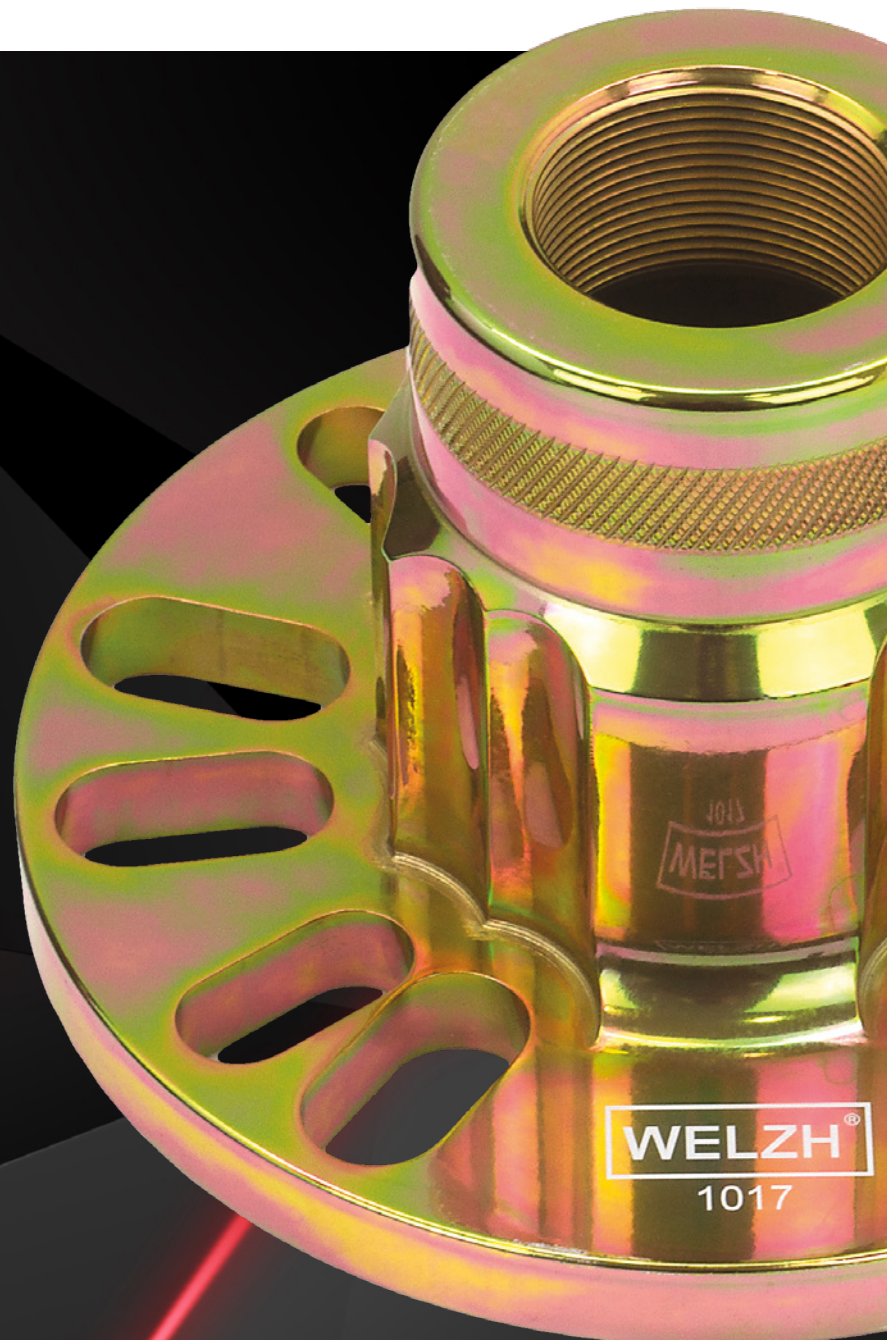

Bushing Tool Kit For VW Polo N9

Steering and Suspension > Bushes and Rubbers

For easy and safe removal and replacement of silent blocks on front axle wishbone.
No removal necessary, minimizing the workload.
Contains spindle, spindle extension, shoulder nut, spacer, spindle adaptor M10x1.25 made of S45C carbon steel.



Art. 1042-WW

Silent Block Tool for Renault Laguna II

Steering and Suspension > Bushes and Rubbers

Remove & install front mounting bushes in rear sub-frame.
Can be used in-situ, with no need to remove the sub-frame from the vehicle.



Art. 1097-WW

Silent Block Tool For Bmw

Steering and Suspension > Bushes and Rubbers

Suitable for installation and removal of rear ball joints and bushes in a variety of BMW models:
1 series E81-E87.
3 series E36-E46-E83-E90-E91-E92-E93.
5 series models E60-E61.
6 series E63-E64.
7 series E38-E65-E66-E67.
8 series E31.
Z4 series E85-E86.
Mini Cooper S R53.



Art. 11142-WW

Silent Block Tool for VAG; 18 pcs

Steering and Suspension > Bushes and Rubbers

For the replacement of bushes on wishbone / trailing arms, wheel bearing housing, lower wishbone downside / inside.
Allows renewing of bushes on the vehicle, when installing.
VW Golf 5 Plus / Variant / 4-Motion Year 2005-2012, Jetta / Syncro Year 2006-2012, Scirocco / 2009-2012, Beetle / Year 2012 -, Eos Year 2006-2012.



Art. 1135-WW

Bush Tool for Rear Axle on Ford Fiesta MK6 2008 onwards

Steering and Suspension > Bushes and Rubbers

For the installation and removal of the rear axle body mounting bush found on Fiesta Mark VI 2008 onwards.
Fiesta Bush Number: 1805815 (FEB34748).



Art. 7003-WW

Bush Kit for Vauxhall 2004-14; Rear Axle

Steering and Suspension > Bushes and Rubbers

For replacing the bushes whilst the swinging arm is still on the vehicle.
Applications: Astra 2004-2014, Meriva 2010 onwards and Zafira 2005-2012.



Art. 4092-WW

Trailing Arm Bush Tool Ford Mondeo MK4 & Galaxy S-Max

Steering and Suspension > Bushes and Rubbers

This kit can also be used with Art. 4148, 12 ton hydraulic ram.
Designed to be used in situ with vehicle offering the most efficient method of completing the task.
Make Model Applications.
Ford Galaxy (06-10) Remove/Install.
Ford Mondeo (07-13) Remove/Install.
Ford S Max (06-13) Remove/Install.
Volvo S60 Mk II (10-13) Remove/Install.
Volvo V70 Mk III (07-13) Remove/Install.

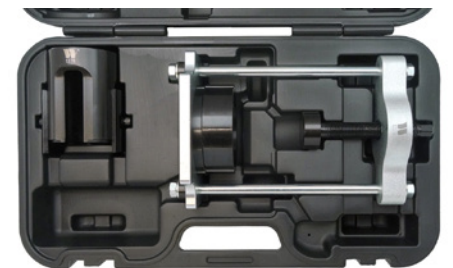

Art. 1178-WW

Bushing Kit for Mondeo and Galaxy S-Max

Steering and Suspension > Bushes and Rubbers

Ford & Volvo Rear Bush Kit for Mondeo, Galaxy, S-Max, S60, V70.
Pro Range On car solution for dismantling and installing the rear wishbone/ trailing arm bush
Ford Mondeo - 2007. Mondeo Estate - 2000 - 2007. S-Max - 2006. Galaxy - 2006. Volvo XC 70 - 2007.



Art. 4149-WW

Bush Kit for Rear Axle on Ford Focus

Steering and Suspension > Bushes and Rubbers

This kit can also be used with Art. 4148, 12 ton hydraulic ram.
 Designed to be used in situ with vehicle offering the most efficient method of completing the task.
 Make, Model, Applications:
 Ford Focus Mk I (98-07) Remove/Install.
 Ford Focus Mk II (98-07) Remove/Install.
 Ford Kuga (before 08) Remove/Install.
 Ford C Max MPV ((07) Remove/Install.
 Mazda 3 (Chassis BK 03-09) Remove/Install.
 Mazda 5 (Chassis CR, CW) Remove/Install.
 Volvo V50 Estate (04-12) Remove/Install.
 Volvo S40 Mk II (03-12) Remove/Install.



Art. 60048-WW

Ford Focus & Mazda 3 Trailing Arm Bush Removal / Installer Set

Steering and Suspension > Bushes and Rubbers

This kit can also be used with Art. 4148, 12 ton hydraulic ram.
 Designed to be used in situ with vehicle offering the most efficient method of completing the task.
 Make, Model, Applications:
 Ford Focus Mk I (98-07) Remove/Install.
 Ford Focus Mk II (98-07) Remove/Install.
 Ford Kuga (before 08) Remove/Install.
 Ford C Max MPV ((07) Remove/Install.
 Mazda 3 (Chassis BK 03-09) Remove/Install.
 Mazda 5 (Chassis CR, CW) Remove/Install.
 Volvo V50 Estate (04-12) Remove/Install.
 Volvo S40 Mk II (03-12) Remove/Install.

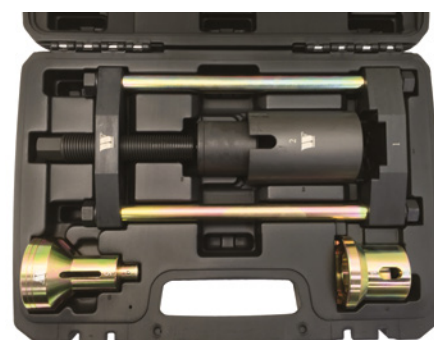

Art. 1181-WW

Bush Tool for Volkswagen Golf 5

Steering and Suspension > Bushes and Rubbers

Using pressure via the force screw the bushing can be pressed out of the housing with ease and installed via the same method.
 Make, Model, Applications:
 VW Golf V, VI (03), Plus (05) Remove/Install.
 VW Scirocco (08) Remove/Install.
 VW Eos (06) Remove/Install.
 VW Jetta III, IV (05) Remove/Install.
 VW Passat (05) Remove/Install.
 VW Sharan (10) Remove/Install.
 Audi A3 (03) Remove/Install.
 Audi TT (06) Remove/Install.
 Seat Altea (04) Remove/Install.
 Seat Leon (04) Remove/Install.
 Seat Toledo (04-09) Remove/Install.

Seat Alhambra (10) Remove/Install.
 Skoda Octavia (04) Remove/Install.
 Skoda Superb (08) Remove/Install.
 Skoda Yeti (09) Remove/Install.



Art. 4133-WW

Universal Press & Pull Sleeve Set

Hubs and Bearings > Universal Bearing Kits

This Universal tool is designed for removing and installation of silent bushings, hydraulic bushings, ball bearings, oil seals, rubber bushings, etc.
 The tool set is ideal for different vehicles such as car, SUV, van and can be used with spindle and hydraulic-workshop-press.
 20 Pressure Sleeves with control cut-out:
 Inside diameter: 34, 36, 38, 40, 42, 44, 46, 48, 50, 52, 54, 56, 58, 60, 62, 64, 66, 68, 70, 72 mm
 Outside diameter: 44, 46, 48, 50, 52, 54, 56, 58, 60, 62, 64, 66, 68, 70, 72, 74, 76, 78, 80, 82 mm
 M16 Ball Bearing Spindle.
 M14 Ball Bearing Spindle.
 M12 Ball Bearing Spindle.
 M10 Ball Bearing Spindle.



Art. 67305-WW

Universal Press & Pull Sleeve Set For Commercial Use

Hubs and Bearings > Universal Bearing Kits

Applications: Silent bushings, hydraulic bushings, ball bearings, oil seals, rubber bushings, etc.
 This kit is ideal for different commercial vehicles such as LGVS, HGVS, Tractors ect. and can be used with spindle and hydraulic-workshop-press.
 Sizing of cup inside: 74,76,78,80,82,84,86,88,90,92,94,96,98,100,102,104,106,108,110,112mm.
 Outside: 84,86,88,90,92,94,96,98,100,102,104,106,108,110,112,114,116,118,120,122mm.
 Sleeve sizes: Inner 74 to 112mm (2mm steps).
 Outer 84 to 122mm (2mm steps).
 Spindle Sizes: M10, 12, 14, 16, 18.
 Particularly useful for HGV due to the much larger sizes.
 Slotted sleeves allows an easy view of the bearing or bush etc.



Art. 4033-WW

Press And Pull Sleeve Set; 26 pcs

Steering and Suspension > Bushes and Rubbers

Comprehensive kit for fast and effective removal and installation of wheel bearings & suspension bushes.
 Reduces the possibility of damaging the bearing and housings.
 Supplied with four stepped end plates.
 4 screws: M10 x 1.5 - M12 x 1.5.



Art. 78093-WW

27-Piece Universal Press & Pull Sleeve Set

Hubs and Bearings > Universal Bearing Kits

This precision tool kit is for extracting and drawing in bushes, bearing, seals, etc.
 A widely applicable set suitable for a majority of cars, LGV and HGV. Can be used independently (manual operation) or with a suitably sized workshop press and can be reworked (eg. recess, etc) depending on requirements.



Art. 8020-WW

Replacement Spindle Set M10, M12, M14, M16

Hubs and Bearings > Universal Bearing Kits

Replacement Spindle set From 67305-WW.
 Supplied in EPA Foam Tray.
 Size: M10, M12, M14, M16.

Art. 67305-1-WW

Parts also available separately:

M10 Spindle For 67305 With Thrust Bolts	Art. 67305-M10-WW
M12 Spindle For 67305 With Thrust Bolts	Art. 67305-M12-WW
M14 Spindle For 67305 With Thrust Bolts	Art. 67305-M14-WW
M16 Spindle For 67305 With Thrust Bolts	Art. 67305-M16-WW
M18 Spindle For 67305 With Thrust Bolts	Art. 67305-M18-WW

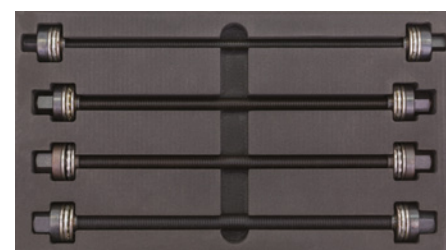

Universal Press Support Frame

Presses > Hydraulic Press

Included: 2 sets of legs, allowing for a wider range of applications.
 2 adapter rings for use with press and pull and ball joint kits.
 Can be used as a standalone kit but with added Welzh adapter kits more specialist applications can be completed.
 The benefit for any garage or workshop is the ability to have one frame and add the adapters you need.
 The 4148 hydraulic ram works extremely well with this kit, sold separately.
 Allan key for the interchangeable legs.
 Vibro-Spindle Included.



Art. 67306-WW

Adapter for Ford Focus and Mazda 3 Rear Bushes - Installation and Removal

Steering and Suspension > Bushes and Rubbers

This kit can also be used with Art. 4148, 12 ton hydraulic ram.
 Designed to be used in situ with vehicle offering the most efficient method of completing the task.

Make, Model, Applications:

Ford Focus Mk I (98-07) Remove/Install.
 Ford Focus Mk II (98-07) Remove/Install.
 Ford Kuga (before 08) Remove/Install.
 Ford C Max MPV ((07) Remove/Install.
 Mazda 3 (Chassis BK 03-09) Remove/Install.
 Mazda 5 (Chassis CR, CW) Remove/Install.
 Volvo V50 Estate (04-12) Remove/Install.
 Volvo S40 Mk II (03-12) Remove/Install.



Art. 1181-ADPT-1-WW

Adapters for 67306-WW For Mercedes Sprinter, VW Crafter

Steering and Suspension > Bushes and Rubbers

New set designed to be used with 67306-WW. Includes a new sleeve to accommodate after-market arms. For use when removing and installing ball joints on Mercedes Sprinter '95 -'06 and revised 2006 models.

Codes: (901, 902, 903, 904 and 906).

Applications: Mercedes-Benz Sprinter from 1995, VW Crafter from 2006, VW LT 1996 - 2006.



Art. 67306-A1-WW

Ford Transit Lower Arm Bush Tool For Use With 67306-WW

Steering and Suspension > Bushes and Rubbers

For the removal and replacement of the large rear bush on the lower arms of Ford Transits from 2000 – 2013.

Can also be used in a workshop press for lower arms when they have been removed from the vehicle.

Designed to be used with Welzh 67306-WW press frame and Hydraulic Ram 4148-WW.

On vehicle solution with minimal strip down.

Applications: Ford Transit Mk5 & Mk6 from 2000 to 2013.

OEM Bush Numbers covered: 4042024, 4372132, 4540787 & 737213.



Art. 67306-A2-WW

Wheel Hub Puller With Heavy Duty Sliding Hammer

Hubs and Bearings > Universal Bearing Kits

Allows the removal of wheel hubs.
Suitable for everyday workshop use.
Fits on 4- and 5-hole hubs with hole circle diameter of 98 to 125 mm.
4212-WW Heavy duty slide hammer included.



Art. 2113-WW

Hub Puller; 12 ton Hydraulic Ram

Hubs and Bearings > Universal Bearing Kits

12-ton hydraulic ram (4148-WW).
Especially for glued and rusty drive shafts.
Fits on 4- and 5-hole hubs with hole circle diameter of 98 to 125 mm.
For wheel bolt up to M14.
For SUVs and light trucks.
Spindle can be turned by hand or ratchet.



Art. 1017-WW

Hub Puller Base From 1017-WW

Hubs and Bearings > Universal Bearing Kits

Fits on 4- and 5-hole hubs with hole circle diameter of 98 to 125 mm.
For wheel bolt up to M14.



Art. 1017-2-WW

Hub Puller Tool; 12 ton Hydraulic, LGV

Hubs and Bearings > Universal Bearing Kits

This set comes complete with a 12 ton hydraulic ram suitable for any task you will come across.
Applications Citroen: Jump Dispatch, Jumper and Relay Ford: Transit Fiat: Ducato Iveco Daily 2,
Daily 3 LDV: Maxus Mercedes -Benz: Sprinter, Vito Vauxhall: Movano, Vivaro Peugeot: Boxer,
Expert Renault: Master, Trafic.
Can be used on hubs with 4, 5, and 6 holes.



Art. 1017-1-WW

Hub Puller with Hydraulic Ram and Slide Hammer; New Base Size

Hubs and Bearings > Universal Bearing Kits

Simplifies the disassemble since less power is needed.
Hydraulic Spindle can be operated either by hand or hand ratchet.
For 4 or 5 bolt wheel hubs.
Spindle pressure 12 Ton.
Supplied in an heavy duty Case.

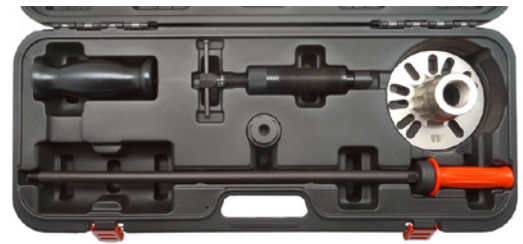

Art. 1131-WW

Hub Arbieter™

Hubs and Bearings > Universal Bearing Kits

For use on all new Generation 2 & 3 Hub-Bearing Units.
Allows the hub to be removed even when severely corroded.
Universal use on most wheel bearings allows disassembly and assembly of the wheel hub and the wheel bearings.
Includes pressure plates with diameters of: 50, 55, 59, 63.3, 66.6, 70.3, 71.5, 73.1, 73.4, 74.8, 77.5.
Simply Bolt to the wheel hub then power strike with a hammer allowing the hub to break free.
These new Generation Bearings are widely used on the most todays most popular cars: VAG, Landrover, Ford, Mazda, Volov, Kia etc (particularly Vauxhall/Opel Insignia rear wheels).



Art. 8024-WW

Compact Wheel Bearing Kit; 62, 66, 67, 72, 78, 82, 85 mm GEN2

Hubs and Bearings > GEN2 Bearings

The GEN 2 type of wheel bearing is predominantly fitted to models from Ford, Land Rover, Mazda, VW Group and Volvo. Includes a variety of different diameter tool kits covering a range of sizes to suit the different GEN2 bearings used by vehicle manufacturers. Designed to distribute pressing force evenly through the outer bearing race and also allows for the suspension leg to remain in-situ on the vehicle when fitting new bearings. GEN2 Bearing Removal Combination Tool Kit. 62 / 66 / 72 / 78 / 82 / 85mm. Combination Kit for Audi / Seat / Skoda / VW applications.

Consists of all necessary parts from the 62, 66, 72, 78, 82 & 85mm kits.
62mm Kit - Audi A2, VW Lupo (Front).
66mm Kit - Skoda Fabia, VW Fox (Front), Polo.
72mm Kit - Audi A1, Audi A2, Seat Cordoba, Ibiza, Skoda Fabia, Roomster, VW Polo (Front), VW Fox with PAS (Front).
78mm Kit - Ford Focus II, C-Max, Volvo C30, C70, S40, V50 (Front), Mazda 3.
82mm Kit - Ford Mondeo, Galaxy, S-Max, Land Rover Freelander 2, Volvo S80, V70, XC60, XC70.
85mm Kit - VW Multivan, Touareg, Transporter (Front / Rear).
Replacement spindle available: 10100-WW.

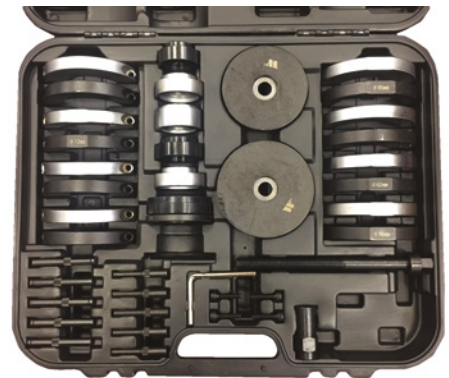

Art. 1033-1-WW

Compact Wheel Bearing Kit; 62, 66, 72, 85 (VAG Master Kit) GEN2

Hubs and Bearings > GEN2 Bearings

The GEN 2 type of wheel bearing is predominantly fitted to models from VW Group . Includes a variety of different diameter tool kits covering a range of sizes to suit the different GEN2 bearings used by vehicle manufacturers. Designed to distribute pressing force evenly through the outer bearing race and also allows for the suspension leg to remain in-situ on the vehicle when fitting new bearings. GEN2 Bearing Removal Combination Tool Kit. 62 / 66 / 72 / 85mm.

Combination Kit for Audi / Seat / Skoda / VW applications.
Consists of all necessary parts from the 62, 66, 72, 78, 82 & 85mm kits.
62mm Kit - Audi A2, VW Lupo (Front).
66mm Kit - Skoda Fabia, VW Fox (Front), Polo.
72mm Kit - Audi A1, Audi A2, Seat Cordoba, Ibiza, Skoda Fabia, Roomster, VW Polo (Front), VW Fox with PAS (Front).
85mm Kit - VW Multivan, Touareg, Transporter (Front / Rear).
Replacement spindle available: 10100-WW.

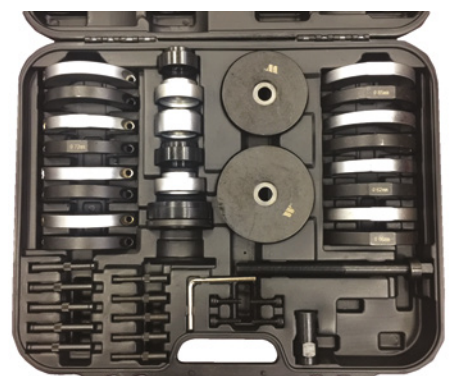

Art. 1033-WW

Compact Wheel Bearing Set 72mm GEN2

Hubs and Bearings > GEN2 Bearings

Facilitates assembly and disassembly of wheel hub-bearing unit.
Suitable for Audi A2 and Skoda Fabia 00-, VW Polo and Seat Ibiza 02-, VW Fox 05-.
High-strength ball bearing fitted spindle.
Replacement spindle available: 10100-WW.



Art. 1039-WW

Compact Wheel Bearing Kit; 85 mm GEN2

Hubs and Bearings > GEN2 Bearings

Facilitates assembly and disassembly of wheel hub-bearing unit.
Suitable for VW T5 and Touareg with 16" rims.
High-strength ball bearing fitted spindle.
Pressure plate with 8 holes.
5 bolts.
1 pair of divided dismantling shells.
Replacement spindle available: 10100-WW.



Art. 1132-WW

Compact Wheel Bearing Kit; 78 mm GEN2

Hubs and Bearings > GEN2 Bearings

Facilitates assembly and disassembly of front wheel hub-bearing unit.
Suitable for following models:
Ford Focus 2 as of 2004, C-Max as of 2003.
Volvo C30 as of 2006, C70 Cabriolet as of 2006.
S40 as of 2004, V50 as of 2004, Mazda.
Replacement spindle available: 10100-WW.



Art. 1144-WW

Compact Wheel Bearing Kit; 82 mm GEN2

Hubs and Bearings > GEN2 Bearings

Facilitates assembly and disassembly of front wheel hubs.
For use with workshop hydraulic press.
Applications: Ford Focus, Focus II.5RS/ Focus 2.5RS 50, Galaxy, S-max, Volvo S80, V70, XC60, XC70, Land Rover.
Replacement spindle available: 10100-WW.



Art. 1145-WW

Compact Wheel Bearing Kit; 90 mm GEN2

Hubs and Bearings > GEN2 Bearings

Facilitates assembly and disassembly of front wheel hubs.

For use with workshop hydraulic press.

Suitable for Audi models:

A4 / S4 Quattro Avant 2001-2008.

A6 / S6 Quattro Avant 2002-2005.

A8 / S8 Quattro Avant 2004-2007.

R8 since 2007.

Replacement spindle available: 10100-WW.



Art. 1146-WW

Compact Wheel Bearing Kit; 62, 66, 72 mm GEN2

Hubs and Bearings > GEN2 Bearings

Suitable for following VAG models:

Audi A2.

VW Lupo - Polo - Fox.

Seat Ibiza.

Skoda Fabia.

Fits on 62, 66 and 72 mm bearing unit.

Works direct on the vehicle.

Minimizes the working time.

Simple and safe handling.



Art. 80002-UTC

Brake Disk Removal Tool For Ford Transit

Hubs and Bearings > GEN2 Bearings

Suitable for removal and installation of brake discs on front and rear wheel drive vehicle.

To be used as OEM 204-345B



Art. 4109-WW

Compact Wheel Bearing Kit; Ford Transit, GEN2

Hubs and Bearings > GEN2 Bearings

Combines the 4110-WW and 1133-WW.

Ford Transit front disc and bearing removal from 2000 onwards.

Inner bearing ring extracted without the need for grinding.

An on vehicle solution that allows the drive flange to be re-used.

Must have item.



Art. 60030-WW

Bearing Removal Tool for Ford Transit Custom Front Hubs

Hubs and Bearings > GEN3 Bearings

Front Bearing Tool For Ford Transit Custom Vans 2012- Onwards.
For the GEN 3 Bearing on Transit Custom which have a built in drive flange.
Enables the damage free removal of the front Wheel- bearing / Brake Disc assembly.
With disc/bearing assembly removed the tool can be used to separate the disc and bearing.
Replacement Spindle 4086-1-WW



Art. 4086-WW

Bearing Install and Removal Tool Kit; Universal, 23pcs

Hubs and Bearings > Universal Bearing Kits

Reduce the chance of damage to hub and bearing.
Suitable for removing and installing large industrial bearing.
Drift Sizes \varnothing : 55, 59, 63, 66.5, 70, 71.5, 73, 73.5, 75, 77.5, 81.5, 83.5, 88.5 mm.
Sleeve \varnothing External: 76, 86, 92, 101 mm.
Hub screw length: 210mm.
Hub screw drive: 32, 38mm.



Art. 800061-UTC

Bearing Tool Kit; Universal, 31pcs

Hubs and Bearings > Universal Bearing Kits

Universal use on most wheel bearings allows disassembly and assembly of the wheel hub and the wheel bearings.
Includes pressure plates with diameters of:
50 - 55 - 59 - 63.3 - 66.6 - 70.3 - 71.5 - 73.1 - 73.4 - 74.8 - 77.5 mm.



Art. 4049-WW

52-Piece Mounting Press Set

Hubs and Bearings > Universal Bearing Kits

Suitable for mounting of bearings, sealing rings and rubbers.
Works well with WELZH 1070-WW.
This kit includes mounting pads in following sizes:
18 to 65 mm (1 mm steps) and 74 mm.
12 mm \varnothing bore.
180 mm metal handle for use with hammer.



Art. 1013-1-WW

Bearing Mounting Press Set; 52pcs

Hubs and Bearings > Universal Bearing Kits

Suitable for mounting of bearings, sealing rings and rubbers.
Works well with WELZH 1070-WW.
This kit includes mounting pads in following sizes:
18 to 65 mm (1 mm steps) and 74 mm.
12 mm Ø bore.
180 mm metal handle for use with hammer.



Art. 800064-UTC

64-Piece Mounting Press Including Vibration Adaptor

Hubs and Bearings > Universal Bearing Kits

Suitable for mounting of bearings, sealing rings and rubbers.
Works well with WELZH 1070-WW.
Includes:
12mm X 55mm DISC CONNECTOR.
12mm X 45mm DISC CONNECTOR.
12mm X 180mm HANDLE.
19mm X 273mm HANDLE.
1PC L WRENCH.
58 Discs: 18, 19, 20, 21, 22, 23, 24, 25, 26, 27, 28, 29, 30, 31, 32, 33, 34, 35, 36, 37, 38, 39, 40, 41, 42, 43, 44, 45, 46, 47, 48, 49, 50, 51, 52, 53, 54, 55, 56, 57, 58, 59, 60, 61, 62, 63, 64, 65, 70, 74, 75, 80, 85, 90, 95, 100, 105, 110 mm.
1 Vibration Adaptor (#1070-6).
O-Ring Replacements with Case (10PCS)



Art. 1013-2-WW

21-Piece Extra Large Mounting Press Set

Hubs and Bearings > Universal Bearing Kits

Suitable for mounting bearings and sealing rings.
Particularly useful when used with a hydraulic press.
This kit includes 17 mounting pads.
Ø 70 to 150 mm (5 mm steps).
273 mm metal handle for use with a hammer.
Material: carbon steel.



Art. 1198-WW

Bearing Separator Kit; 14-Piece

Hubs and Bearings > Universal Bearing Kits

Includes shifter.
2 splitting knives: 30-50 mm and 50-75 mm.
For removing bearings, internal rings and.
Other tightly and narrowly mounted parts.



Art. 1256-WW

Bearing Separator Kit; 5pcs, 6.35 to 228.6 mm

Hubs and Bearings > Universal Bearing Kits

The Welch bearing separator kit contains the most popular sizes needed for the automotive and workshop sector, also included is a pulley pulling attachment.

Parts Included:

- Pulley pulling attachment with a 127mm max spread & 25.4mm min spread.
- Bearing separates 23.8mm max spread & 6.35mm min spread.
- Bearing separates 50.8mm max spread & 3.175mm min spread.
- Bearing separates 101.6mm max spread & 12.7mm min spread.
- Bearing separates 228.6mm max spread & 25.4mm min spread.



Art. 1250-WW

Hubs and Bearings > Universal Bearing Kits

Bearing Separators:

Bearing Separator 10-30 MM

Art. 1250-WW

Bearing Separator 30-50 MM

Art. 1251-WW

Bearing Separator 50-75 MM

Art. 1252-WW

Bearing Separator 75-105 MM

Art. 1253-WW

Bearing Separator 105-150 MM

Art. 1254-WW

Bearing Separator 150-200 mm

Art. 1255-WW



Universal Ring Puller GOLD-EDITION

Hubs and Bearings > Universal Bearing Kits

Three jaws with the thin edge provide an equal grip tension to avoid any slide or tilt. Prevents unnecessary Grinding.

Suitable for all kind of bearing and sleeves diameter up to 125mm.

Applicable: Renault, Peugeot & Citroen Toyota, Benz, BMW, Nissan, Honda, Mazda, Lexus, etc.

Replacement legs 1168-1-REPAIR-WW.



Art. 1168-WW



Bearing Race and Seal Driver; Universal, Adjustable

Hubs and Bearings > Universal Bearing Kits

Durable and tough aluminium construction with rubberised striking tip.



Art. 4203-WW

Bearing Puller for Blind Hole Bearings; 16pcs

Hubs and Bearings > Universal Bearing Kits

For dismantling of bearings installed in a blind hole.
Is used when repairing e.g. car transmissions.
Includes the following tools:
Slide hammer, length 290 mm.
2-feet puller with spindle.
Expansion sleeves for bearing with an inner Diameter 5 - 52 mm.



Art. 78910-WW

Bearing Puller for Blind Hole Bearings; 5pcs

Hubs and Bearings > Universal Bearing Kits

Suitable for extracting bearings, bushings, sleeves, etc.
Especially for removing out blind holes.
Includes:
370 mm slide hammer, 1430 g.
4 spreading claws: 10-14, 15-19, 18-25 and 25-32 mm.



Art. 800041-UTC

Puller Set; 10 ton Hydraulic

Pullers and Installers > Hydraulic Pullers

Hydraulic ram 10 ton (4148-WW).
2 extension rods one twin head and one triple head.
3 legs each in following lengths: 100, 150 and 200 mm.
Max. pulling width: 240 mm with 100 mm pulling leg length.
280 mm with 150 mm pulling leg length.



Art. 4102-WW

Puller Set 2 & 3 Legged; 12-Piece Universal

Pulling Equipment > Manual Pullers

Puller legs are suitable for 2- and 3-leg crossbars (included).
Free moving legs allow internal and external pulling operations.
Pulling depth up to approx. 105 - 210 - 265 mm.
Pulling width up to max. 135 mm.
Hardened pulling feet.



Art. 4117-WW

16-Piece Slide Hammer Puller Set

Pulling Equipment > Manual Pullers

Can be used as internal or external extractor with 2 or 3-claws, for disassembly of 4 and 5-hole wheel hubs and as pulling or impact hammer for body repair.

Material: forged chrome vanadium steel.

Includes following tools:

- 1 puller yoke with 2 extension arms.
- 1 puller yoke with 3 extension arms.
- 2.3 kg sliding hammer.
- 2 wheel hub adapters.
- 1 self grip pliers adapter.
- 1 dent adapter.
- 3 puller feet.



Art. 800037-UTC

G-Hook

Pulling Equipment > Manual Pullers

For pulling out of ball joints from the wheel bearing housing, straightening work on car bodies.

The open design will allow this item to be use on a huge amount of applications.

Paired with the 4212 you will have unstoppable pulling force.



Art. 4201-WW

Heavy Duty Slide Hammer **For Use with WELZH Adaptor Kits**

Pulling Equipment > Manual Pullers

Heavy duty slide hammer compatible with a large number of Welzh products look out for the symbol for compatibility.

M18 x 1.5 thread allows use throughout the Welzh range of tools giving a high amount of applications.

Huge 2.5kg hammer.



Art. 4212-WW

Adaptor To connect 1017-ww & 1017-1-WW

Adapter to allow 4212 and 1017 to be used with a slide hammer.

Also suitable for use with 1017-1-WW.

Art. 4212-1-WW

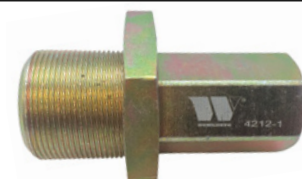

Clutch Alignment Tool

Powertrain > Clutch

Ideal for centring the clutch disk in cars without a clutch pilot bearing.

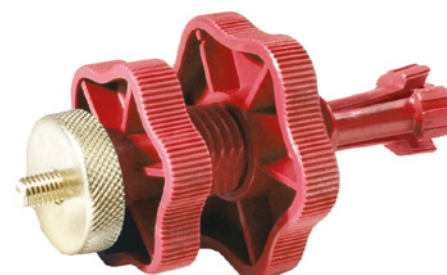

Art. 2522-WW

VW/AUDI DSG Clutch Tool Kit

Powertrain > Clutch

For use on VW Golf 2004 onwards, Tourareg (6 speed), Audi A3 2004 onwards
Designed for the installation & removal of twin clutches found on Audi & VW 6 & 7 speed gearboxes



Art. 5023-WW

Self Adjusting Clutch Tool Kit

Powertrain > Clutch

Designed to assembly and disassemble SAC Clutches.
Fits on nearly all SAC clutches with 3 and 4 hole pitch from VAG, MB, Opel, Volvo, Renault etc.
Applications: Audi A3, A4, A6, A8 VW Passat, Golf, Sharan, Tiguan Ford Mondeo, S-Max, Galaxy, Transit Mercedes C, E, CLS, S, CLK, SLK, SL BMW 320, 330, 520, 530 Alfa Romeo 147, 159, 166 Fiat Ulysse, Croma, Ducato Lancia Phedra, Thesis.



Art. 1035-1-WW

SAC Clutch Repair & Alignment Tool

Powertrain > Clutch

For fast and professional inputs and expansion of SAC clutches.
Suitable for a vast majority of SAC clutches with 3- and 4-hole pitch of the manufacturer VAG, MB, Opel, Volvo, Renault, etc.
Other models suitable for: Audi A3 A4, A6, A8, VW Passat, Golf, Sharan, Tiguan, Ford Mondeo, S-Max, Galaxy, transit, Mercedes C, e, CLS, S, CLK, SLK, SL BMW 320, 330, 520, 530, Alfa Romeo 147, 159, 166, Fiat Ulysse, Croma, Ducato, Lancia Phedra, Thesis.



Art. 1035-2-WW

Clutch Alignment Tool For Trucks

Powertrain > Clutch

Applications:
This tool set allows for the correct alignment of single or double disc clutches of trucks and tractors to the engine.
For trucks with single or double disc clutches (universal).



Art. 60038-WW

Dual Mass Fly Wheel Tool

Powertrain > Clutch

For testing the condition of the vehicles Dual Mass Flywheel (DMF).
Ideal for checking the DMF's condition before the new clutch is fitted.



Art. 7026-WW

Rack End Removal and Install Kit, 28-35 mm

Steering and Suspension > Universal Steering and Suspension

For fast and professional changing of the axle joints of cars and light commercial vehicles.
Automatic clamping of the joint heads and easy assembly of long tie rods because of open construction.
Saves up to 3 hours of working time.
For joint heads \varnothing 28 - 35 mm.
Works with 1/2" ratchets or 27 mm sockets.



Art. 4051-WW

Axle Joint Tool 35-45 MM

Steering and Suspension > Universal Steering and Suspension

For fast and professional changing of the axle joints of cars and light commercial vehicles.
Automatic clamping of the joint heads and easy assembly of long tie rods because of open construction.
Saves up to 3 hours of working time.
For joint heads \varnothing 35 - 45 mm.
Works with 1/2" ratchets or 27 mm sockets.



Art. 1003-WW

Steering Wrack End Remover Tool 22-55 mm

Steering and Suspension > Universal Steering and Suspension

For fast and professional changing of the axial joints of cars and light commercial vehicles.
Automatic clamping of the joint heads.
Can be used without removing the rack and pinion.
Saves up to 3 hours of working time for joint heads \varnothing 22 - 55 mm.
Works with 1/2" ratchets.



Art. 1003-1-WW

Tie Rod Remover; Inner, 27-42 mm

Steering and Suspension > Universal Steering and Suspension

For removing the inner tie rod without dismantling the rack and pinion.
Universal applications with a range of 27 to 42 mm.
Should be used with a 1/2 drive ratchet.



Art. 30896-WW

Rack End Removal and Install Kit, Universal

Steering and Suspension > Universal Steering and Suspension

Designed for the fast and professional changing of the axial joint.
Can be used on cars and light commercial vehicles.
Automatic clamping of joint heads.
Can be used on 30 - 45 mm joint heads.
3 exchangeable heads in one kit.
Head sizes: (30-35) (35-40) (40-45).
Works with a 1/2" ratchet.



Art. 8116-WW

Rack End Removal Tool for HGV's

Steering and Suspension > Universal Steering and Suspension

Specially designed to remove track rod ends found on HGVs.
Particularly useful when the taper is separated.
Can be used with an impact wrench and 36 mm socket.
Simple solution to an awkward problem.
Because of the scale of the track rod and the build up of dirt the task can prove tricky. This simple solution allows you to use pneumatic tools to aid in the removal of the track rod saving time and unwanted effort. Must have!!!

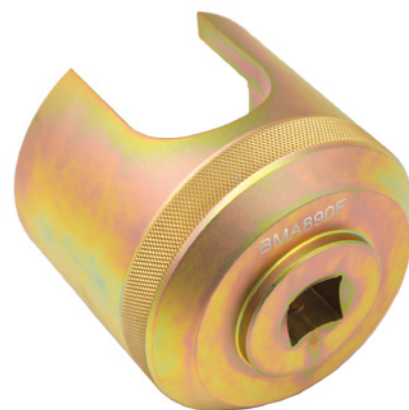

Art. 4091-WW

Shock Absorber Tool Kit

Steering and Suspension > Universal Steering and Suspension

Fits most popular vehicle types.
For repair jobs on shock absorbers and for retaining the shock absorber piston.
Includes:
Ratchet, reversible.
Allen inserts: length 122 mm, 16 - 17 - 18 - 19 - 21 - 22 - 24 mm.
Hexagon socket inserts, length 122 mm, 6 - 7 - 8 mm.
Special inserts, (oval), length 122 mm, 5x8 - 6x8 - 7,1x9,6 mm.
Porsche Cayenne S, VW Touareg, 6-hexagon inserts, length 122 mm.
7 mm for Mercedes Benz Vaneo, 8 mm for BMW, 9 mm for Opel.
Corsa B, Astra F / G, Vectra B, T50, length 122 mm for Opel Astra H.



Art. 8019-WW

Universal Pulley Puller

Specialist Sockets > Other Specialist Sockets

Draws pulley by the holes without causing damage.
Adjustable legs allow the puller to adapt to many applications.
Can be used on many variations• 8 slots for holding pulling legs in different positions• 18 mm pulling legs• Ø 16 mm spindle with centring ball 24 mm drive



Art. 1016-WW

Strut Mate™

Steering and Suspension > Universal Steering and Suspension

Provides a highly efficient solution for supporting and holding the strut in place while working on the vehicle.
To be used in conjunction with a transmission jack.



MADE IN GREAT BRITAIN

Art. 3400-WW

Wheel Separator for Dual Wheels

Steering and Suspension > Universal Steering and Suspension

Designed to remove dual steel wheels which have become seized together over time.
The special design of the tool clamps on to the outer rim of each wheel.
Can be used with pneumatic tools making the task much easier.
Huge time saver.
Suitable for use on a wide range of vehicles e.g. HGV's, buses, trailers, vans, motor-homes etc.



Art. 4094-WW

Puller For Ribbed Drive Belt Pulleys

Steering and Suspension > Universal Steering and Suspension

Pulling range 40 - 168 mm
For alternators, air conditioners, water pumps
Includes 10 mm hex wrench



Art. 1013-WW
WWW.WELZH.COM

Clamp For Strut Insert Pistons

Steering and Suspension > Universal Steering and Suspension

Universal clamping tool prevents the piston rod from fully retracting.

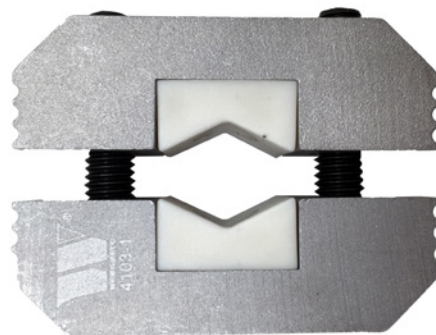

Art. 4103-1-WW

Clamp for Strut Insert Pistons - 60mm

Steering and Suspension > Universal Steering and Suspension

Universal clamping tool prevents the piston rod from fully retracting.

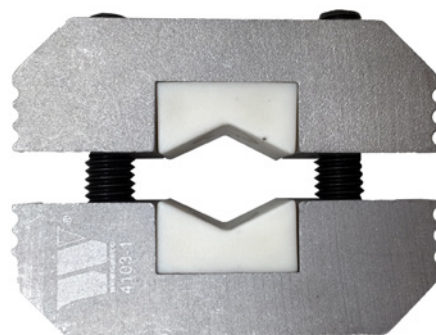

Art. 4103-2-WW

5-Piece Strut Nut Tool Set - Audi, VW, Mercedes

Steering and Suspension > Universal Steering and Suspension

Designed to hold the damper shaft during the re-fitting and removal of the strut nuts.

22mm Hexagon Drive.

Fits 22mm Spanner.

Includes:

VW / Audi: 10.5, 12.5, 14.5, 14.5.

Mercedes: W203 / W209 - 14.0.



Art. 7011-WW

Steering Wheel Level

Steering and Suspension > Universal Steering and Suspension

A must-have for quick and precisely even steering wheel assembly.

Avoid reassembly of leant steering wheels that are only recognized after test drive.

Much more accurate than the mechanics' eyes alone.



Art. 7018-WW

Coil Spring Compressor (Wishbone Version)

Universal spring compressor for wishbone/multi-link suspension with angled jaws.
Makes it easier, safer and more convenient to position the tool correctly inside the spring.
Prevents overload and improves safety.
Handles 95% of all cars with wishbone/multi-link suspension rear e.g. VW Touran, Citroen C3, Skoda Octavia, Peugeot 107 and many more.

Art. 1114-WW

Steering and Suspension > Spring Compressors



Mercedes Spring Compressor

Time saving design allows the user to remove/replace the coil spring on wishbone suspensions with dismantling the axle. For use on Multi-link independent suspensions found on FIAT, HYUNDAI, MAZDA, MERCEDES-BENZ, MITSUBISHI, NISSAN, PEUGEOT, ROVER, SAAB, TOYOTA, VOLVO, VW.

Art. 800038-UTC

Steering and Suspension > Spring Compressors



Inter Link Coil Spring Compressor

Universal spring compressor for wishbone/multi-link suspension with angled jaws.
Makes it easier, safer and more convenient to position the tool correctly inside the spring.
Prevents overload and improves safety.
Handles 95% of all cars with wishbone/multi-link suspension rear example VW Touran, Citroen C3, Skoda Octavia, Peugeot 107.

Art. 810008-UTC

Steering and Suspension > Spring Compressors



7pc Heavy Duty Coilspring Compressor

Can be used with air tools.
To be used on McPherson struts with cylindrical and conical springs.
Contains:
1 x telescopic spindle.
3 x chuck couplers.
1 x spacer for conical springs.
6 x plastic spring protectors.
Applications:
Audi, Alfa Romeo, BMW, Chrysler, Citroen, Ford, Fiat, Honda, Hyundai, Kia, Land Rover, Mazda, Mitsubishi, Nissan, Opel, Peugeot, Porsche, Renault, Saab, Seat, Subaru, Suzuki, Toyota, Vauxhall, VW and Volvo.

Art. 1006-WW

Steering and Suspension > Spring Compressors



Coilspring Compressor; Floor Standing, 1500 kg

Capacity: 1500kg.
Foot operated hydraulic unit with safety chain.
More efficient and quicker than ratchet style compressors.
Yokes are coated in a rubberised plastic to prevent damage and slippage.
Suitable for spring with a diameter of 80 to 175mm.
Complete with two sets of yokes.
Available separately:
819-1-WW: Replacement Hydraulic Ram.

Steering and Suspension > Spring Compressors



Art. 819-WW

Flexi Jaw Coilspring Compressor

Save time by easily compressing the coil spring without the need to dismantle the axle.
Flexi jaw fits a wide range of applications.

Steering and Suspension > Spring Compressors



Art. 1052-WW

C-Clamp With Vibro Spindle

To be used especially with 67305-ww pulling and pressing sleeve set with M18 spindle for impact use can be used with hydraulic ram 4148-ww
Distance from spindle to frame: 80mm
Max. pressing width: 220mm
Frame size: 340 x 185mm

Steering and Suspension > Ball Joint Kits



Art. 1037-WW

G-Clamp

Designed for facilitate the the pressing of bushings and bearings.
Can be used with the 4148-WW hydraulic ram.
Max. pressing width: 220 mm
Frame size: 340 x 185 mm
Distance from frame to spindle: 80 mm

Steering and Suspension > Ball Joint Kits



Art. 800046-UTC

5-Piece Manual Impact Driver

Steering and Suspension > Ball Joint Kits

Long life quality
Incl. 2 cross slot (PH2 - PH3) and 2 slot SL bits (8 - 10 mm)



Art. 60047-WW

Ball Joint Splitters; 3pcs

Art. 1020-WW

Steering and Suspension > Ball Joint Kits

For shifting/pushing the ball joint out of axle legs, drop arms, stabiliser.
Especially for working in narrow spaces.
Suitable only for working on closed joints or joints with centre hole.
Sizes: 23x55, 28x55, 34x63 mm.

Parts also available separately:

Ball Joint Splitter; 23x55 mm

Art. 1020-23-WW

Ball Joint Splitter; 28x55 mm

Art. 1020-28-WW

Ball Joint Splitter; 34x63 mm

Art. 1020-34-WW



3-Piece Ball Joint Separators

Steering and Suspension > Ball Joint Kits

For shifting/pushing the ball joint out of axle legs, drop arms, stabiliser.
Especially for working in narrow spaces.
Suitable only for working on closed joints or joints with centre hole.
Sizes: 23x55, 28x55, 34x63 mm.

Art. 800013-UTC

Balljoint Splitter 8 Ton Hydraulic

Steering and Suspension > Ball Joint Kits

Heavy duty design made to work every time. The benefit of using a hydraulic ram rather than a hammer or other form of impact is the gradual increase in pressure.

Jaw opening: 55 mm.
Jaw width: 22 mm.
Jaw depth: 30 mm.
Spindle capacity: 8 ton.
Working pressure: 40nm.



Art. 1108-WW

WWW.WELZH.COM



Ball Joint Separator 2-Stage

Steering and Suspension > Ball Joint Kits

This extra heavy duty ball joint separator is designed to split the most stubborn joint taper with ease.
Spindles maximum torque pressure 40nm.
Jaw opening 56mm.
Jaw width 22mm.
Jaw depth 30mm.



Art. 60046-WW

Vibration Impact Ball Joint Puller 39mm

Steering and Suspension > Ball Joint Kits

Suitable for cars, light trucks and SUV.
39 mm opening.
80 mm opening at housing.
90 mm max. pressure range.
Solid execution for long product life time.
Hardened pressure spindle and centering tip.



Art. 4048-WW

Hydraulic Ball Joint Splitter 12-Ton

Steering and Suspension > Ball Joint Kits

Designed to separate ball joints with the use of a hydraulic spindle.
Jaw opening: 56 mm.
Jaw width: 22 mm.
Max torque pressure: 40 nm.
12-ton hydraulic spindle.



Art. 800066-UTC

Ball Joint Kit; T4, T5, LT

Steering and Suspension > Ball Joint Kits

For assembly and disassembly of the upper supporting joints on VW T4, T5 & LT.
1 Extractor with hardened spindle (24mm hex drive).
2 Extension plates to adapt the extractor to the joint.
3 Interchangeable pressure pieces.



Art. 1012-WW

Ball Joint Remover and Installer for Volvo

Steering and Suspension > Ball Joint Kits

Designed to be used on the lower control arm ball joint.

Slide hammer puller adapters:

M12 x 1.75.

M14 x 1.5.

M14 x 2.0.

5/8" x 18.

Make Model Year.

Volvo S60 2001-2009.

Volvo S80 1999-2006.

Volvo V70 2001-2007.

Volvo XC70 2003-2007.

Volvo XC90 2003-2014.



Art. 4196-WW

Ball Joint Assembly Set; 21-Piece

Steering and Suspension > Ball Joint Kits

Heavy duty model with 152 mm pressure fork opening the set includes all necessary bushes and pressure plates for changing the ball joints on most US, European SUV cars and Transporter.

230 mm pressure spindle.

Pressure spindle arm.



Art. 51003-WW

Balljoint / Tie Rod Separator Set 5-Piece

Steering and Suspension > Ball Joint Kits

Jaw opening approx. 17.4 - 23.8 - 28.5 mm.

Manufactured from forged carbon steel.

2 exchangeable handles - 1 for manual use and 1 for air hammer use/adaptor.



Art. 800078-UTC

Ball joint Separator Kit; 5-Piece

Steering and Suspension > Ball Joint Kits

For separation of ball joints.

Includes 5 separator forks fork opening: 20, 24, 30, 35, 42 mm.

Shaft diameter: 10 mm.

Length: 180 mm.



Art. 5020-WW

Vibration Impact Ball Joint Separators 20-42mm

Steering and Suspension > Ball Joint Kits

Designed to aid the removal of Seized Ball Joint.
To be used with WELZH 1070-10-WW Vibration Hammer.
5 fork separators with fork openings: 20mm, 24mm, 30mm, 35mm, 42 mm.
Shaft diameter: 10 mm.



Art. 4047-WW

CV Joint Puller

Steering and Suspension > CV Joints

This tool allows removal of CV joints without removing the driveshaft saving huge amounts of time.

Fully adjustable design allows use on most common vehicles on the market.

Internal width 99 mm.

Internal length 204 mm.

Unique design.



Art. 4050-WW

Air Installation Tool For CV Boots

Steering and Suspension > CV Joints

For the installation of CV boots without removing the drive shaft.

Save huge amounts of time compared to traditional methods.

Specification Value.

Joint Diameter 110 mm.

Weight 2kg.

Max Air Pressure 116psi.

Air Inlet 1/4" BSP.



Art. 4192-WW

Tie Rod Spanner 4-Link Suspension On VAG Models

Steering and Suspension > Specialist Spanner Sets

For adjusting the toe-in quickly & precisely.

This tool prevents the rubber connection from damage with its special bridged design.

Cost and time effective.

Application: Audi A4 from '94, A6 from '00, A8 from '02, Seat Exeo from '10.

Can also be used on many other VAG Group vehicles.

The only tool that will fit perfectly to the tie-rod.



Art. 4194-WW

Hub Mate Supporting Adaptor Device

Jacking and Lifting > Transmission Jack Accessories

Designed for supporting Control Arm, Universal application.
The HUB MATE SUPPORTING ADAPTOR is used in conjunction with a transmission jack.
The support takes place via the wheel hub ensuring the correct raising and lowering of control arms/axles to specified positions. Very effective when applied to removal and installation of suspension struts.



Art. 3200-WW

Wishbone Off-Set Lever Bar Pat*

Steering and Suspension > Drop Arm Pullers

Principle of operation:

The design of this tool allows you to push down on the wishbone and other suspension parts during the disassembly of the drive shaft when replacing the wheel bearing. In the majority of cases the wishbone must be pressed down onto the bush in order to pull the joint from the support. When using traditional methods the ball joint is prone to damage. A safe working environment can be achieved when using this tool compared to traditional methods.



Art. 1128-WW

Wishbone Lever; Universal

Steering and Suspension > Drop Arm Pullers

This tool is used to pull the lower suspension arms down and into place while the hub is being removed, making the job easier and more time effective.

Replace swivel joints, remove axle shafts and pull shock absorbers from the lower seat.

Pull down cross-linkers with ease, in order to access axles.

Easy to use an universal application thanks to adjustable chain length.

Allows totally hands free working environment when working on ball joints, wishbones etc. Usually this would require two people adding to expense and overall time.



Art. 7010-WW

Watch Online!



UNIVERSAL WISHBONE LEVER

SAVE TIME & MONEY: VIDEO ONLINE >>

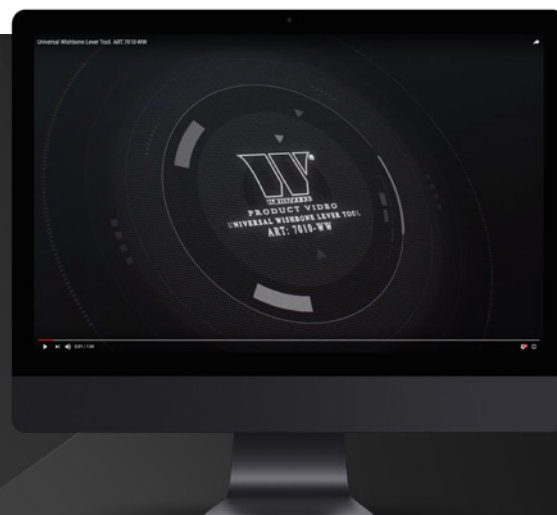

TIMING TOOLS



Camshaft Holders; Universal

Engine Tools > Universal Timing Tools

This cam gear holder's universal design is quick and easy to install.
Excellent for diesel injection pump belt replacement.
Clamp between the engine block or head & the back of the gear to lock in place.
Use on single, dual or quad cam engines to hold valve timing during belt replacement.
4-Piece set.



Art. 7025-WW

Fiat/Alfa Master Timing Tool Set

Engine Timing Tools > Universal Timing Tools

Flywheel - crankshaft
Adjusting crankshaft
Adjusting camshaft
Fuel injection pump shaft
Pulling off the crankshaft pulley
Tensioning of the timing belt
To be used as oem 1 860 847 000, 1 860 875 000, 1 870 697 000, 1 860 895 000, 1 895 879 000, 1 860 898 000, 1 860 992 000, 1 860 992 000, 1 863 000 (8mm), 1 860 771 000, 1 860 161 000, 1 860 874 000, 1 860 874 000, 1 860 876 000, 1 860 845 000, 1 860 876 000, 1 860 965 000, 1 860 901 000, 1 860 905 010, 1 860 987 000, 1 860 985 000



Art. 1074-WW

Timing Pulley Puller

Engine Tools > Universal Timing Tools

Can be used on pulley with 3, 6, 9 slots.
Especially useful for drive pulley with face grooves.
This tool saves the risk of damage to the pulleys during removal.
Legs are universally adjustable allowing it adapt to the many different pulleys available.



Art. 4062-WW

Universal Stretch Belt Tool

Engine Timing Tools > Universal Timing Tools

Universal tool set ideal for fitting stretch belts on a wide range of vehicles.



Art. 60040-WW

V-Ribbed Belt Mounting Tool Set

Engine Timing Tools > Universal Timing Tools

Allows free mounting of flexible multi-ribbed belts.
The flexible drive means no idler is required.
Suitable for various vehicles with multi-ribbed belts.
Applications: BMW & VAG Group.

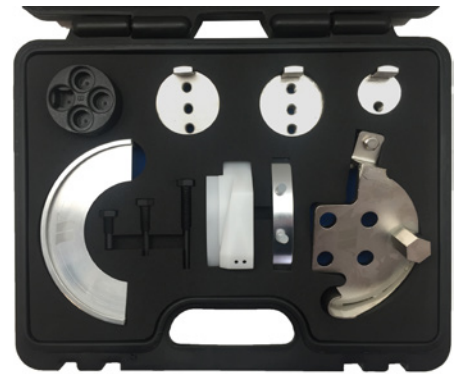

Art. 4009-WW

13-Piece Diesel Pump Timing Set

Engine Timing Tools > Universal Timing Tools

A measurement tool designed for resetting the timing position for diesel engines with the fuel pump.



Art. 51005-WW

Spanners for Poly-V-Belts

Spanner Sets > Specialist Spanner Sets

45 degree offset ends to reach awkward areas in the engine bay.
Sizes: 13, 15, 16, 17, 19 mm (460 mm long).
For use on the idler belt.
12 pt profiles.



Art. 1060-WW

Fuel Tank Sender Unit Spanner Set

Spanner Sets > Specialist Spanner Sets

For assembly and disassembly of the plastic retaining rings of the fuel tank sender unit.
5 different shaped pairs of clamping arms allow use on a variety of fuel tanks.
Can be used for diameters of 75-160mm, 80-122mm and 110-170mm.
Can be used with 2 and 3 arms.
24 mm hexagon drive.

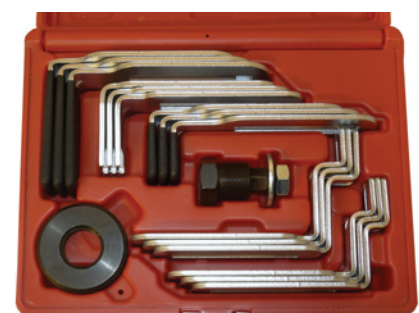

Art. 1065-WW

Engine Timing Tool Kit for VAG 1.0 / 1.2 / 1.4 L

Engine Timing Tools > Volkswagen Timing Tools

To test and adjust the engine timing.
For 1.0L 3 cylinder gasoline engines.
VW, SEAT, SKODA.



Art. 7089-WW

Volkswagen, Audi, Seta And Skoda Master Timing Tool Set Petrol and Diesel Engines

Engine Timing Tools > Volkswagen Timing Tools

For replacing the timing belt on Diesel and Petrol engines from 1976.
To be used on VAG Group models and vehicles with the same engines; Ford, Volvo etc.

Applications:

Petrol Engines:

Audi: 80, A2, A3, S3, A4, A6, TT.

Seat: Alhambra, Arosa, Cordoba, Ibiza, Inca, Leon, Toledo.

Skoda: Fabia, Octavia (from 96).

VW: Bora, Caddy, Fox, Golf, Lupo, New Beetle, Passat, Polo, Sharan, Touran.

Diesel Engines:

Audi: 80, A2, A3, A4, A6, Cabriolet (95-00).

Platz: Alhambra, Arosa, Altea, Cordoba, Ibiza, Inca, Leon, Toledo.

Skoda: Fabia, Felicia, Octavia (93-05).

VW: Bora, Caddy, Golf, Lupo, New Beetle, Passat, Polo, Sharan, Transporter, Touran.

Engine Codes:

AFB, AKE, AKN, AYM, BAU, BCZ, BDG, BDH, BFC

Art. 1019-WW

Volkswagen, Audi, Seat And Skoda, 1.9 & 2.0 TDI Timing Kit

Engine Timing Tools > Volkswagen Timing Tools

Included: 2x injection pump locking ring,
Crankshaft Setting Tool - Bored engines,
Crankshaft Setting Tool - Non Bored engines,
Tensioner Pulley Locking Pin, Auxiliary drive
belt tensioner locking pin.

Applications:

VW: Lupo, Fox, Polo, Golf, Golf Plus, Bora,

Jetta, Beetle, Scirocco, Passat, Sharan,

Touran, Tiguan, Caddy, Transporter (98-11)

Audi: A2, A3, A4, A5, A6, Q5 (98-11). Ford:

Galaxy (00-06). Seat: Ibiza, Altea, Leon,

Alhambra, Toledo, Arosa, Cordoba (99-11)

Skoda: Fabia, Roomster, Octavia, Superb

(00-11) Mitsubishi - Grandis, Outlander 2.0

Di-D (05-11).

Art. 1019-1-WW

Engine Codes:(1.2 Tdi) ANY, AYZ.

(1.4 Tdi) AMF, ATL, BAY, BHC, BNM, BNV,

(1.9 Tdi) AJM, AMG, ANJ, ARL, ARX, ASZ,

ATD, ATJ, AUJ, AVB, AVF, AVQ, AWX, AXB,

AXC, AXR, BEW, BJB, BKC, BKE, BLS, BLT,

BMT, BPX, BRB, BRM, BRU, BSU, BSV,

BSW, BTB, BVK, BXE, BXF.

(2.0 TDi) AZV, BKD, BDJ, BDK, BGW, BHW,

BKP, BLB, BMA, BMM, BMN, BMP, BMR,

BNA, BPW, BRC, BRE, BRF, BRT, BSS, BUY,

BUZ, BVE, BVF, BVG, BVH, BVW.

Common Rail Engines:

(1.6 TDi) CAYA, CAYB, CAYC.

(2.0 TDi) CAGA, CAGB, CAGC, CAHA, CAHB,

CBAA, CBAB, CBAC, CBBA, CBDA, CBDB,

CBDC, CBEA, CEGA.



VW / AUDI FSI 2.0 Timing Tool Set

Engine Timing Tools > Volkswagen Timing Tools

For use on VAG group vehicles such as VW and Audi with 2.0LFSI and TFSI engines.

Applications: VW Golf, Touran, Audi A3.

Engine codes: AWA, BMB, AXW.

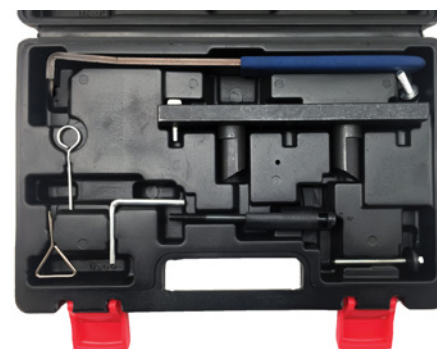

Art. 1075-WW

VAG Engine Timing Tool Set For 1.6 & 2.0 Common Rail Diesel

Engine Timing Tools > Volkswagen Timing Tools

To be used on VAG Group models with 1.6, 2.0 TDI CR engines.
Applications: Audi A3, A4, A5, A6, Q5.
Volkswagen Golf.



Art. 1076-WW

Engine Timing Tool Set for VAG 1.8 / 2.0L FSI / TFSI

Engine Timing Tools > Volkswagen Timing Tools

For use on 2.0l FSI and TFSI engines.
Engine codes: AWA, BMB, AXW.
Applications: Golf, Touran, A3.



Art. 4025-WW

Engine Timing Tool Set for VW Polo, Lupo 1.2 L 3-Cylinder engines

Engine Timing Tools > Volkswagen Timing Tools

Includes important tools for locking the camshaft and crankshaft or to review and adjust the engine timing.



Art. 4074-WW

VAG Engine Timing Tool Set For 2012 CR TDi Engines 1.6 & 2.0

Engine Timing Tools > Volkswagen Timing Tools

For Setting the engine timing on VW / 1.6L & 2.0L engines 2013 Onwards.
VW: Golf SV/Sportsvan, Golf VII, Golf VII Estate, Golf VII Wagon, Polo.
SEAT: Leon, Leon ST.
AUDI: A3 Cabrio, A3 Saloon, A3 Sedan, A3/A3 Sportback, A4, A4 allroad, A4 quattro, A5 Coupe / Cabriolet, A5 Sportback, A6, Q5, TT.
SKODA: Octavia III / Motore: 1.4TDI CR, 1.6TDI CR, 1.6TDI CR GreenLine, 1.6TDI CR BlueMotion, 1.6TDI CR Ecomotive, 2.0TDI CR, 2.0 RS TDI CR, 2.0TDI CR Ultra / Codici motore: Engine Codes:
CKFB, CKFC, CLHA, CLHB, CNHA, CNHC, CRBC, CRBD, CRFA, CRFC, CRKA, CRKB, CRLB, CRLC, CRMB, CRVA, CRVC, CSUA, CSUB, CUNA, CUPA, CUTA, CUSA, CUSB, CXEB.
OEM:
T10264 / T10265 / T10490 / T10051 / T10060A / T10492 / 3359.



Art. 4082-WW

VAG Engine Timing Tool Set For 1.2 TFSI

Engine Timing Tools > Volkswagen Timing Tools

For use on the following VAG Group models from 2009.

Audi: A1, A3, A3 Sportback, A3 Cabriolet.

Seat: Altea, Altea XL, Ibiza V, Ibiza Sportcoupe, Leon, Toledo IV.

Skoda: Fabia II, Fabia Combi, Rapid, Oktavia II, Oktavia Combi, Rommster, Yeti.

Volkswagen: Beetle, Caddy III, Golf VI, Golf Plus, Golf Cabriolet, Golf Variant, Jetta IV, Polo, Touran.

Engine Codes: CBZA ,CBZB, CBZC.



Art. 4179-WW

VAG Engine Timing Tool Set For 1.8/2.1 4V TFSi Engines

Engine Timing Tools > Volkswagen Timing Tools

VAG Group vehicles with 1.8/2.1 4v TFSi Engines.

Audi: A3, A4, A5 A6, S3, TT.

Seat: Ithambra, Altea, Exeo, Ibiza, Leon, Toledo.

Skoda: Octavia II, Octavia III, Superb II, Yeti.

VW: Amarok, Beetle / Maggiolino, CC, Eos,

Golf V, Golf VI, Golf VII, Jetta, Passat,

Scirocco, Sharan, Tiguan, Transporter.

Audi (from '07) - BPU, BYT, BZB, CAWB,

CBFA, CCTA, CCZA, CDAA, CJSB, CJSB,

CABA, CABB, CDHA, CDHB, CDNB, CDNC,

CFKA, CJEB, CNCD, CABD, CCZC, CPJA,

CJXB, CJXC, CESA, CETA, SEAT (from '06)

-CCZA, BYT, BZB, CCZB, CDAA, CDHA,

CDHB, CDND, CTHE, CTHF, CTJB, CTJC,

CJSA, CCZB.

Skoda (from '07) - BZB, CDAA, CDAB, CJSB,

CJSB, CCZA, CDAA, CDAB.

VW (from '07) BZB, CDAA, CDAB, CJSB,

CJSB, CCZA, CDAA, CDABBZB, CDAA,

CDAB, CJSB, CJSB, CCZA, CDAA, CDAB,

CDAA, CDAB, CJSB, CJSB, CCZA, CDAA,

CDAB.

OEM Tools: T10352 - Camshaft control valve

removal tool, T40267 - Chain tensioner.

T40011 - Tensioner locking pin (1.4mm).

T40271 - 1 Camshaft clamp for exhaust cam.

T40271 - 2 Camshaft clamp for inlet cam.

VAS6079 - DTi Gauge.

T40265 - Oil pump tensioner locking pin.

T10170 - TDC indicator.



Art. 4202-WW

VAG 1.8/2.0 TFSi Petrol

Engine Timing Tools > Volkswagen Timing Tools

Engine Timing Tools Set VAG.

Audi: A3, A4, A5, A6, Q3, Q5, TT.

Seat: Leon, Toledo, Altea, Altea XL, Exeo, Alhambra.

Skoda: Yeti, Octavia II, Octavia III, Superb.

Volkswagen: Golf, Beetle, Jetta, Scirocco, Eos, Passat, Passat CC, Tiguan, Sharan, Amrok.

Engine Codes:

1.8 TFSi: BYT, CDAA, CJSB, BZB, CDAB, CJSB, CABA, CDHA, CABB, CDHB, CABD, CJEB.

2.0 TFSi: CAWA, CCZB, CDND, CHHA, CPLA, CAWB, CCZC, CESA, CHHB, CPJA, CBFA,

CCZD, CETA, CJK, CCTA, CDNB, CFKA, CJK, CCZA, CDNC, CFPA, CNCD.

OEM Ref: T10368, T10352, T10352/1, T10352/2, T40011.



Art. 51009-WW

2-Piece Ignition Coil Puller For Opel-Vauxhall

Engine Timing Tools > Volkswagen Timing Tools

Special design for pulling out the ignition coil.

For Opel, VW and other applications: 3- BZW.

4-ZYLINDER BENZIN-EINSPRITZMOTOREN.

Z.BBEI OPEL AGILA-A, ASTRA-F, ASTRA-G,

ASTRA-H, ASTRA-J, CALIBRA, COMBO,

CORSA-B, CORSA-C, CORSA-D,

FRONTERA-A, FRONTERA-B, INSIGNIA,

MERIVA-A, MERIVA-B, OMEGA-B, SIGNUM,

TIGRA-A, TIGRA-B, VECTRA-B, VECTRA-C,

ZAFIRA-A, ZAFIRA-B (MOTORCODE:

LDD, LDE, LLU, LUH, LUJ, 2HO,

A10XEP, A14NEL, A14NET, A14XER,

X14NZ, X14SZ, X14XE, A16LET,

A16XER, X16SZR, X16XE, X16XEL,

A18XER, X18XE, X20SE, X20XEV,

X22SE, X22XE, Y22SE, Z10XEP,

Z12XE, Z12XEP, Z14XE, Z14XEL,

Z14XEP, Z16LEL, Z16LER, Z16LET,

Z16XE, Z16XER, Z16YNG, Z18XE,

Z18XER, Z20LEH, Z20LER, C22SEL.



Art. 7029-WW

Engine Timing Tool Set For Vag 1.4 / 1.6 FSI

Engine Timing Tools > Volkswagen Timing Tools

Designed for checking and adjusting the camshaft.

Required when replacing timing chains.

Applications.

VAG FSI and TFSI 1.4L and 1.6L engines.

Audi A3 (03-10),

Seat Ibiza , Leon, Altea.

Skoda Octavia (04-09), Fabia (07-09), Superb (09-10), Roomster (06-09).

VW Golf (03-09), Golf Plus (05-09), Jetta (06-09), Passat(05-09),

Polo (02-08), Scirocco (09-10), Tiguan (07-09), Touran(03-09), Eos (06-09).

OEM Tools.

Camshaft locking tool: OEM T10171.

Setting gauge holder: OEM T10170.

Crankshaft locking tool: OEM T10340.

Tensioner locking tool: OEM T40011.

Engine Codes.

AXU, BLG, BAG, BMY, BKG, BMK, BLF,

CAVA, BLN, CAVB, BLP, CAVC, CAVE, CAVF,

CAVD, CAXA, CAXC, CDGA,BTS.



Art. 800031-UTC

Engine Timing Tool Set For VAG 2.5, 4.9, TDI PD

Engine Timing Tools > Volkswagen Timing Tools

This kit has been designed to set and adjust the timing on VAG 5 and 10 cylinder engines.

Applications.

VW T5 (from 2004), VW Touareg (from 2003), VW Phaeton (from 2003) with 5 and 10 cylinder engines.

OEM Tools.

Camshaft locking tool for review and adjustment, suitable for 5 and 10 cylinder engines: OEM T10193.

Camshaft locking tool for review and adjustment of 10 cylinder engines: OEM T10194.

Clamping device for removal and replacement of the camshaft sprockets of 5 and 10 cylinder engines: OEM T10199.

Special socket for rotating the crankshaft of 5 cylinder engines: OEM T10225.

Crankshaft locking wrench for 5 cylinder engines: OEM T10226.

Tensioner wrench.



Art. 800035-UTC

Engine Timing Tool for VW and Audi, 1.2/1.4/1.6 FSI and 1.4 TSI

Engine Timing Tools > Volkswagen Timing Tools

Updated kit for TFSi/FSi VAG engine. Applications: 1.4/1.6FSi Also 1.4 TSi and 1.2TFSi/FSi engines.

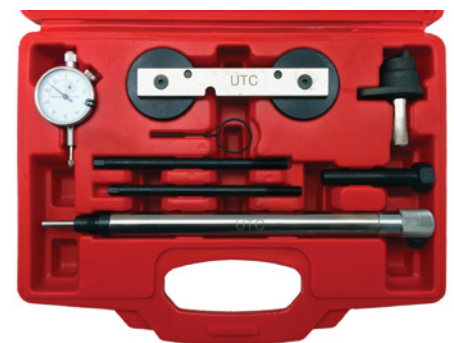

Art. 800053-UTC

Citroen & Peugeot Timing Set

Engine Timing Tools > Citroen Timing Tools

Designed for setting and adjusting the timing on Citroen and Peugeot 16 valve engines (1.8 and 2.0L).

Applications:

1.9D, 2.0D, 2.2D found in Citroen, Peugeot, Fiat and Toyota.

Engine codes:

DW8, DW10, DW12, XUD, TUD, XU, TU.

Included:

Fuel injection pump shaft.

Timing belt tensioner.

Flywheel.

Crankshaft.

Camshaft.

Belt pulley.



Art. 1023-WW

Engine Timing Tool Set Citroen / Peugeot

Engine Timing Tools > Citroen Timing Tools

This kit has been designed for the setting and adjusting of the timing in PSA engine.
Applications: PSA models with HPI(petrol) or HDI (diesel) engine & (Twin Cam 16v Petrol Engine).

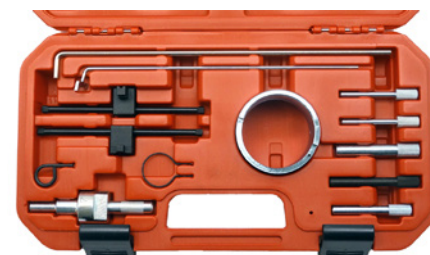

Art. 1071-WW

Citroen & Peugeot Timing Tool Set 1.8, 2.0, 2.2 EW7, EW10, EW12 Petrol

Engine Timing Tools > Citroen Timing Tools

For EW coded PSA engine used on Citroen and Peugeot.- 1.8, 2.0, 2.2 EW7, EW10, EW12 Petrol

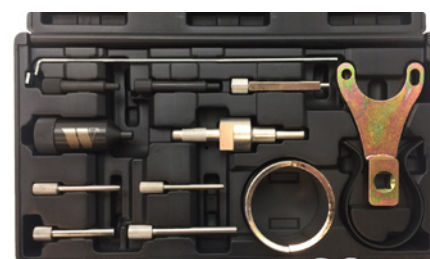

Art. 51007-WW

Citroen & Peugeot Master

Engine Timing Tools > Citroen Timing Tools

Engine adjustment tool set for PSA (Peugeot / Citroen).

Contains important tools e.g. for the following jobs:

- Locking the flywheel.
- Locking the crankshaft.
- Locking the camshaft.
- locking the injection pump shaft.
- Removing the crankshaft pulley.
- Tensioning the toothed belt.

Suitable for petrol engines:

- 1.9l - 1.1l - 1.4l - 1.6l - 1.8l - 1.9l - 2.0l.
- 1.6l - 1.8l - 2.0l - 2.2l 16V (turbo and double camshaft).

Diesel engines: 1.4l - 1.5l - 1.7l - 1.8l - 1.9l - 2.1l - 2.5l D / TD / TDI.

1.4l - 1.6l - 2.0l - 2.2l HDI.

Also suitable for identical engines from e.g. Fiat, Ford, Nissan, Renault, Rover, Toyota etc. e.g. for engine codes:

1KRFE, 1NDTV, 2WZTV, 3FY, 3FZ, 4HK, 4HL, 4HN, 4HP, 4HR, 4HS, 4HT, 4HW, 4HX, 4HY, 4HZ, 6FY, 6FZ, 8HX, 8HY, 9HX, 9HY, 9HZ, A9A, BDY, BDZ, BFZ, CDY, CDZ, D4164T, D6A, D6B, D6D, D8B, D8C, D9B, DDZ, DFZ, DHX, DJ5, DJ5T, DJ5TED, DJY, DKATE, DKZ, DKZDFZ, DV4TD, DV4TED4, DV6ATED4, DV6TED4, DW8, DW8B, DW10ATD, DW10ATED, DW10ATED4, DW10BTED, DW10BTED/L3, DW10CTED4, DW10JATED4, DW10TD, DW10UTD, DW12ATED, DW12ATEDL/L4, DW12BTED4, DW12CTED4, DW12MTED4, DW12TED4/L4, DW12UTED, EW10A,

EW10ABE4, EW10D, EW10J4, EW10J4D, EW10J4S, EW10L4, EW10L5, EW12J4, EW12L4, EW12L5, EW7A, EW7J4, EW7JP4, F6JA, F6JB, F6JC, F6JD, G8DA, G8DB, G8DC, G8DD, G8DE, G8DF, GPDA, GPDB, GPDC, HDY, HHDA, HHDB, HHJA, HHJB, HHJC, HHJD, HHJE, HHJF, K9A, KDX, KDY, KFW, KFX, KFZ, L6A, LFX, LFY, LFZ, MTD, NFT, NFU, NFV, NFW, NFX, NFY, NFZ, P8A, P8B, P9A, PHZ, RDZ, RFH, RFJ, RFX, RFL, RFN, RFR, RFS, RFT, RFU, RFV, RFW, RFX, RFY, RFZ, RGX, RGY, RHA, RHE, RHF, RHG, RHH, RHJ, RHK, RHM, RHR, RHS, RHT, RHV, RHW, RHX, RHY, RHZ, RLZ, T8A, T9A, THX, THY, THZ, TU1, TU3, TU5J4, TU5JP, TU5L3, TU9, TUD3, TUD5, TZJB, UBJA, VJX, VJY, VJZ, WJY, WJZ, XU10J2, XU10J4, XU5, XU7, XU7JP4, XU9, XUD11A, XUD11ATE, XUD11BTE, XUD7, XUD7TE, XUD9A, XUD9AU, XUD9AY, XUD9BTF, XUD9TE, XUD9TFL, XUD9TFY, XUD9UTF, Y6



Art. 60036-WW

Renault Master Timing Set

Engine Timing Tools > Renault Timing Tools

For setting the timing on chain and belt driven engines on Lagunas 2.2d/TD, Safrane 2.2Td, Espace 2.2TD, Trafic 2.5D.

Works as OEM: MOT1348, MOT1312, MOT1135 -01, MOT1384, MOT1337, MOT1496, MOT910-1, MOT910-2, MOT861, MOT863, MOT1054, MOT1318, MOT1498, MOT1340, MOT1386, MOT1490-1.

Compatible for the following Renault engine sizes:

Petrol: 1.2, 1.4, 1.6, 1.7, 1.8, 2.0, 2.2 litre.

Diesel: 1.9, 2.5, 2.8 litre.

16-Valve: 1.4, 1.6, 1.8, 2.0 litre.

20-Valve: 2.5 litre.

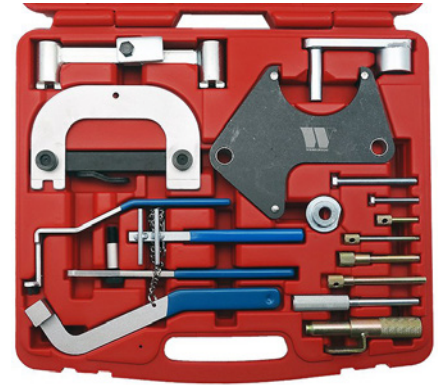

Art. 1025-WW

Opel Renault Nissan 1.5/1.9/2.2/2.5 DCI (VANS) Timing Tool Set

Engine Timing Tools > Renault Timing Tools

Designed for setting the timing on Renault, Opel, Nissan, Dacia - 1.5, 1.9, 2.2, 2.5 DCI.

Renault: Avantime, Clio II-III, Clio Sport, Espace, Kangoo, Master, Megane I-II, Modus, Laguna I-II, Scenic I-II, Trafic, Twingo.

Opel: Movano, Vivaro.

Nissan: Almera, Interstar, Kubistar, Micra, Note, Primastar, Primera, Qashqai.

Dacia: Logan.

Engine code: K9K, F9Q, G9T, G9U.

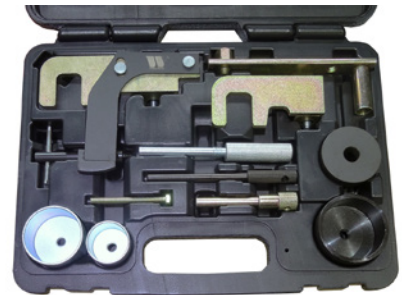

Art. 4156-WW

Diesel Camshaft/Head Rebuild Kit - VAG & Porsche

Engine Timing Tools > Renault Timing Tools

For fitting camshafts in cylinder head.

Applications: Audi A4 2001>, Audi A6 2005>, Audi A8 2003> 6-cyl. TDI Common Rail 2.7L and 3.0L 4-valve engine 8-cyl. TDI Common Rail 4.0L 4-valve engine. Porsche.

Skoda: Roomster, Fabia, Praktik, Octavia, Yeti, Superb.

Audi: A1, A3, A4, A5, Q5, A6, TT.

VW: Jetta, Touran, Golf, Golf Plus, Polo, Passat, Tiguan, Scirocco.

Seat: Exeo, Leon, Altea, Toledo, Ibiza.

Engine: 1.2 TDI CR, 1.6 D TDI CR, 2.0 D TDI CR.

Engine codes: CAGA, CAGB, CAGC, CAHA, CAHB, CFHC, CBAA, CBAB, CFFB, CGLA, CGLB,

CJCA, CJCB, CAAA, CBAC, CBBA, CBBB, CBDA, CBDB, CBDC, CCHA, CEGA, CJAA, CAAB,

CAAC, CJFA, CFWA, CAYB, CAYC, CAYA

OEM Ref: T40094, T40095, T40096



Art. 7002-WW

Watch Online!



UNIVERSAL WISHBONE LEVER

SAVE TIME & MONEY: VIDEO ONLINE >>

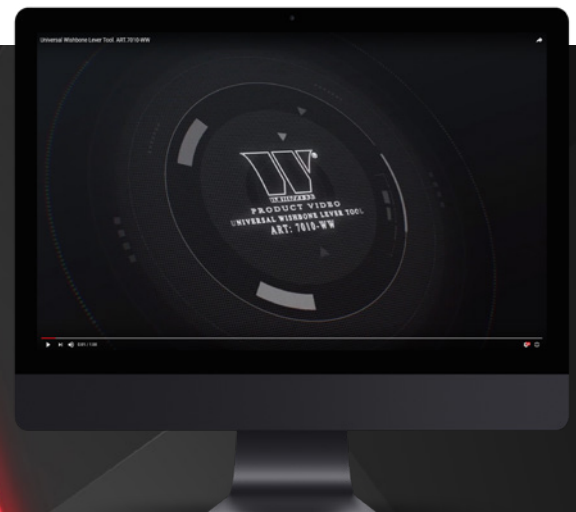

Engine Timing Tool Set Renault 1.4/1.6/2.0 16V

Engine Timing Tools > Renault Timing Tools

This kit has been designed for the correct timing on Renault K4J, K4M 1.4, 1.6 16V & F4P, F4R 1.8, 2.0 16V engines when changing the timing belt.

Applications:

Clio 1.4, 1.6 16V (98-06).
Megane 1.4, 1.6 16V (98-06).
Clio Sport 2.0 16V (98-06).
Megane 1.8, 2.0 16V (98-04).
Espace 2.0 16V (98-04).
Megane II 1.4 16V (02-09).
Grand Scenic II 1.4/1.6 16V (02-09).
Megane II 1.6 16V (02-05).
Laguna 1.6 16V (98-06).
Megane II 2.0 16V (02-09).

Laguna 1.8 16V (01-05).
Scenic 1.4, 1.6 16V (98-06).
Laguna 1.8, 2.0 16V (98-04).
Scenic 1.8, 2.0 16V (98-04).
Laguna II 2.0 16V T (02-09).
Scenic II 1.4, 1.6, 2.0 16V (02-09).



Art. 4157-WW

Diesel Engine Setting-Locking Tool Set For Renault-Nissan 1.5-1.9dci, Suzuki DDiS, Dacia Dci Belt Driven

Engine Timing Tools > Renault Timing Tools

Designed to remove the timing belt quickly.

Suitable for Renault Laguna, Clio and Kangoo with 1.5 and 1.9 DCI engines.

Crankshaft locking pin should be used as OEM: MOT 1489.

Camshaft / crankshaft timing pin to use as: OEM 0194B, 999-7122, 21-263, MOT 1430, 0187B, 0189B.

TDC Timing Pin to use as: KM603 OEM, MOT 1054 MOT 861 MOT 863.

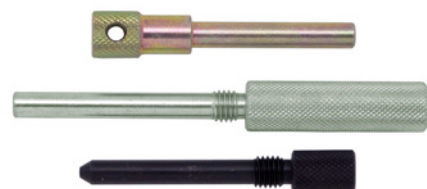

Art. 4159-WW

Flywheel Front Pulley Locking Tool Set - Renault & Nissan

Engine Timing Tools > Renault Timing Tools

Flywheel and front pulley locking tool set for Renault.

issan chain driven petrol engines: 1.4/1.6/2.0/2.5/3.5.

Applications: Renault twin cam, chain driven petrol engines also fitted to Nissan.

Engine Codes: H4JT (1.4), M5M (1.6), MR4 (2.0), 2TR (2.5), V4Y (3.5).

Equivalent to OEM MOT 919-02, MOT 1431, MOT 1716, MOT 2019, MOT 1789.

Can also be used for M9R (2.0 diesel) to be used in conjunction with 2110-WELZH.



Art. 8054-WW

26-Piece Engine Timing Tool Set For BMW Engines, N42, N46

Engine Timing Tools > BMW Timing Tools

This kit has been designed to allow setting and adjusting of the timing on BMW models with N42, N46, B18/-A, B20/-A/-B engine codes.

Applications: BMW: 1, 3, 5, X3, Z4 (models: E87-46-60-85-83-90-91).

Contains important tools for camshaft assembly and disassembly also for valve timing of camshafts.

Included OEM tools:

clamps for intermediate lever: OEM 119310.

bearing bridge holder: OEM 119320.

Thumbscrew: OEM 119302.

Eccentric shaft holder: OEM 119301.

Camshaft locking tool: OEM 119290.

Camshaft locking tool (inlet): OEM 119302.

Clamping tool: OEM 11940.

Spring holder: 119390.

Camshaft sensor tool: OEM 119350.

Screw: OEM 119390.

Camshaft rotation key: OEM 119270.

Crankshaft locking tool (straight): OEM 112300.

Mounting bolts 3x: OEM 119320.

Screw: OEM 119290.

Camshaft locking tool, to be used as OEM 119290.

Crankshaft locking tool (angled): OEM 119190.

Mounting bolts: OEM 119320.

Setting tool for balancer shaft: OEM 119330.



Art. 1059-WW

Diesel Injection Fuel Pump Puller BMW

Engine Timing Tools > BMW Timing Tools

To be used on 2.5 TDS engines in BMW (E34, E36, E38), Land Rover, Vauxhall/Opel. BMW OEM: 13-5-120. Land Rover OEM: LRT12-119. Vauxhall/Opel OEM: KM 825.



Art. 4012-WW

Engine Timing Tool Set for BMW N43

Engine Timing Tools > BMW Timing Tools

This tool kit has been designed to check, adjust and set the camshaft timing and for the removal/replacement of the cam chain.

The kit also includes the VANOS plates which is required to set the VANOS sensor in the correct position and the alignment tool is required to set the balancer shaft.

Camshaft locking tool.

Vanos sensor alignment too.

Chain tensioner locking pins (2).

Balance shift locking tool.

Flywheel locking tool.

Chain tensioner.



Art. 4075-WW

Diesel Engine Setting-Locking Tool Set For BMW N47-57, 2.0-3.0 ltr Chain Drive

Engine Timing Tools > BMW Timing Tools

Mounting of the camshaft replacing the timing chain and cylinder head gasket.

Suitable for the following applications:

116d 118d 120d 123d, type E81 E82 E87 E88 F20.

316d 318d 320d 325d 330d type E90 E91 E92 E93 F30.

520d 525d 530d 530d GT 535d 535d GT M550d,.

type E60 E61 F07 F10 F11.

640d type F12.

730d 740d 750d, type F01.

X1 1.8d 2.0d 2.3d, type E84.

X3 1.8d 2.0d 3.0d, 3.5d type E83 F25.

X5 3.0d 4.0d M5.0d, type E70.

X6 3.0d 4.0d M5.0d, type E71.



Art. 4161-WW

Engine Timing Tool Set For Bmw-Mini-Citroen-Peugeot 1.4/1.6 N12

Engine Timing Tools > BMW Timing Tools

BMW Mini / PSA with 1.4 / 1.6 Valvetronic engine- Engine codes N12 / N14- 1.4 VTi - EP6 8Fs, 1.6VTi - EP6 5FW,- 1.6 THP - EP6DT 5FX, 1.6 THP - EP6DTS 5FY.



Art. 51004-WW

Engine Timing Tool Set for BMW M52; M54; M60; M62

Engine Timing Tools > BMW Timing Tools

For EW coded PSA engine used on Citroen and Peugeot.- 1.8, 2.0, 2.2 EW7, EW10, EW12 Petrol.



Art. 51006-WW

Engine Timing Tool Set for BMW N42 / N46 / N46T

Engine Timing Tools > BMW Timing Tools

For adjusting / checking the engine timing and vanos unit.
Suitable for following BMW models:

E81 (116i / 118i / 120i) - E87 (118i / 120i).
E88 (120i) - E46 (316i / 316ti / 316i / 318ci / 318ti).
E90 (318i / 320i) - E91 (318i / 320i) - E92 (320i).
E93 (320i) - E60 (520i) - E83 (X3 2.0) - E85 (Z4 2.0).

Includes the following tools:

Pre-tensioning tool (OEM 119340).
Sensor gear alignment tool (OEM 119350).
Inlet camshaft locking tool (OEM 119292).
Exhaust camshaft locking tool (OEM 119291).
Flywheel locking pin (OEM 115120).
Camshaft alignment tool (OEM 119270).
Screw for camshaft locking tool (OEM 119293).

Art. 60075-WW



BMW Timing Tool Set S54

Engine Timing Tools > BMW Timing Tools

Designed for setting and adjusting the camshaft timing when installing the VANOS adjustment unit on BWM S54 engines.

Applications: BMW M3.



Art. 1241-WW

Engine Timing Tool Set For Opel / Vauxhall 1.0/1.2/1.4 Chain Driven Petrol Engines

Engine Timing Tools > Vauxhall Timing Tools

For setting and adjusting the timing on Opel/ Vauhall models:

Applications:

Adam 1.2 LWD - 1.4 L2Z - 1.4 LDD (2012).
Ampera 1.4 LUJ / A14XFL (2011).
Astra J 1.4 LDD / A14XER - 1.4 LDD / A14XEL / 1.4 LUJ / A14NET - 1.4 LUJ / A14NEL / 1.4 LUJ / A14NET (2009).
Corsa D 1.0 A10XEP - 1.2 A12XEL - 1.2 A12XER / 1.4 A14XEL - 1.4 A14XER - 1.2 A12XER / 1.4 A14NEL (2009).
Insignia 1.4 LUJ / A14NET (2011).
Meriva B 1.4 LDD / A14XER - 1.4 LUJ / A14NET / 1.4 LUH / A14NEL (2010).
Mocha 1.4 LUJ / A14NET (2012).

Zafira Tourer C 1.4 LUJ / A14NEL / 1.4 LUJ / A14NET (2011) Aveo 1.2 L2Q / A12XEL - 1.2 LDC / A12XER / 1.2 LWD / A12XEL- 1.4 LDD / A14XEL / 1.4 LDD / A14XER (2011).

OEM Tools.

Camshaft sensor disc setting tool: OEM EN-49977-100.

Intake camshaft adjusting tool: OEM EN-49977-200.

Camshaft sensor positioning tool: OEM EN-49978.

Chain tensioner pin 4 mm: OEM KM 955-1.

Belt tensioner pin 2.5 mm: OEM KM 955-2.

2x camshaft locking tool: OEM KM-952 / 953-A.



Art. 1174-WW

Opel/ Vauxhall 26-piece timing tool set

Engine Timing Tools > Vauxhall Timing Tools

To be used for locking the camshaft and crankshaft, removal and assembly of injection and water pumps and changing the timing belt.

Can be used on Vauxhall and GM vehicles with 1.3 CDTi 16V, 1.9 CDTi, 2.0 DTi and 2.2 DTi diesel engines.

Vauxhall Z19 DT/Z 19 DTH Engine e.g.

Vectra C, Signum, 04.

Vauxhall Z13 DT Engines e.g.

Corsa and Combo, 04.

Vauxhall Z22 SE Engine e.g.

Astra G Vectra C.

Zafira, Signum, Speedster Vx220, 00- 04.

Vauxhall With 1.0L-12V, 1.2L and 4L 16V

Petrol Engines (X10XE, Z10XE, Z10XEP, X12XE, Z12XE, Z14XEP) e.g.

Corsa, Agila, Astra and Meriva.

Vauxhall 2.0L and 2.2L Ecotec Diesel-Engines (X20DTL, X20DTH, X22DTH) I.E.

Astra, Astra, Caravan Zafira Vectra Omega, Sintra and Frontera.



Art. 1073-WW

Timing Tool Set For Opel / Vauxhall 1.0,1.2, 1.4 Twin Cams

Engine Timing Tools > Vauxhall Timing Tools

This set includes all the tools to time the chain on 1.0, 1.2, 1.4l EcoTec twin cam engines.

Applications: Vauxhall/Opel; Agila (00-08), Corsa-B (97-00).



Art. 4155-WW

Diesel Engine Setting Locking Tool Kit For Vauxhall/Opel, Saab, Fiat, 1.9, CDTi/Tid/TTid, 2.0D,CDTi Belt Drive

Engine Timing Tools > Vauxhall Timing Tools

The tool has been designed for setting the timing on Vauxhall, Saab, Fiat 1.9 CDTi, TiD, TTid and 2.0l D CDTi belt drive engines.

Applications:

Vauxhall/Opel: Astra-H (04-11), Astra-J (10-12), Insignia (08-12), Signum (04-08), Vectra-C (04-08), Zafira-B (05-12).

Saab: 9-3 (04-10), 9-5 (05-10).

OEM tools: EN-46788/32 025 009, EN-46789, 32 025 008, KM-6349/87 92 335.

Engine codes: Z19DT, Z19DTH, Z19DTJ, Z19DTL, Z19DT, Z19DTH, Z19DTR, A19DTR, Z19DTR, LBQ/A20DTL, LBR/A20DT, LBS/A20DTH, LBX/A20DTJ, LBY/A20DTR, LCD/A20DTC, LBS/A20DTH, LBY/A20DTR.



Art. 4163-WW

Engine Timing Tool Set For Opel 1.6, 1.8 16v Z series

Engine Timing Tools > Vauxhall Timing Tools

This kit has been designed for GM engines found in Vauxhall, Alfa, Fiat and Chevrolet 1.4, 1.6, and 1.8, 16v engines.

Set includes:

Camshaft Locking Bar, OEM KM-6628-A.

Camshaft Pulley Locking Tool x 2, OEM KM-6340.

Tensioner Locking Pin, OEM KM-6333.

Fly Wheel Holding Tool, OEM KM-6625.

Locking Pin, OEM KM-6349 / KM-6130.

Flywheel Holding Tool, OEM KM-911.

Engine Codes: 1.6 16v- A16LEL, A16LER,A16LET/LLU, A16XER, A16XER/LDE,A16XNT, A16XNT/LGE, Z16XE1,Z16XEP, Z16XER,Z16LEL, Z16LET, Z16LER, Z16XNT.

1.8 16v-A18XEL/2HO, A18XER, A18XER/2HO, Z18XER, ALFA & FIAT 1.8 16V, 939A4.000 Engine. CHEVORLET 1.4/1.6/1.8 ENGINE G14D, LDE, LLU, LXV, & 2HO.

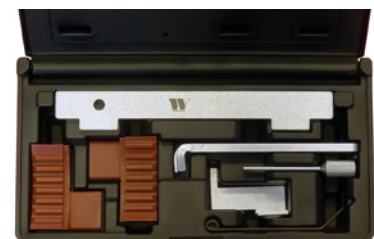

Art. 4164-WW

Engine Timing Kit Vauxhall/Opel 1.6CDTi

Engine Timing Tools > Vauxhall Timing Tools

For locking the 1.6 diesel engine into its timed position for the removal & replacement of the timing chain for the following applications: Astra-J, Meriva-B, Mokka, Zara-C, Tourer 2013 onwards.



Art. 5006-WW

Opel / Vauxhall Engine Timing Tool Set

Engine Timing Tools > Vauxhall Timing Tools

Kit includes tools to lock the camshaft and the crankshaft.

Applications:

Opel Z 19 DT / Z 19 DTH: Vectra C and Signum 04.

Opel Z13 DT: Corsa and Combo 04.

Opel with Z 22 SE: Astra G, Vectra C, Zafira, Signum and Speedster Vx220, 00 - 04.

Opel 1.0l - 12V, 1.2l and 1.4l 16V: Corsa, Agila, Astra and Meriva.

Opel 2.0l and 2.2l Ecotec: Astra, Astra, Caravan, Zafira, Vectra, Omega, Sintra and Frontera.

Engine codes: OHC, DOHC, Z13, Z22, X10XE, Z10XE, Z10XEP, X12XE, Z12XE, Z14XEP, X20DTL, X20DTH, X22DTH.

Also suitable for Renault and Saab vehicles with the same engine.



Art. 800011-UTC

Engine Timing Chain Tool Kit - Vauxhall/Opel 1.6 SIDI Petrol

Engine Timing Tools > Vauxhall Timing Tools

Applications: SIDI Turbo, SIDI Turbo EcoFLEX: Vauxhall: Astra -J 2013-2015, Cascada 2013-2015, Insignia 2013-2016, Insignia Country Tourer 2014-2016 and Zafira-C Tourer 2013-2016.
OEM: SIDI TURBO, SIDI TURBO ECO FLEX.



Art. 8052-WW

Engine Timing Tool Kit - Vauxhall/Opel 2.0CDTi

Engine Timing Tools > Vauxhall Timing Tools

2.0CDTi timing belt tool kit for Opel/Vauxhall for removal and replacement of the camshaft drive belt. The kit also contains the tool required lock the flywheel on vehicles fitted with automatic transmission.

Application: Opel/Vauxhall 2.0 CDTI - LFS/B20DTH from 2014- Onwards.

Models: Cascada 2015-2017, Insignia 2014-2017, Insignia Country Tourer 2014-2017 and Zafira-C Tourer, CDTi EcoFLEX.

OEM Equivalent to EN 51413, EN 955-2, EN 51412, EN 51414, EN 51411.

Welzh 8052-WW is for the Drive Chain in the cylinder head Kit.



Art. 8053-WW

Vauxhall, Opel, Nissan, Renault Timing Tool Set For 2.0DCi M9R Engines

Engine Timing Tools > Vauxhall Timing Tools

To be used for setting the timing on Nissan and Renault vehicles with M9R engine codes.

Included:

Includes a Crankshaft Holding Tool.
Auxiliary Belt Tensioner Locking Pin.
Crankshaft Pulley Holding Tool.
Camshaft Setting Tool.
Camshaft Gear Alignment Bracket.
Crankshaft Locking Pin.
Chain Tensioner Locking Pin.
M6 Bolt.
4mm Hex Key.
Applications:
Nissan M9R: 780, 830, 832, 833.
Qashqai (07-).

X-trail (07-).
Primastar (08-).
Renault M9R 700, 721, 722, 724, 740, 742, 746, 760, 761, 780, 802, 803, 805, 830, 832, 833.
Espace Mk4 (06-).
Grand Scenic Mk2 (05-) Mk3 (09- Automatic).
Koleos (08-).
Laguna Mk2 (05-) Mk3 (07-).
Megane Mk2 (05-).
Scenic Mk 2 (05-) Mk3 (09- Automatic).
Traffic Mk2 (06-) Mk3 (2010-).
Vel Satis (05-).
Vauxhall M9R 780, 782, 784.
Vivaro (06-).



Art. 2110-WW

Petrol Engine Setting/Locking Kit Alfa Romeo Fiat Lancia 1.2 16v, 1.4 16v 1.4 T Jet - Belt

Engine Timing Tools > Alfa Romeo Timing Tools

For adjusting the engine timing during timing belt replacement, cylinder head repair, replacement of the cylinder head gasket, etc. Suitable for Alfa Romeo, Fiat and Lancia 1.2 16V / 1.4 16v / 1.4 T-Jet.

Engine codes e.g. 169A3000, 179B9000, 182B2000, 188A5000, 192B2000, 198A1000, 198A4000, 199A6000, 199A8000, 843A1000.

Includes the following tools:

Crankshaft locking tool (with screws M6x30 and 3 pcs. M8x16) to be used as OEM 2.000.004.500.
Camshaft adjusting tool (1 pair) to be used as OEM 1.860.985.000.
Adjusting tool for piston height to be used as

OEM 1.860.992.000.

Adjusting tool for timing belt tensioner to be used as OEM 1.860.987.000.

Locking tool for camshaft sprockets (with screw M8x30) to be used as OEM 2.000.015.800.

Technical data.

To be used as OEM1.

2000004500 | 1860985000 | 1860992000 |

1860987000 | 2000015800 Alfa Romeo.

To be used as OEM2.

2000004500 | 1860985000 | 1860992000 |

1860987000 | 2000015800 Fiat.

To be used as OEM3.

2000004500 | 1860985000 | 1860992000 |

1860987000 | 2000015800 Lancia.



Art. 4077-WW

High Pressure Pump Sprocket Puller For Common-Rail Hyundai & Kia

Engine Timing Tools > Alfa Romeo Timing Tools

To remove the high pressure pump sprocket when dismantling the high pressure pump on common rail diesel vehicles from Hyundai and Kia.

Suitable for following vehicles:

Kia Carens (un), Cee'd (ed) & (jd), Optima (tf), Rio (ub), Soul (am), Sportage (sl) & (sle), Venga (yn), Soul (ps), Hyundai Matrix, Getz, i30.

Engine codes: 1.1D (tci-u2), 1.4D (tci-u2), 1.6D (tci-u2), 1.7D (tci-u2), 1.6 Tci (u2), 1.4 Crdi (u2), 1.6 Crdi (u2).

Contains: high pressure pump removal tool, to be used as OEM 093312a010, consisting of base plate, sprocket stopper, mounting screws.



Art. 8055-WW

Diesel engine locking Set

Engine Timing Tools > Ford Timing Tools

Body dents can now easily be removed by working the sliding hammer.

3 replaceable strainers: Ø 70mm, Ø 100 mm, Ø 125 mm.



Art. 1088-WW

Engine Timing Tool Set For Ford / Volvo 1.6 EcoBoost

Engine Timing Tools > Ford Timing Tools

This kit has been designed for setting and adjusting the timing on 1.6L direct injection petrol engines fitted with variable valve timing. This engine can be found in Ford models and Volvo models with the same set up.

Applications:

Ford B-MAX 1.6 IQJA 2012.

C-MAX, 1.6 JQDA 2010, C-MAX, 1.6 JQDB

2010, C-MAX, 1.6 JTDA 2010, C-MAX, 1.6

JTDB 2010, Focus, 1.6 JQDA 2011, Focus, 1.6

JQDB 2011, Focus, 1.6 JTDA 2011.

Focus, 1.6 JTDB 2011, Galaxy, 1.6 JTWA 2010.

Galaxy, 1.6 JTWB 2010, Grand C-MAX, 1.6

JQDA 2010, Grand C-MAX, 1.6 JQDB 2011.

Grand C-MAX, 1.6 JTDA 2010.

Grand C-MAX, 1.6 JTDB 2011.

Mondeo, 1.6 JTBA 2010.

Mondeo, 1.6 JTBB 2010.

S-MAX, 1.6 JTWA 2010.

S-MAX, 1.6 JTWB 2010.

Volvo, S60 1.6 B4164T3 2011.

S60, 1.6 B4164T 2011.

S60, 1.6 B4164T2 2011.

S80, 1.6 B4164T 2010.

S80, 1.6 B4164T2 2011.

V60, 1.6 B4164T3 2011.

V60, 1.6 B4164T 2011.

V60, 1.6 B4164T2 2011.

V70, 1.6 B4164T 2010.



Art. 1173-WW

Engine Timing Tool Set For Volvo T4 and T5

Engine Timing Tools > Ford Timing Tools

This kit has been designed for setting and adjusting the timing on Volvo models with T4 and T5 engines.

Applications:

Volvo T4, 1.6L.

Volvo T5, 1.6L.

Volvo T4, 2.0L.

Volvo T5, 2.0L.



Art. 1229-WW

Engine Timing Tool Set For Ford EcoBoost 2.0L

Engine Timing Tools > Ford Timing Tools

For setting and adjusting the timing on chain driven 2.0L petrol engines with direct injection and variable valve timing.

Applications:

Ford: Galaxy, Mondeo, S-Max, Focus.

Engine codes: TNWA, TNBA, TPWA, MGDA, XQDA.

OEM Tools:

Crankshaft locking tool: 303-748.

Camshaft alignment plate, (up to 05.2011): OEM 303-1504.

Camshaft alignment plate (after 05.2011): OEM 303-1565.

Alignment tool for crankshaft position sensor: OEM 303-1521.

2 mm tensioner locking pin.



Art. 1230-WW

Engine Timing Tool Set For Ford

Engine Timing Tools > Ford Timing Tools

Included:

Crankshaft.

Camshaft / pump shaft.

Fuel injection pump shaft.

Belt pulley.

Tensioning of the timing belt.

Includes adjusting gauge for camshaft, crankshaft, pumpshaft and flywheel.

Applications:

1.4 ltr. + 1.6 ltr 16V + 1.7 ltr. + 1.8 ltr. 16V + 2.0 ltr. 16V (also Zetec).

1.4 ltr. - 1.6 ltr. - 1.8 ltr. and 1.9 ltr. D/TD/TDCi.



Art. 2111-WW

Belt Tensioner Wrench, Ford Duratorq Engines

Engine Timing Tools > Ford Timing Tools

Designed for Ford Mondeo models with Duratorq 2.0, 2.2l TDDi/TDCi engines.
Suitable for engines with D5BA, D6BA, HJBA, B, HJBC, FMBA, N7BA, QJBB and QJBA engine codes.
OEM: 303 676.



Art. 4011-WW

Engine Timing Tool kit - Ford EcoBoost 1.0 Belt Drive 3 Cylinder

Engine Timing Tools > Ford Timing Tools

Designed for setting and adjusting the timing on Ford models with 1.0L 3 cylinder ecoboost engines.

Applications:

Focus (12-), Fiesta (13-), B-Max (12-), C-Max (12-), Transit Connect (13-), Ecosport (13-), Grand C-Max (12-), Tourneo Connect(14-), Mondeo (14-), Transit Courier (14-).

Engine Codes:

M1DA, M1JA, M1JE, M2DA, M2GA, P4JA, P4JB, SFJA, SFJB, XMJA, XMJB.

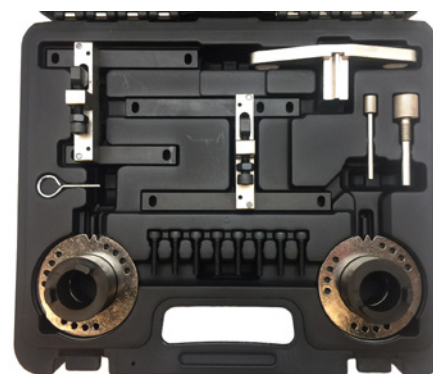

Art. 4015-WW

5-piece Engine Timing Tool Set for Ford Focus 1.6 TI-VCT & 2.0 TDCI Engines

Engine Timing Tools > Ford Timing Tools

This timing tool set includes indispensable tools for checking and adjusting your engine's control times or replacing its tooth belt. This set is suitable for Ford Focus 1.6 TI-VCT, engine type HXDA (2003-2007) and 2.0 TDCI engines, engine types G6DA, G6DB, G6DC (2003-2007).



Art. 4076-WW

Diesel Engine Timing And Injection Pump Tool Kit For Ford Duratorq 2.0

Engine Timing Tools > Ford Timing Tools

This kit has been designed for setting and adjusting the timing on Ford models with 2.0 and 2.4 16v TDCi engines.

Applications: Mondeo, Transit ('01-'04) etc.

Engine codes: FMBA / B, D5BA, ABFA, D3FA, F3FA, D2FA, D4FA, F4FA.

This kit is especially needed when making chain changes, engine repairs and work on the injection pump.

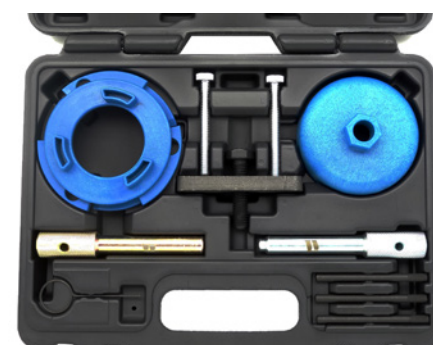

Art. 4171-WW

Stretch Belt Fitting Tool Dual Size Pulleys

Engine Timing Tools > Ford Timing Tools

For use on dual size pulleys particularly with the Ford Focus.
This kit has been designed especially for installing and dismantling stretch belts on double pulleys.
Save huge amounts of time by installing in one action.



Art. 4217-WW

Engine Timing Tool Kit Ford Transit 2.2 TDCI

Engine Timing Tools > Ford Timing Tools

Applications:
Ford/Jaguar: 303-1310, 303-698, 303-732.
Ford: Transit (06-18), Ranger (11-18).
Jaguar: X-Type (05-10).
Land Rover: Defender (11-16).
Engine Codes:
2.2: QJBA, BG, ID4.
2.2 TDCi: CVFF, CVR5, CYFF, CYF5, CYR5, DRF5, DRFF, DRR5, GBVAJPF, GBVAJQJ, PGFA, PGFB, P8FA, P8FB, QVFA, QWFA, SRFA, SRFB, SRFC, SRFD, SRFE, UHFA, UHR5.
2.2D TDCi ECONetic: DRFC, DRFG, CYFC, CYFG.
2.2D TDCi HDT: UYR6, USR6.
3.2D TDCi: SAFA.



Art. 51008-WW

Ford Engine Timing Tool Set Tdci

Engine Timing Tools > Ford Timing Tools

This kit has been designed for setting and adjusting the timing on Ford models with 2.0 and 2.4 16v TDCi engines.

Applications: Mondeo, Transit (01-04) etc.
Engine codes: FMBA / B, D5BA, ABFA, D3FA, F3FA, D2FA, D4FA, F4FA.
This kit is especially needed when making chain changes, engine repairs and work on the injection pump.

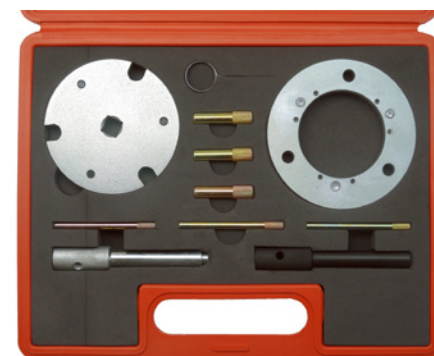

Art. 800010-UTC

Diesel Engine Timing Tool Set for Fiat, Ford, Opel, Suzuki 1.3 Diesel

Engine Timing Tools > Ford Timing Tools

Timing set suitable for Fiat, Opel/Vauxhall, Suzuki, Ford Ka 1.3 TDCI.

Counter holding tool for crankshaft pulley, to be used as Fiat Ford OEM 1871000200.

Ford OEM 303-1469 - Opel/Vauxhall OEM KM-662-C.

Crankshaft adjustment tool, to be used as Opel (Vauxhall) OEM EN 46785 OEM KM 955, Suzuki 09912-38300.

Camshaft adjustment tool, to be used as Fiat OEM 1871000900 / 1860985000 - Ford OEM 303-1472, Opel (Vauxhall) OEM EN 46781 - Suzuki OEM 09917-68610.

Chain tensioning lever, to be used as Fiat OEM 1870900400.

Crankshaft locking tool, to be used as Fiat OEM 1870900300 - Ford OEM 303-1468.
Camshaft adjustment tool, Fiat 8mm.



Art. 8051-WW

Engine Timing Tool Kit For Ford / Volvo 2.5 Turbo

Engine Timing Tools > Ford Timing Tools

Timing and camshaft locking tool for Euro 4 engines found in Ford and Volvo models. Enables crankshaft to be held in place while working on the centre pulley nut which can be exceptionally tight.

Suitable for HUBA, HUWA, HYDA engines. 2.5L.

Models:

Volvo: C30 (06-10), C70 (98-10), S40 (96-10), S60 (00-09), S70 (97-07), S80 (98-06), V40 (96-10), V50.

(04-10), V70 (97-07), XC70 (02-07), XC90 (02-10).

Ford: Focus, Mondeo, S-Max 2.5 ST, Galaxy 2.5 ST (2005-).

Diesel: 2.4D D5244T9, 2.4D5 D5244T8 D5244T13.

Petrol: 1.6 B4164S, 1.8 B4184S, 1.9T B4194T, 2.0 B4204S B4204T, 2.0T B5204T3 B5204T4 B5204T5, 2.3. B5234FS, 2.3T B5234T3 B5234T7 B5234T9, 2.4 B5244S B5244S2 B5244S4 B5244S5 B5244S7, 2.4T B5244T.



Art. 8056-WW

Engine Timing Tool Set For MINI / PSA Engines N12

Engine Timing Tools > BMW Mini Timing Tools

This kit is needed for replacing the cylinder head sealing and setting the timing.

Applications: MINI One, HB Cooper, Cooper, series R55-56 with engine code N12.

Citroen C4 (08-09), C4 Picasso (08-09).

Peugeot 207 (06-09), 207CC (07-09), 308 (01-09).

With engine: 1.4 VTi (Valvetronic), EP3 (8FS) (Valvetronic), EP6 (5FW), 1.6THP (Direct Injection), EP6DT (5FX), EP6DTS(5FY).

OEM Tools:

Crankshaft locking tool use as OEM 119590.

Camshaft locking tool use as OEM 119540.

Chain tensioner use as OEM 119340.

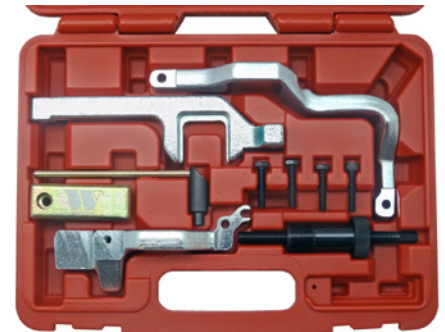

Art. 1109-WW

Engine Timing Tool Set BMW/Mini W16D

Engine Timing Tools > BMW Mini Timing Tools

This kit has been designed for setting the timing on W16D16UO engines.

Applications:

BMW MINI, Mini Clubman (07-10) on R55/56/57 models, engine with the codes W16D16 (9HZ) and W16D16UO.

CITROEN 1.6 diesel in C2, Xsara, Picasso, C4, C5, C4 Picasso, Grand Picasso and Berlingo.

Peugeot 1.6 diesel engine in 1007, 206, 207, 307, 308 and Partner.



Art. 1228-WW

Petrol Engine Timing Kit For BMW, Mini, Citroen, Peugeot Chain Driven

Engine Timing Tools > BMW Mini Timing Tools

OEM tools included: 11.3.340, 11.4.360, 11.5.140, 11.9.280, 11.9.330.

Applications:

BMW 1 Series: 116i E81/82/87/88 (04-09), 118i E81/82/87/88 (04-14), 120i.

E81/82/87/88 (04-14), 125i E82 (07-12), 130i

E81/87 (05-12), 135iS E82(07-12) BMW 3

Series: 316i/ti Compact.

E46 (01-07), 316i E90/91/92/93 (05-14), 318i/

ti Compact E46 (01-07), 318i E90/91/92/93

(05-12), 320i, E90/91/92/93 (05-12), 323i

E90/91/92/93 (04-11), 325i E90/91/92/93

(04-12), 330i E90/91/92/93 (04-14), 335i

E90/91/92/93 (04-14) BMW 5 Series: 520i

E60/61 (07-10), 523i E60/61 (04-10), 525i

E60/61 (04-10), 530i E60/61 (05-10)BMW 6

Series: 630i E63/64 (04-11) BMW 7 Series:

730i E65/66 (04-12) BMW X Series:

X1 sDrive 18i E84 (10-12), X1 xDrive 18i E84

(10-12), X3 2.0 E83 (05-10), X3 2.5/3.0 E83

(06-10), X5 3.0 E70.

(06-10) BMW Z Series: Z4 2.0 E85/86 (04-

09), Z4 2.5/3.0 E85/86 (05-09) BMW Mini:

Clubman (R55) (08-14), Cooper S R55/56 (06-

10), Cooper R55/56 (06-10), Mini One R56

(07-10) Mini (R56/57) (08-15).



Art. 4158-WW

Engine Timing Tool Set For VAG 2.4 & 3.2 FSI

Engine Timing Tools > Audi Timing Tools

For checking and adjusting the engine timing.
Suitable for Audi V6, V8 and V10 engines with chain.

Includes:

Camshaft locking tool.

To be used as OEM T40070- crankshaft locking pin.

To be used as OEM T40069.

Chain tensioner lock.



Art. 1170-WW

Engine Timing Tool Set For VAG 2.7 & 3.0 TDi

Engine Timing Tools > Audi Timing Tools

For locking the camshaft, crankshaft and fixing the chain tensioner.

Applications:

VW Touareg, Phaeton with engine codes:

ASB, BKN, BKS, BMK, BMZ, BNG, BPP, BSG, BUG, BUN, CAMA, CAMB, CANA, CANB, CANC, CAND, CAPA, CARA, CARB, CASA, CASB, CASC, CATA, CCMA, CCWA, CCWB, CDYA, CDYB, CDYC, CEXA, CGKA, CGKB.

OEM Tools:

camshaft locking pin to be used as OEM T40062.

Camshaft tool to be used as OEM T40061.

Rotating adapter for crankshaft: OEM T40049.

Locking pin for injection pump: OEM 3359.

Rotating adapter for crankshaft: OEM T40058.

Camshaft locking tool 2x: OEM T40060.

Crankshaft locking pin: OEM 3242.

Locking pin for chain tensioner 2x.

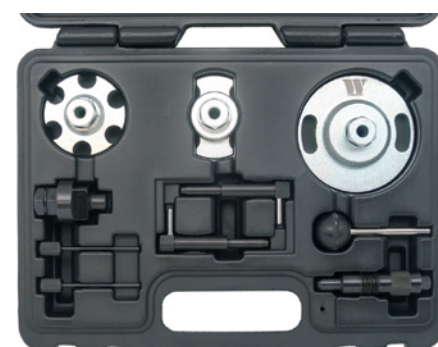

Art. 5002-WW

Timing Tool Set for Mercedes-Benz

Engine Timing Tools > Mercedes Benz Timing Tools

For setting and adjusting the timing on Mercedes Benz M651 engines e.g. Mercedes Benz 1.8/2.1 CDI diesel engines.

Applications: A-Class, C Class, CLA, E-Class, GLK, M-Class, S-Class, Sprinter, SLK, Viano and Vito.

Engine Applications: 180CDi, 200CDi, 220CDi, 250CDi, 210CDi, 310CDi, 510CDi, 213CDi, 313CDi, 216CDi, 316CDi 416CDi, 2.0CDi, 2.2CDi, 110CDi, 113CDi, 116CDi, 250 and 300 Blue TEC.

OEM Tools.

Camshaft Locking Tools (2) - 651 589 01 40 00.

Crankshaft Pulley Holding Tool - 651 589 00 40 00.



Art. 1227-WW

Timing Chain Guide For Mercedes Benz 651

Engine Timing Tools > Mercedes Benz Timing Tools

Includes:

Distribution chain tool.

Camshaft blocking holder.

Camshaft solvent key.

Crankshaft rotating device.

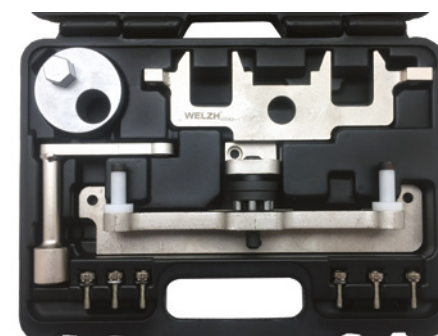

Art. 40063-WW

Engine Timing Tool Set for Mercedes M271

Engine Timing Tools > Mercedes Benz Timing Tools

Required when changing the timing chain.
 Suitable for following Mercedes-Benz models: CLK 200K (W209), C 180K, C200K, C 230K (W203), C Sportcoupe C 160K, C 180K, C 200K, C 230K, E 200K (W211), SLK 200K (R171), C 180K (W204), CLC 180K, CLC 200K, C 180 CGI, C 200CGI, C 250CGI (W204), E 200CGI, E 250CGI (W212, C207).
 Suitable for engines with the following engine codes: M271 E18ML (02-), DE18ML (03-05), E16ML (08-), DE18LA (09-).
 Holding device for timing chain, to be used as OEM 271589014000.
 Camshaft locking tool, to be used as OEM 271589006100.
 Locating pin, to be used as OEM 271589001500.
 Timing chain tool, to be used as OEM 271589003100.



Art. 4078-WW

Petrol Engine Setting-Locking Tool Set For Fiat, Ford, Lancia 1.2-1.4, 8v- Belt Drive

Engine Timing Tools > Fiat Timing Tools

For setting and adjusting the timing on Ford 1.2, 1.4L 8v engines.

Applications:

Fiat: 500 (07-12), Doblo/Cargo (05-10), Grande Punto (07-12), Idea (04-12), Linea (07-11), Panda EVO2, Punto EVO (09-12).
 Lancia: Ypsilon (06-11), Musa (05-12).
 Ford: Ka (09-12).

Engine Applications:

Fiat: 1.2/1.2 Dualogic, 169A4.000, 188A4.000 (EVO2), 199A4.000, 1.4/1.4 Bi-Fuel LPG / 1.4 Natural Power CNG, 199A7.000, 350A1.000.
 Lancia: 1.4/1.4 Bi-Fuel LPG, 350A1.000.
 Ford: 1.2 Duratec, 169A4.000 (FP4).
 OEM Tools.

Crankshaft Locking Tool: OEM 2.000.004.500 on Fiat/Lancia - OEM 303-1480 on Ford.

Camshaft Setting Tool to be used as OEM 2.000.004.400 on Fiat/Lancia and OEM 303-1479 on Ford.

Camshaft Sprocket Locking Tool to be used as OEM 2.000.004.200 on Fiat/Lancia and OEM 303-1477 on Ford.

Camshaft Cover Aligner to be used as OEM 2.000.004.300 on Fiat/Lancia and OEM 303-1478 on Ford.

Tensioner Adjuster to be used as OEM 1.860.987.000 on Fiat/Lancia.



Art. 4160-WW

Diesel Engine Setting/Locking Tool Kit - Land Rover & Jaguar TDV8 3.6 - Chain Drive

Engine Timing Tools > Land Rover Timing Tools

Setting and Locking kit for Range Rover L320 and L322 V8 3.6D.
 Kit includes a flywheel locking plate and camshaft rotating pin.



Art. 7028-WW

Engine Timing Tool Kit For Land Rover & Jaguar 2.0 GTDi

Engine Timing Tools > Land Rover Timing Tools

Set Includes:

Camshaft alignment tool (OEM 303-1600, 303-1565).
 Crankshaft pulley alignment tool set (OEM 303-1595).
 Crankshaft sensor alignment tool (OEM 303-1521).
 Flywheel holding tool (OEM 303-1594).
 Crankshaft setting pin (OEM 303-748).

Applications:

Jaguar XE, XF, XJ (13-16).
 Land Rover Discovery Sport (15-16).
 Land Rover Freelander 2 (12-15).
 Range Rover Evoque (11-16).



Art. 7080-WW

HAND TOOLS



38-Piece Brush Assortment Set

Brushes > Other Brushes

For cleaning and de-burring cylinders, bushings, pipes etc.
Nylon: Ø 8 - 9 - 10 - 11 - 12 - 13 - 14 - 15 - 16 - 17 - 18 - 19 mm.
1/4" drive brushes.



Art. 800044-UTC

Brush Assortment Set; 38 pcs

Brushes > Other Brushes

For polishing and cleaning machines, cars and other work pieces made of metal or plastic.
36 brushes: 8, 9, 10, 11, 12, 13, 14, 15, 16, 17, 18 and 19 mm diameter.
12x brass.
12x nylon.
12x stainless steel.
1/4" handle.
1 extender.



Art. 8007-WW

Wire Brush Set; 24pcs

Brushes > Other Brushes

Hardened and tempered crimped steel wire wheels.
6 x crimped wire brushes (2" and 4").
6 x cup wire brushes (2" and 3").
Suitable for use with air tools.



Art. 820-WW

24-Piece Wire Brush Set

Brushes > Other Brushes

Hardened and tempered crimped steel wire brushes.
Suitable for removing rust, paint etc. with ease.
Useful when working on body work.



Art. 831-WW

Wheel Hub Resurfacing Kit

Brushes > Other Brushes

Sanding pads conveniently attach with half turn thread.
Can be used for domestic and import vehicles with either front or rear disc brakes.
Kit comes complete with a holder and five sanding discs.
Nylon, silicon carbide, resin adhesive.
Polishing disc size: OD 40mm x thickness 14mm x ID 16mm.
Plastic tail socket size: 31.8mm.
Plastic tail socket thread M22.5, Bottom diameter 20.1x9mm.
Max operating speed: 15000rpm.
Connecting seat length: 74mm.
Connecting rod size: 6mm, length: 29mm.



Art. 7072-WW

TAP & DIE SETS

WRENCHES & EXTRACTORS



114-Piece Oil Sump Repair Kit

Cutting and Drilling > Tap and Die Sets

This comprehensive kit has been designed to repair damaged threads in the oil sump. Can also be used on gearboxes and differential drain plugs. Simply re-tap the thread and fit the corresponding sump plugs. The range of sizes in this set allows it to be used on most of the cars and LCV on the market today.
 Tap: M13 x 1.25, M13 x 1.5, M15 x 1.5, M17 x 1.5, M20 x 1.5, M22 x 1.5 (1 each).
 Plugs: M13 x 1.25, M13 x 1.5, M15 x 1.5, M17 x 1.5, M20 x 1.5, M22 x 1.5 (6 of each).
 Washers: 13, 15, 17, 20, 22 mm (various).



Art. 1015-1-WW

48pc Oil Repair Set

Cutting and Drilling > Tap and Die Sets

M15 x 1.5 HSS-G Screw Tap.
 10 Washers for M15.
 5x Screws (M15 x 1.5).
 M18 x 1.5 HSS-G Screw Tap.
 10 Washers for M18.
 5x Screws (M18 x 1.5).
 M20 x 1.5 HSS-G Screw Tap.
 10 Washers for M20.
 5x Screws (M20 x 1.5).



Art. 1015-WW

Oxygen Sensor Thread Repair Set

Cutting and Drilling > Tap and Die Sets

For the repair of broken oxygen sensor threads.
 No need to replace exhaust pipes.
 Included:
 Reamer Ø 18.6 mm for reaming of oxygen sensor threads.
 Tap M20 x 1.5 for cutting the repair bushing threads.
 Tap M18 x 1.5 for cutting of oxygen sensor threads.
 Insertion tool to insert the threaded bushings.
 5 repair bushings.



Art. 1098-WW

Wheel Hub Grinding Attachment

Cutting and Drilling > Tap and Die Sets

Designed specifically to clean the wheel and hub which is prone to corrosion and wear. With this one simple attachment the wheel/hub can be clean quickly and effectively. Designed with premium materials for longevity. Can improve the wheel balance; must have for any garage. Can be used to remove corrosion from any surface. Replacement pad available under 1401-1-WW.



Art. 1401-WW

40-Piece Tap & Die Set

Cutting and Drilling > Tap and Die Sets

Made from hardened carbon steel.

17 hand taps and 17 die stocks for:

Coarse thread: M3 x 0.6 mm - M4 x 0.75 mm - M5 x 0.9 mm - M6 x 1 mm - M7 x 1 mm - M8 x 1.25 mm - M10 x 1.5 mm - M12 x 1.75 mm.

Fine threads: M3 x 0.5 mm - M4 x 0.7 mm - M5 x 0.8 mm - M6 x 0.75 mm - M7 x 0.75 mm - M8 x 1 mm - M10 x 1.25 mm - M12 x 1.5 mm - 1/8" NPT27.

1 adjustable tap wrench.

2 die holders.

1 screw pitch gauge.

1 screwdriver slot SL.



Art. 800092-UTC

8-Piece Thread Repair Kit For Drive Shafts

Cutting and Drilling > Tap and Die Sets

Properly repair or renew damaged threads on axle spindles.

Rethreading dies are highly tempered for strength & durability and are 6-pt. shaped for use with a socket or wrench.

Rethreading tools are color-coded for quick visual identification.

Contents: M20X1.25, M20X1.5, M22X1, M22X1.5, M24X1.5, M24X2.0MM, 3/4" X20 UNEF, 13/16" X20.



Art. 1906-WW

14-Piece Brake Thread Repair Kit M12x1.5 For Vag Group

Brakes > Specialist Brake Service

Suitable for use on a range of VAG Group vehicles such as Audi, SEAT, Skoda and VW.

Included:

10 threaded inserts.

1 drill guide.

1 step drill.

1 tap.

Spare inserts available: 8117-1-WW.



Art. 8117-WW

Subframe Locating Pins For VAG Group

Brakes > Specialist Brake Service

Primary Used on a variety of Vag Model Vehicles Including Volkswagen Scirocco 09-. EOS (06), Golf (09), Golf Plus (05), Jetta (04-06), Polo (02), Fox (06), Passat (06), Passat CL (09) and Audi A3 (04), TT (07) and A4 (01). OEM Code: T10096. On some vehicles in the Volkswagen Audi Group the sub-frame needs to be removed to service the suspension bushes, when removing the clutch, changing the engine, servicing the wheels, steering, stabilizer bar or control arms. These pins are screwed into the sub-frame and used to guide it back into place once the task is complete. Care should be taken to bolt back diagonally and to the manufacturer's recommended torque. Two sizes are available: The first an M12 can be fitted to Volkswagen Scirocco (09), EOS (06), Golf (09), Golf Plus (05), Jetta (4-06) Polo (02), Fox (06), Passat (06), Passat CL (09), Audi A3 (04), TT (07) and A4 (01) - OEM T10096 (Sub-frame Locating Pins ? Volkswagen and Audi Group (Part No 4722)) The second size an M14 is primarily used for the new Volkswagen Crafter - OEM T10227 (Part No 4840)



Art. 7008-WW

Die Holder 38x14mm

Cutting and Drilling > Tap and Die Sets

Also available in set 1900-WW.



Art. 1900-DIEHOLDERLARGE-WW

Die Holder 25x9mm

Cutting and Drilling > Tap and Die Sets

Also available in set 1900-WW.



Art. 1900-DIEHOLDERSMALL-WW

Tap Wrench Holder M6-M20

Cutting and Drilling > Tap and Die Sets

Also available in set 1900-WW.



Art. 1900-TAPHOLDERLARGE-WW

Tap Wrench Holder M3-M12mm

Cutting and Drilling > Tap and Die Sets

Also available in set 1900-WW.



Art. 1900-TAPHOLDERSMALL-WW

Stud Cleaning and Grinding Kit for Wheel Hubs; 16pcs

Brakes > Specialist Brake Service

Clean stud faster and easier with this comprehensive kit.
Interchangeable heads.
Included brushes: 12, 13, 14, 16, 18, 22, 28 mm x 1.
3x 23 mm hub grinders.
2x 18 mm hub grinders.
1 x 1/2" adapter.
1 x hex brush.



Art. 1405-WW

110-Piece Metric & SAE Tap + Die Set

Cutting and Drilling > Tap and Die Sets

Designed for fine threads in particular.

Included:

Tungsten steel.

2 tap holders.

2 die holders.

1 T holder.

Each 35 taps and dies in following sizes / flank leads:

4-40UNC 6-32UNC 8-32UNC 10-24UNC 10-32UNF 12-24UNC 12-24UNC 1/4-28UNF 1/4-24UNS 1/4-32UNS 5/16-18UNC 5/16-24UNF 3/8-16UNC 3/8-24UNF 7/16-14UNC 7/16-20UNF 1/2-13UNC 1/2-20UNF 9/16-12UNC 9/16-18UNF 5/8-11UNC 5/8-18UNF 3/4-10UNC 3/4-16UNF M6X1,0 M8X1,25 M10X1,0 M11X1,5 M12X1,25 M12X1,75 M14X1,25 M18X1,5 1/8-27NP 1/4-18NPT.

Art. 1901-WW



45-Piece Tap + Die Set M6-M24

Cutting and Drilling > Tap and Die Sets

20 taps for internal threads and.

20 dies for external threads (one each size).

Pitch 0,75: M6.

Pitch 1,00: M8-M6.

Pitch 1,25: M8-M10.

Pitch 1,50: M10-M12-M14-M16-M18-M20-M22-M24.

Pitch 1,75: M12.

Pitch 2,00: M14-M16.

Pitch 2,50: M18-M20-M22.

Pitch 3,00: M24 each.

1 adjustable tap wrench.

1 T-type tap wrench.

1 die holder.

1 adaptor for die holder.

1 plain slotted screwdriver 6 mm.

Art. 1902-WW



110-Piece Metric Tap + Die Set M2-M18

Cutting and Drilling > Tap and Die Sets

Especially for fine threads.

Tungsten steel.

2 tap holders.

2 die holders.

1 T holder.

Sizes:

M2 x 0.4, M3 x 0.5, M4 x 0.7, M5 x 0.8, M6 x 1.0.

M6 x 0.75, M7 x 1.0, M7 x 0.75, M8 x 0.75, M8 x 1.0.

M8 x 1.25, M9 x 0.75, M9 x 1.0, M9 x 1.25, M10 x 0.75.

M10 x 1.0, M10 x 1.25, M10 x 1.5, M11 x 0.75, M11 x 1.0.

M11 x 1.25, M11 x 1.5, M12 x 0.75, M12 x 1.0, M12 x 1.25.

M12 x 1.5, M12 x 1.75, M14 x 1.0, M14 x 1.25, M14 x 1.5.

M14 x 2.0, M16 x 1.0, M16 x 1.5, M16 x 2.0, M18 x 1.5

Art. 1900-WW



30-Piece Metric Tap & Die Set M3-M12

Cutting and Drilling > Tap and Die Sets

21 Taps: M3, M4, M5, M6, M8, M10, M12.

7 Dies: M3, M4, M5, M6, M8, M10, M12.

1 Tap Wrench: 25mm O/D.

1 Screwdriver.

1 Screwdriver Pitch Gauge.

Art. 1905-WW



Wheel Stud Master Re-Threader Kit

Cutting and Drilling > Tap and Die Sets

This kit is for re-threading internal or external damaged wheel stud threads, also helps with the accurate alignment.



Art. 4096-WW

131-Piece Thread Repair Set

Cutting and Drilling > Tap and Die Sets

For repairing threaded holes.

Minimizes time and expenses.

The set includes the following tools:

5 drills for drilling out the broken thread.

5 insertion tools for mounting the spare inserts.

5 taps.

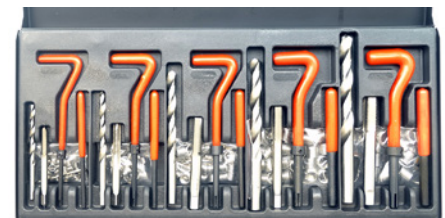

Art. 51001-WW

64-Piece Oil Plug Thread Repair Set

Cutting and Drilling > Tap and Die Sets

4 x Taps made from HSS (high speed steel) 4341: M13 x 1.5, M15 x 1.5, M17 x 1.5, M20 x 1.5.

20 x Oil drain plugs / sump plugs made from 45CR (4 sizes, 5 pcs for each).

40 x Aluminium washers / sealing rings (4 sizes, 10 pcs for each).



Art. 80008-UTC

Drill Bit Set; Fully Ground, 170 pcs

Cutting and Drilling > Drill Bits and Sets

Drills manufactured in accordance with DIN 338.

Roll forged.

Ground edges.

Sizes:

1.0-8.0 mm (in 0.5mm steps) : 10 piece each.

8.5-10.0 mm (in 0,5mm steps): 5 piece each



Art. 2008-WW

Drill Bit Set; Fully Ground, Left Hand Cutting, 5pcs

Cutting and Drilling > Drill Bits and Sets

Sizes: 3 - 5 - 6 - 8 - 10 mm.
Titanium coated.



Art. 2009-WW

Drill Bit Set; Fully Ground, Left Hand Cutting, 19pcs

Cutting and Drilling > Drill Bits and Sets

Left hand drill set is great for extracting broken or stripped screws, studs and bolts.
Sizes: 1, 1.5, 2, 2.5, 3, 3.5, 4, 4.5, 5, 5.5, 6, 6.5, 7, 7.5, 8, 8.5, 9, 9.5, 10 mm.
Made from high speed steel with Cobalt.
Long lasting working capacity.



Art. 2010-WW

Drill Bit Set; Cobalt, 19 pcs

Cutting and Drilling > Drill Bits and Sets

Sizes: 1, 1.5, 2, 2.5, 3, 3.5, 4, 4.5, 5, 5.5, 6, 6.5, 7, 7.5, 8, 8.5, 9, 9.5, 10 mm.
Advanced 118 degree Fully ground Split Point.
Short chisel edge for reduced drilling resistance.
Suitable for drilling in steel, cast iron, non-ferrous metals, alloyed & non-alloyed material.
Drill Bit Material: HSS 4241 Cobalt.
Long lasting working capacity.



Art. 2011-WW

Drill Bit Set; Fully Ground HSS, Titanium Coated; 230 pcs

Cutting and Drilling > Drill Bits and Sets

Fully ground from solid material (HSS) and titanium coated.
These drills are ideal for pairing alloyed & unalloyed steel with a tensile strength up to 800 N/mm², other metals, cast iron & hard plastics.
10 of each size: 1, 1.5, 2, 2.5, 3, 3.2, 3.5, 4, 4.2, 4.5, 5, 5.5, 6, 6.5, 7, 7.5, 8, 8.5, 10.
5 of each size: 9, 9.5, 10.5, 11, 11.5, 12, 12.5, 13.



Art. 2012-WW

Drill Bit Set; Fully Ground; Cobalt, 170 pcs

Cutting and Drilling > Drill Bits and Sets

Drill manufactured to DIN 338.
Ground from solid material.
1.0-8.0 mm ascending to 0.5mm: 10 pieces each.
8.5-10.0 mm ascending to 0.5mm: 5 pieces in metal box.
These drills are ideal for pairing alloyed & unalloyed steel with a tensile strength up to 800 N/mm², other metals, cast iron & hard plastics.



Art. 2013-WW

Drill Bit Set; Fully Ground; Cobalt, 25 pcs

Cutting and Drilling > Drill Bits and Sets

Sizes included: 1.0-1.5-2.0-2.5-3.0-3.5-4.0-4.5-5.0-5.5-6.0-6.5-7-7.5-8-8.5-9-9.5-10-10.5-11-11.5-12-12.5-13mm.
Advanced 118 degree Fully ground Split Point.
Short chisel edge for reduced drilling resistance.
Suitable for drilling in steel, cast iron, non-ferrous metals, alloyed & non-alloyed material.
Drill Bit Material: HSS 4241 Cobalt.
Long - lasting working capacity.



Art. 2014-WW

Drill Out Kit with Guides; Universal

Cutting and Drilling > Drill Bits and Sets

For use on cylinder heads, gearboxes, hubs etc.
Also compatible with motor cycle, cars and truck engines.
All drill bits are consumables.
Helps to reduce expensive damage to the engine by keeping the drill in the exact position each time.

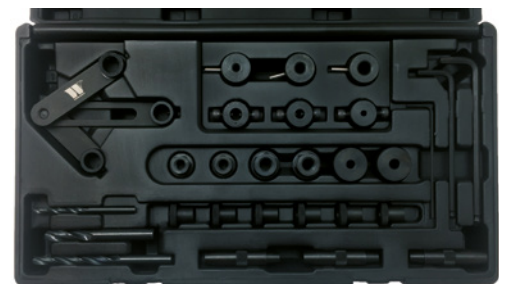

Art. 4085-WW

Step Drills; Titanium, 4-30mm

Cutting and Drilling > Drill Bits and Sets

Sizes: 4-12, 4-20, 4-30mm.
Drill steps in 2mm increments.
Long lasting HSS steel.



Art. 4098-WW

Replacement Disk 4mm Thickness

Cutting and Drilling > Cutting and Grinding Disks

4mm thick.
Max RPM: 20,000.



**CONSUMABLE
PRODUCT**
Not covered by warranty.

Art. 3015-1-WW

Replacement Disk 1mm Thickness

Cutting and Drilling > Cutting and Grinding Disks

Size: 58 x 1 x 10mm.
Max RPM: 27,000.



**CONSUMABLE
PRODUCT**
Not covered by warranty.

Art. 3015-2-WW

Flap Disk, Type 29, Aluminium Oxide 40 Grit Ø 115 mm (200 per Box)

Cutting and Drilling > Cutting and Grinding Disks

Size: 115 x 22.2 mm (4.5").
Flap disks are designed for grinding and blending.
Type 29.
Available in 40, 60 and 80 grit.



**CONSUMABLE
PRODUCT**
Not covered by warranty.

Art. 8396-WW

Flap Disk, Type 29, Aluminium Oxide 60 Grit Ø 115 mm (200 per Box)

Cutting and Drilling > Cutting and Grinding Disks

Size: 115 x 22.2 mm (4.5").
Flap disks are designed for grinding and blending.
Type 29.
Available in 40, 60 and 80 grit.



**CONSUMABLE
PRODUCT**
Not covered by warranty.

Art. 8397-WW

Flap Disk, Type 29, Aluminium Oxide 80 Grit Ø 115 mm (200 per Box)

Cutting and Drilling > Cutting and Grinding Disks

Size: 115 x 22.2 mm (4.5").
 Flap disks are designed for grinding and blending.
 Type 29.
 Available in 40, 60 and 80 grit.



**CONSUMABLE
 PRODUCT**
 Not covered by warranty.

Art. 8398-WW

Cutting Disk For Stainless Steel 230x 2.0 x 22.2 mm WerkConnect™ (100 per box)

Cutting and Drilling > Cutting and Grinding Disks

Size: 230 x 2.0 x 22.2 mm.
 Quantity: 100.
 MPA Approved.
 Not for grinding.



**CONSUMABLE
 PRODUCT**
 Not covered by warranty.

Art. 8400-WW

Cutting Disk For Stainless Steel 125x 1.0 x 22.2 mm WerkConnect™ (400 per box)

Cutting and Drilling > Cutting and Grinding Disks

Size: 125 x 1.0 x 22.2 mm.
 Quantity: 400.
 MPA Approved.
 Not for grinding.



**CONSUMABLE
 PRODUCT**
 Not covered by warranty.

Art. 8401-WW

Cutting Disk For Stainless Steel 115 x 1.0 x 2.2 mm WerkConnect™ (400 per box)

Cutting and Drilling > Cutting and Grinding Disks

Size: 115 x 1.0 x 2.2 mm.
 For use on stainless steel.
 Quantity: 400.
 MPA Approved.
 Not for grinding.



**CONSUMABLE
 PRODUCT**
 Not covered by warranty.

Art. 8935-WW

Cutting Disks 75x1.0mm x 9.5mm WerkConnect™ 600-Piece Extra Thin

Cutting and Drilling > Cutting and Grinding Disks

Size: 75 x 10 x 9.5 mm.
Quantity: 600.
Not for grinding.



Art. 8939-WW

Burrs; Carbide for Use with 3020-WW, 10pcs

Cutting and Drilling > Burrs

10-Piece Carbide Burrs

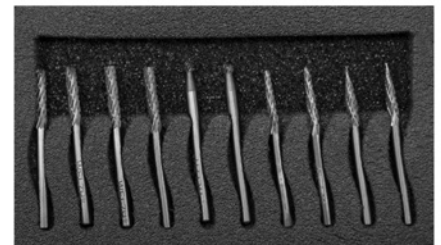

Art. 3020-1-WW

Burrs; Carbide, Short, 7pcs

Cutting and Drilling > Burrs

Suitable for drilling and milling machines.
For grinding and shaping Metal, aluminium, copper, etc.
Includes the following milling heads:
1 spherical.
2 conical.
2 cylindrical.
2 cylindrical with ball head.
Shaft diameter: 6mm.



Art. 78091-WW

Burrs; Carbide, Long, 7pcs

Cutting and Drilling > Burrs

Suitable for drilling and milling machines.
For grinding and shaping, Metal aluminium, copper, etc.
Includes the following milling heads:
1 spherical.
2 conical.
2 cylindrical.
2 cylindrical with ball head.
Shaft diameter: 6mm.



Art. 78092-WW



STOP! HAMMER TIME

SOFT SURFACE DEAD BLOW

Dead Blow Mallet With Fibre Glass Shaft 3.8kg

Hammers > Single Hammers

Plastic handle.
Blow-back proof due to steel balls in the head of the mallet, therefore stronger impact.
Especially for loosening stuck rims when changing tires.
Extra heavy duty for trucks and SUV.
Handle length: 780 mm.
Head Ø 105 mm.
Net weight 4500 g.



Art. 1605-WW

Dead Blow Hammer Set; 4-Piece

Hammers > Hammers sets

Piston hammer features an extended head that allows the hammer to pass the deck of the engine block for piston installation.
Piston hammer provides dead blow action and absorbs shock, reducing the chance of injury.
Complete range for a wide variety of Uses.
Soft face to stop damage to surfaces.
Includes:
7025-1-WW 1/2 lbs Dead Blow Hammer.
7025-2-WW 1 lbs Dead Blow Hammer.
7025-3-WW 2 lbs. Dead Blow Hammer.
7025-4-WW 32 oz. Piston Hammer.



Art. 7027-WW

Dead Blow Hammer; 1/2 lbs.

Hammers > Single Hammers

Provides dead blow force application and a flexible handle to absorb shock, reducing the chance of injury.
Soft face to stop damage to surfaces.
Available in set 7027-ww.



Art. 7027-1-WW

Dead Blow Hammer; 1 lbs.

Hammers > Single Hammers

Provides dead blow force application and a flexible handle to absorb shock, reducing the chance of injury.
Soft face to stop damage to surfaces.
Available in set 7027-ww.



Art. 7027-2-WW

Dead Blow Hammer; 2 lbs.

Hammers > Single Hammers

Provides dead blow force application and a flexible handle to absorb shock, reducing the chance of injury.
Soft face to stop damage to surfaces.
Available in set 7027-ww.



Art. 7027-3-WW

Piston Hammer; 32 oz.

Hammers > Single Hammers

Provides dead blow force application and a flexible handle to absorb shock, reducing the chance of injury.
Piston hammer features an extended head that allows the hammer to pass the deck of the engine block for piston installation.
Soft face to stop damage to surfaces.
Available in set 7027-ww.



Art. 7027-4-WW

Digital Vernier Caliper with Digital Display

Measuring > Calipers

Extra large display.
Scale in mm/inch, reading 1/100 mm.
Zero reset in any position.
Metric/inch conversion.
+ / - Display.
Incl. Battery.
Supplied in Plastic case.



Art. 60066-WW

Professional long Arm Riveter Set, 3.2-6.4 mm

Riveters > Riveters and Sets

Aluminium, steel and stainless steel rivets.
Suitable for rivet sizes 3.2 - 4.0 - 4.8 - 5.0 - 6.4 mm and for rivet nuts M4, M5, M6, M8, M10.
Includes draw bar for riveter M4, M5, M6, M8, M10.
Rivet stroke: max. 20 mm.
Handles can be folded.



Art. 7057-WW

Lazy Tong Riveter

Riveters > Riveters and Sets

Reduce fatigue and save time on repetitive tasks.
Durable heavy-duty construction.
Includes rivet adaptors.



Art. 7058-WW

Professional Hand Riveter

Riveters > Riveters and Sets

Suitable for rivets made of aluminium, copper and steel, diameters of 2.4, 3.2, 4.0, 4.8 mm.



Art. 7059-WW

Swivel Head Oil Filter Pliers

Pliers > Specialist Pliers

Specially designed jaws that swivel 180 degrees allows this tool to access oil and fuel filters in awkward and hard to reach areas.

Specifications:

Jaw swivel: 180 degrees.

Jaw range: 57 to 120 mm.

Long reach style.



Art. 1048-WW

CV Boot Pliers

Pliers > Specialist Pliers

Designed for installing the stainless steel hose clamps on CV boots.

To be used to apply the correct standard of torque found in the owners manual.

Torque can be adjusted by using a torque wrench on the 3/8" square.



Art. 1051-WW

Exhaust Hanger Remover

Pliers > Specialist Pliers

Facilitates removal of rubber hangers.

25° opening angle for easy operation.

Length: 285 mm.

Can be used on most vehicles offering the best solution to a tricky problem.



Art. 1066-WW

Flexi Head Fuel & Filter Pliers (commercial use)

Pliers > Specialist Pliers

Designed for use on fuel filters from 108 to 178 mm in diameter.

180 degree rotatable head for use in awkward areas.

Non-slip grips.

Heavy duty design.

Applications: LGVs, HGV's and larger vehicles.



Art. 1099-WW

Special Exhaust Clamp Pliers For PSA

Pliers > Specialist Pliers

For expanding of exhaust clamps when changing the exhaust pipe.
Suitable for: Citroen, Peugeot and Renault etc.
4 locking positions for easy working.
Opening width 20-60 mm.



Art. 1124-WW

Tire Valve Cutting Pliers

Pliers > Specialist Pliers

Designed for cutting the valve stem from the wheel.
Overall length: 230mm.
Max Open range: 18mm.



Art. 1193-WW

Magnetic Oil Drain Pliers

Pliers > Specialist Pliers

An excellent solution to a messy and awkward job.
The magnetic end allows the plug to be removed quickly and easily.
Reduce mess, spill and the risk of accidents.



Art. 1219-WW

Brake Spring Washer Pliers

Pliers > Specialist Pliers

The brake drum cover can cause problems when trying to remove the washer these plies solve that problem easily and quickly.
For removal and installation of the washer.



Art. 1220-WW

Brake Pipe Bending Pliers 3/16", 1/4", 5/16", 3/8"

Pliers > Specialist Pliers

Fast, accurate and simple bending of brake lines.
Can be used to bend up to 90 degrees.



Art. 4028-WW

Exhaust Pipe Clamp Removal Pliers

Pliers > Specialist Pliers

For use on PSA, Renault, Nissan and Opel/Vauxhall Vehicles.
Jaws: 50 mm.
Length 300 mm.
Give the ability to remove the clamp without removing the screw.
Handle has ratcheting function.



Art. 4095-WW

CV Boot Clamp Pliers 260mm

Pliers > Specialist Pliers

Applications: Earless clamps fitted to axle boots on Audi, BMW, Chrysler, Ford, GM, Honda, Mazda, Mercedes Benz, Nissan, Opel, Porsche, VAG.
Length: 260mm.
Dipped handles.
Spring loaded action.
Also suitable for thermoplastic axle boots.



Art. 5005-WW

Plastic Door Trim Pliers With Swivel Head

Pliers > Specialist Pliers

Easy release mechanism.
Will remove broken/unwanted trim clips.
Made from hardened steel.
Angle easily adjusted; 0-90°.



Art. 5013-WW

Fuel Line Pliers

Pliers > Specialist Pliers

For VW-Audi, Fiat, GM, Opel plus many more.
To be used in the removal and replacement of hose clips connections on in-line fuel filters.
Essential tool when changing the fuel filter unit and repairing the engine.



Art. 51002-WW

Door Trim Pliers

Pliers > Specialist Pliers

These special pliers have been designed to remove upholstery such as door panels.
The design of the tip allows easy access to all areas.
The spring loaded handle gives greater leverage.
Huge time saver.



Art. 780-WW

Pliers for Spark Plugs; Long Nose Type, 3pcs

Pliers > Specialist Pliers

Sizing: 280mm long.
Circle diameter: 12.5mm, 15mm, 19mm.



Art. 8014-WW

Drive Shaft Squeezing Pliers

Pliers > Specialist Pliers

Designed to pre-tension the drive shaft circlip during assembly of the outer constant velocity joint.
Suitable for: VW, Audi, Ford, Honda, Mazda, Mitsubishi, Nissan, Opel, SEAT, Skoda, Subaru, Suzuki, Toyota Etc.
By holding the driveshaft circlip with the 8022 the outer drive shaft splines can be easily assembled onto the CV joint.



Art. 8022-WW

Swivel Head Oil Filter Pliers

Pliers > Specialist Pliers

Specially designed jaws that swivel 180 degrees allows this tool to access oil and fuel filters in awkward and hard to reach areas.

Specifications:

Jaw swivel: 180 degrees.

Jaw range: 57 to 120 mm.

Long reach style.



Art. 805-UTC

Brake Line Bending Pliers

Pliers > Specialist Pliers

Designed to be used on brake systems especially when a 2handed tool wont fit.

Allows for sharp bends to be created quickly and easily.

Easy access to difficult places.



Art. 9102-WW

Space Saving Hose Clip Pliers

Pliers > Hose Clip and Clamp Pliers

Specifically made for space-saving hose clips.

Ratchet mechanism for holding hose clips open.

Suitable for most vehicles such as: Alfa Romeo, Citroen, Fiat, Ford, Hyundai, Lancia, Mercedes,

Opel, Peugeot, Porsche, Renault, Seat, Skoda, Toyota, Volvo, etc.

Especially suitable for new type hose clips on VAG fuel lines.



Art. 1139-WW

Hose Clamp Pliers Clic R Type

Pliers > Hose Clip and Clamp Pliers

Specially designed to work in awkward areas due to the unique swivel heads.

Can be used for removal or installation.

To be used in Clic and Clic-R type clamps.

Clic and Clic-R type clamps are found on the majority of modern vehicles.



Art. 1117-WW

3-Way Hose Clamp Compressor

Pliers > Hose Clip and Clamp Pliers

For compressing spring steel hose clamps.
Particularly useful in confined spaces.
Universal use for all vehicles.
Also usable on the new style VAG clips.



Art. 1161-1-WW

Hose Clamp Compressor 85mm

Pliers > Hose Clip and Clamp Pliers

For compressing steel spring hose clamps.
Particularly useful in confined and restricted spaces.
Universal use for all vehicles.
Can be operated either by hand or with 1/4dr hand ratchet.
Also usable on the new VAG clips.



Art. 1161-WW

Hose Clamp Compressor 60mm

Pliers > Hose Clip and Clamp Pliers

For compressing steel spring hose clamps.
Particularly useful in confined and restricted spaces.
Universal use for all vehicles.
Can be operated either by hand or with 1/4dr hand ratchet.
Also usable on the new VAG clips.



Art. 1162-WW

Angled Composite Hose Locking Pliers

Pliers > Hose Clip and Clamp Pliers

Designed to clamp rubber hoses such as brake, fuel and cooling lines.
30 degree angled heads.
Suitable for use on 10, 15 and 24 mm diameter hoses.
The angled heads allow the pliers to be sat parallel with the hoses saving space.



Art. 4005-WW

Multi-purpose Hose Clamp Pliers

Pliers > Hose Clip and Clamp Pliers

The multi-purpose function of these pliers comes from the specially designed. Head which allows it to be used on various applications. Locking mechanism.



Art. 4001-WW

Ergonomic Ratchet Pipe Clamps

Pliers > Hose Clip and Clamp Pliers

Designed to give a strong grip on hose lines whilst being quick to operate. Ratchet function with auto lock allows fast adjustment. Can be used on: hose pipes, brake pipes, fuel pipes etc.



Art. 4213-WW

Multi Direction Hose Clamp Pliers

Pliers > Hose Clip and Clamp Pliers

For VW and Audi fuel line clamps and for general radiator hose clamps. Intersected slots are ideal for multi-direction applications.



Art. 4044-WW

Flex-Clamp Pliers

Pliers > Hose Clip and Clamp Pliers

Allows for extra reach, removal & locking of clamps into an open position. Pliers can be locked, freeing up your hands which makes the job at hand easier. For hard to reach places the wire is flexible and can extend.



Art. 4081-WW

Hose Removal Pliers

Pliers > Hose Clip and Clamp Pliers

Easily disconnects hoses by gripping firmly the tubes/lines.
Jaw grooves for 3/16", 1/4" and 3/8" tubes and lines.
Especially suitable for hoses connected to tubes or lines with smooth surface, where exercising pushing force is not possible.
Pointed jaw tip allows access to confined spaces.
Special locking design enhances secure gripping.



Art. 4097-WW

Universal Hose Clamp Pliers

Pliers > Hose Clip and Clamp Pliers

Hose remover pliers.
Total length: 312mm.
Made in cr-mo steel with a black surface finish.
Dipping handle.



Art. 5014-WW

Flexible Hose Clamp Pliers

Pliers > Hose Clip and Clamp Pliers

Designed for removal and locking of clamps in the open position.
Can be used on plastic, metal self-tightening hose clamps with diameters of 18 to 54 mm.
Cable is designed for hard to reach areas and has a 360 degree swivel.



Art. 60021-WW

Hose Clip Pliers; Long Reach, Interchangeable Heads

Pliers > Hose Clip and Clamp Pliers

Professional quality hose clip pliers with interchangeable heads.
Long reach bowden cables.
670 mm cable for standard hose clamps.
Range: 3-52mm.
635 mm cable for Clip-R type hose clamps.
Range: 0-24 mm.
670 mm cable for patented dual side clamps for spring type and truck hose clamps.
Lockable with quick release.



Art. 1400-WW

Flexible Hose Clamp Pliers Clip Type

Pliers > Hose Clip and Clamp Pliers

Flexible hose clamp pliers.
Long reach thanks to the cable.
For replacing fuel oil and water hose clips.
Ideal for confined spaces.
Hose clamp range: 18-54mm.
630mm wire flex.



Art. 60022-WW

2pc Hose Clamp Set

Pliers > Hose Clip and Clamp Pliers

Ideal for clamping any kind of smaller hose.



Art. 60068-WW

9-Piece Hose Clamp Pliers Kit

Pliers > Hose Clip and Clamp Pliers

A comprehensive set of hose clamp tools all with vinyl coated handles.
Remote Action Hose Clip Tool.
Swivel Jaw Spring Wire Clip Pliers.
Angled Band Clip Pliers.
Flat Band Clip Pliers.
Clic-R Type Pliers.
Hose Removal Pliers.



Art. 7009-WW

Click-R Collar Pliers

Pliers > Hose Clip and Clamp Pliers

Used to release and reset reusable hose clips.
Designed for releasing and resetting clic & clic-R type metal hose clips fitted to most engines.
Spring loaded forged handles with PVC handles.



Art. 7019-WW

Hose Clamp Pliers 3-Piece

Pliers > Hose Clip and Clamp Pliers

For straight forward clamping of flexible hose pipes adjustable locking ring with locking function for complete stopping of the flow the hose is squeezed against the stable surface over a wide area, thus avoiding damage to the hose.
Ideal for maintenance work with petrol, oil, water and anti-freeze protects against leakage of petrol, oil, water and antifreeze ideally suited for cars, vans, MPVs, commercial vehicles, tractors, agricultural, construction and industrial uses.
Temperature resistance of up to 160 °C.
Hose clamp pliers, 155 mm, suitable for a hose diameter of 3 - 15 mm.
Hose clamp pliers, 185 mm, suitable for a hose diameter of 6 - 20 mm.
Hose clamp pliers, 255 mm, suitable for a hose diameter of 8 - 45 mm.



Art. 7077-WW

Professional Long Reach Hose Clamp Pliers With Cable

Pliers > Hose Clip and Clamp Pliers

Allows for the easy removal of hard to reach hose clamps.



Art. 800040-UTC

Long Reach Hose Clamp Pliers For Turbo Pipes On VAG Group

Pliers > Hose Clip and Clamp Pliers

Bowden cable allows for use in awkward areas.
Can be used on clamps from 18 to 54 mm.
Locking function.
640 mm reach.
Especially useful for Audi models.



Art. 800042-UTC

Long Reach Hose Clamp Pliers

Pliers > Hose Clip and Clamp Pliers

Designed for removing fuel, oil and water pipe clamps.
Flex length: 630 mm.
Perfect for use in awkward and confined areas.



Art. 800043-UTC



4-Piece Circlip Pliers Set, 175mm

Pliers > Circlip Pliers

Chrome plated.
Straight and bent tips.
For internal and external circlips.
Non-slip cushion grip handles.
Pliers tip \varnothing 2.0 mm.
Max opening:
External circlip pliers (angled) 30 mm.
External circlip pliers (straight) 39 mm.
Internal circlip pliers (angled) 35 mm.
Internal circlip pliers (straight) 38 mm.
Packed in a solid vinyl wallet.
41111-1-WW: Circlip Pliers; External Angled 175mm.
41111-2-WW: Circlip Pliers; External Straight 175mm.
41111-3-WW: Circlip Pliers; Internal Angled 175mm.
41111-4-WW: Circlip Pliers; Internal Straight 175mm.

Art. 41111-WW



4-Piece Circlip Pliers Set, 150mm

Pliers > Circlip Pliers

Straight and bent tips.
For internal and external circlips.
Non-slip cushion grip handles.
Pliers tip \varnothing 1.5 mm.
Max. Opening:
External circlip pliers (angled) 36 mm.
External circlip pliers (straight) 39 mm.
Available Separately:
41112-1-WW: Circlip Pliers; External Straight 150mm.
41112-2-WW: Circlip Pliers; External Angled 150mm.
41112-3-WW: Circlip Pliers; Internal Straight 150mm.
41112-4-WW: Circlip Pliers; Internal Angled 150mm.

Art. 41112-WW



4-Piece Circlip Pliers Set, 225mm

Pliers > Circlip Pliers

Straight and bent tips.
For internal and external circlips.
Non-slip cushion grip handles.
Pliers tip \varnothing 2.4 mm.
Max. opening:
External circlip pliers (angled) 36 mm.
External circlip pliers (straight) 39 mm.
Available separately:
41113-1-WW: Circlip Pliers; Internal Straight 225mm.
41113-2-WW: Circlip Pliers; Internal Angled 225mm.
41113-3-WW: Circlip Pliers; External Straight 225mm.
41113-4-WW: Circlip Pliers; External Angled 225mm.

Art. 41113-WW

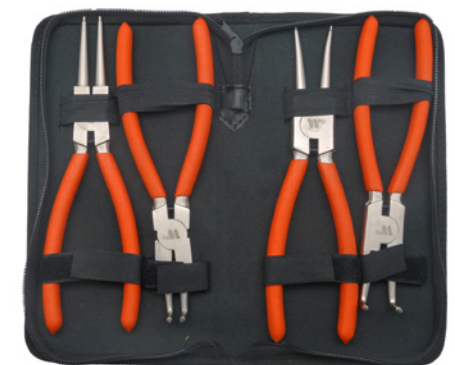

4-Piece Circlip Pliers Set, 300mm

Pliers > Circlip Pliers

Straight and bent tips.
For internal and external cir-clips.
Non-slip cushion grip handles.
Pliers tip \varnothing 3.2 mm.
Max. opening:
External circlip pliers (angled) 39 mm.
External circlip pliers (straight) 48 mm.
Internal circlip pliers (angled) 59 mm.
Internal circlip pliers (straight) 68 mm.
Packed in a solid vinyl wallet.

Art. 41114-WW



12-Piece circlip pliers set

Pliers > Circlip Pliers

Set of 12 circlip pliers in four different sizes (1, 1.2, 1.8 & 2.3 mm) each with three different angled tips: 0°, 45° & 90°.



Art. 1079-WW

6-Piece Circlip Pliers Set -130mm-160mm-230-mm

Pliers > Circlip Pliers

Included:
 Straight: 130, 160, 130 mm.
 Bent: 130, 160, 230 mm.



Art. 41115-WW

Circlip Pliers 90-Degree Internal

Pliers > Circlip Pliers

Designed for internal clips.
 Dip insulated handle.
 Tip length: 65 mm.
 Self-opening.



Art. 41116-WW

Pliers For Locking Rings

Pliers > Lock Ring Pliers

The special design of the pliers "Tips" enable the easy removal and replacement of wheel bearing cir clips that are without eyelets.
 Professional and safe removal and replacement of the wheel bearing-cir-clips are almost impossible without this special tool.
 Suitable e.g. for wheel bearing clips on; Citroen , Renault, Peugeot, Nissan, Citroen Xara, Renault Clio, Nissan Micra etc.



Art. 1149-WW

Lock Ring Pliers Set 90, 30, + Straight Tipped

Pliers > Lock Ring Pliers

Sizes included are: 30°, 60° and straight tipped.

For the removal of locking rings on brakes, clutch shafts, transmissions, master cylinders.



Art. 4170-WW

VAG Cigarette Lighter Release Tool

Pliers > Lock Ring Pliers

Used from removing the 12v socket (Cigarette lighter)

Applications

Audi A4 2001, Audi A4 2008, Audi Q5 2008, Audi A6 2005, Audi Q7 2007



Art. 8021-WW

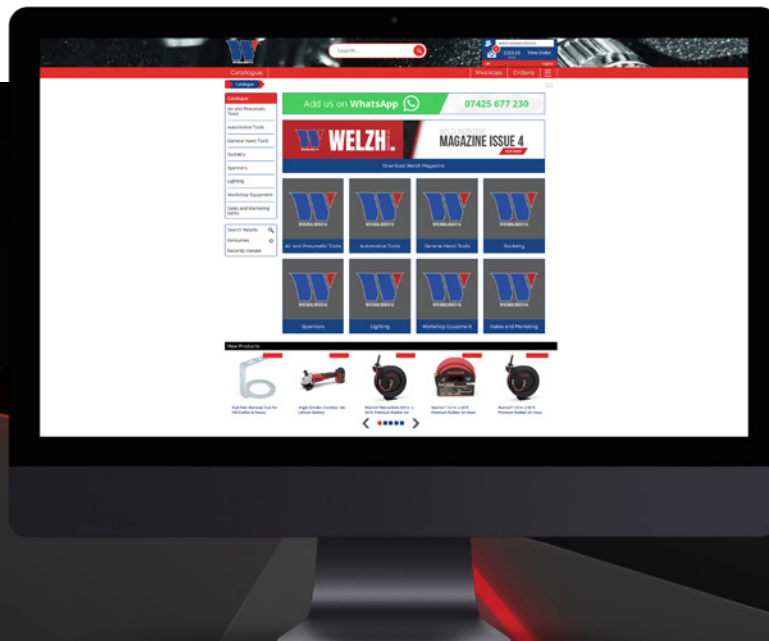

ONLINE B2B

WWW.WELCH.COM

Locking Ring Tool

Pliers > Lock Ring Pliers

Designed to install wheel bearing locking rings with ease.
Can be used on cars, LCVs and HGV.
Quick ratchet function allows for more torque to remove the rings easily.



Art. 5007-WW

4-Piece Locking Grip Pliers Set

Pliers > Lock Ring Pliers

Contact pressure continuously adjustable.
Long nose pliers length: 125mm, 150mm, 180mm, 250mm.



Art. 60052-WW

5-Piece Locking Grip Pliers Set

Pliers > Lock Ring Pliers

10" curved 10" straight 9" long nose 7" curved 6" long nose.



Art. 800033-UTC

Parrot Nose Locking Pliers

Pliers > Lock Ring Pliers

High quality Chrome Molybdenum alloy steel.
Professionally heat treated and machined.
Robust jaws engineered to clamp on screws, especially on round ones.
Ideal for clamping tie rod ends.
Nickel plated finish.



Art. 3102-WW

16-Piece Vice Grip Pliers Set

Pliers > Water Pump Pliers

3 round nose locking pliers, 185 x 55mm.
5 round nose locking pliers, 235 x 65 mm.
2 welding locking pliers 235 x 65 mm.
2 round nose locking pliers, 135 x 45mm.
2 welding clamp locking pliers 280 x 140 mm.
1 medium locking pliers.
1 small locking pliers.



Art. 2001-WW

Heavy Duty Water Pump Pliers 20" Inch

Pliers > Water Pump Pliers

Specification:
Length: 500mm / 20 inches.
Minimum opening: 20mm.
Maximum opening: 140mm.



Art. 800003-UTC

3-Piece Water Pump Pliers With Locking Function

Pliers > Water Pump Pliers

Included:
180 mm (7inch).
240 mm (10inch).
300 mm (12inch).
All adjustable with click and lock function.



Art. 800063-UTC

Pliers for Water Pumps; 20"

Pliers > Water Pump Pliers

Specification:
Length: 500mm / 20 inches.
Minimum opening: 20mm.
Maximum opening: 140mm.



Art. 8008-WW

4-Piece Water Pump Pliers Set

Pliers > Water Pump Pliers

Professional quality.
High quality lacquered black finish.
Forged and hardened.
Polished jaws and joints.
PVC dipped handles.
Includes 4 different pliers sizes:
175 mm / 27 mm opening.
240 mm / 38 mm opening.
300 mm / 44 mm opening.
400 mm / 80 mm opening.



Art. 1324-WW

Pliers for Water Pumps; 16" (Heavy Duty)

Pliers > Water Pump Pliers

Length: 400mm / 16".
Heat treated carbon steel.
Comfortable non slip grip handles.
Deep grooves for better grip.



Art. 8018-WW

3-Piece Pliers Set

Pliers > Pliers Sets

6" long nose pliers.
6" side cutting pliers.
7" combination pliers.
Coated handles for extra grip.



Art. 558-WW

Ignition Coil Puller Tool - VAG

Pliers > Pliers Sets

Designed for dismantling of ignition coils, which are mounted directly on the spark plug.
Applications
VW Golf from 2013, Audi A3 from 2013, SEAT Leon from 2013, Skoda Octavia from 2013 fitted with 1.2, 1.4 and 2.0L FSI chain engines.



Art. 4032-WW

5 Piece Long Nose Pliers Set

Pliers > Long Nose Pliers

5 piece set with 0, 20, 45, 90, 45 degree offset tips.
Handle: 2k non slip.
290 mm long.



Art. 781-WW

3-Piece High Leverage Pliers

Pliers > Long Nose Pliers

-Precision forged jaws for positive stamping.
Hardened, tempered cutting edges.
Bonus side cutter feature on each pair offers 40-50 percent more gripping and cutting power.
Long reach shaft enables easy usage in recessed areas.
Cushioned grip hand.



Art. 800018-UTC

3-Piece X-Type Pliers

Pliers > Long Nose Pliers

Perfect for hard to reach jobs.
X type style means better control.
Set includes 12" long, flat and offset pliers.



Art. 800020-UTC

3-Piece Needles Nose Pliers Set 225mm

Pliers > Long Nose Pliers

Manufactured from drop forged, heat treated steel.
Fully polished finish.
Superb for use in areas with limited access.
Non-slip foam cushion-grip handles.
Content:
Straight nose pliers.
45° angle nose pliers.
90° angle nose pliers.



Art. 800068-UTC

Pliers; Long Nose, Double Joint, 3pcs

Pliers > Long Nose Pliers

All jaws and cutting edges are heat-treated to provide consistent performance.
Forged alloy steel with brushed finish delivers durability.
All non-brushed surfaces are coated to prevent rusting.
Dipped, chemical-resistant handles provide added comfort and grip.
All pliers exceed ANSI and ASME standards.



Art. 815-WW

Warranty Repairs & Replacements Available Online...

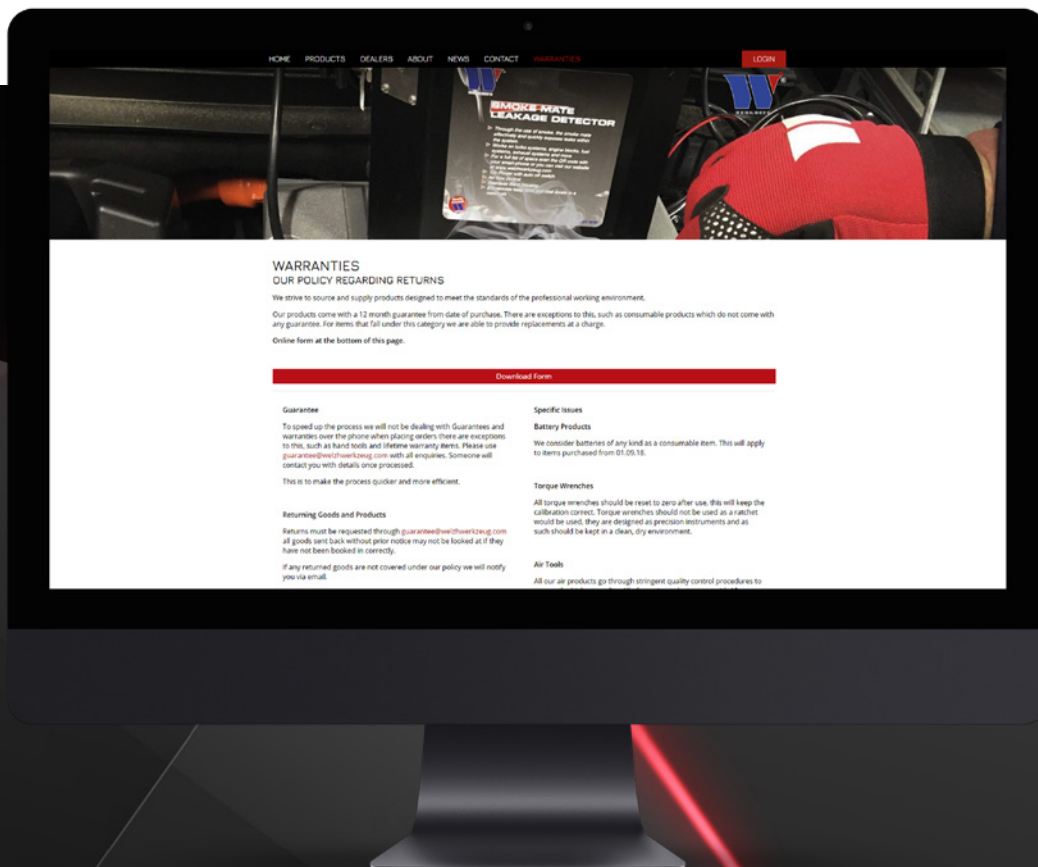

**WARRANTY
& REPAIRS**
WELZH.COM/WARRANTIES

Side Cutters; Double Joint, Long Nose, 290 mm

Pliers > Cutting Pliers

The special design of the double joint allows for extra leverage which works well in difficult areas.



Art. 815-1-WW

Automotive Crimping Tool Set with 5 Pairs of Jaws

Pliers > Crimping Pliers

Crimping tool set with ratcheting function and adjustable jaws.
Includes 5 exchangeable crimping jaws for:
Die for Heat Shrink Butt Connector (0.5-10mm²).
Die for Fully Insulated Quick Disconnect (0.5-6mm²).
Die for Miniature Insulated Terminal (0.1-1.5mm²).
Die for Insulated Flag Terminal (0.5-2.5mm²).
Die for Closed End Connector & Heat Shrink Terminal (0.5-6mm²).
Quick Change Ratchet Crimper.



Art. 60045-WW

Supaseal Ratchet Crimping Pliers

Pliers > Crimping Pliers

For Use With Supaseal Connectors.
Soft Rubber Grip Handles.
Quick Release Jaws.
Crimping Range 0.35 to 1.5 mm² / 22 to 16AW.



Art. 60053-WW

3-Piece Diagonal Cutting Pliers Set

Pliers > Cutting Pliers

Coated handles.
Supplied with storage wallet.



Art. 800034-UTC

Ratchet Crimping Tool 0.5-6 mm² (For None Insulated)

Pliers > Crimping Pliers

For not insulated terminals.
Sizes: 0.5, 1, 1.5, 2, 5, 4, 6 mm².
Length: 215 mm.



Art. 880-WW

Ratchet Crimping Tool, 0.5 - 6 mm² (For Insulated)

Pliers > Crimping Pliers

Insulated handles.
For insulated terminals.
0.5 - 1.5 / 1.5 - 2.5 / 4 - 6 mm².
Length: 215 mm.



Art. 881-WW

36 Inch Heavy Duty Pry Bar

Pry Bars, Picks and Pick Up Tools > Pry Bars

Straight tipped.
Heavy duty.
File function on handle.
Anti-slip handle.



Art. 1043-WW

36 Inch Angled Heavy Duty Pry Bar

Pry Bars, Picks and Pick Up Tools > Pry Bars

Angled head.
Heavy duty.
File function on handle.
Anti-slip handle.



Art. 1044-WW

4pc Heavy Duty Pry Bar Set

Pry Bars, Picks and Pick Up Tools > Pry Bars

Sizes: 200x10 - 300x15 - 450x18 - 600x18 mm.
Slip guard handles with steel head.
Go through handles.
File function on the handles.
Perfect for everyday workshop use.



Art. 1046-WW

Heavy Duty Pry Bar 8" Inch

Pry Bars, Picks and Pick Up Tools > Pry Bars

Capped handle end provides a solid striking point for use with hammers.
Increased tip width for maximum contact.
Non-slip handle to improve leverage.
Impact cap & go-through blade.



8" Art. 1046-1-WW

12" Art. 1046-2-WW

18" Art. 1046-3-WW

24" Art. 1046-4-WW

Pry Bar Set; 4-Piece Heavy Duty 2x900mm & 2x600mm

Pry Bars, Picks and Pick Up Tools > Pry Bars

Manufactured from 16 mm square Chrome Molybdenum steel.
Extra-heavy-duty prybar set with textured handles.
Set comprises: 900mm/Straight, 900mm/25°, 600mm/75°, 600mm/90°.
Supplied in carry-case.



Art. 800091-UTC

Tire Lever with Polymer Protector; 535 mm

Pry Bars, Picks and Pick Up Tools > Pry Bars

Effective tool for mounting and dismounting tires on aluminium and steel wheels.
The polymer protector prevents damage to the rim when used correctly.
Not suitable for powder coated or painted rims.
Length: 535 mm.



Art. 1402-WW

Extendable Pry Bar With Rotating Head 63-94 MM

Pry Bars, Picks and Pick Up Tools > Pry Bars

Telescopic.
Length: 24 to 36 inches.
Adjustable, lockable head.
10 locking positions up to 48".
Heavy duty construction.



Art. 1082-WW

Extendable Pry Bar With Rotating Head 34-47 MM

Pry Bars, Picks and Pick Up Tools > Pry Bars

Chrome vanadium steel hardened & tempered with curved foot.
Foot has 180 movement with 14 locking positions for improved access & leverage over conventional bars.



Art. 4072-WW

Extendable Pry Bar With Rotating Head 86.5-135 MM

Pry Bars, Picks and Pick Up Tools > Pry Bars

Chrome vanadium steel hardened & tempered with curved foot.
Foot has 180 movement with 14 locking positions for improved access & leverage over conventional bars.



Art. 4073-WW

Pry Bar Set; 4pcs

Pry Bars, Picks and Pick Up Tools > Pry Bars

Sizes: 200x10 - 300x15 - 450x18 - 600x18 mm.
Anti-slip guard handles with steel head.



Art. 78906-WW



36 Inch Angled Pry Bar

Pry Bars, Picks and Pick Up Tools > Pry Bars

Angled head.
Heavy duty.
File function on handle.
Anti-slip handle.



Art. 80062-UTC

Flexible Magnetic Pick Up Tool

Pry Bars, Picks and Pick Up Tools > Pick Up Tools

Flexible shaft designed for easy access to awkward areas.
Perfect to extracting lost bolts and nuts for internal engine parts.
Magnetic tip.



Art. 30890-WW

Bendable Magnetic Pick Up Tool

Pry Bars, Picks and Pick Up Tools > Pick Up Tools

Mini flexible magnetic pickup tool is ideal for reach for removing broken debris from glow plug apertures and hard to reach spaces. Flexible shaft can be formed into versatile shapes and retain its shape to suit a wide range of applications.

Tip Diameter: 4mm.
Cable Length: 400mm.
Handle Length: 80mm.



Art. 2439-WW

Magnetic Pick Up Pen

Pry Bars, Picks and Pick Up Tools > Pick Up Tools

Heavy duty magnetic tip.
Capacity: 8lb.
Extendable to 24".
Comfort non slip grip.



Art. 30893-WW

3-piece LED Tweezers Set

Pry Bars, Picks and Pick Up Tools > Pick Up Tools

Particularly useful in poorly lit work areas, e.g. instrument panels.
Equipped with especially bright LEDs.
Battery: LR41 button cell- length: 150 mm.



Art. 5003-WW

Telescopic Magnetic Pick Up Tool - 5-Pieces

Pry Bars, Picks and Pick Up Tools > Pick Up Tools

Length: 5.9" to 24".
1.5lbs Lift.
Pocket clip.



Art. 500-WW

Telescopic Magnetic Pick Up Tool

Pry Bars, Picks and Pick Up Tools > Pick Up Tools

Length: 5.9" to 24".
1.5lbs Lift.
Pocket clip.



Art. 501-WW

Flash Light With Magnetic Pick Up Tool

Pry Bars, Picks and Pick Up Tools > Pick Up Tools

170 to 545 mm extendable telescopic magnetic lifter with flexible gooseneck for lifting metal objects like screws, tools, coins etc.3 energy-efficient, durable and bright LED.
Aluminium housing with mounting clip.
Magnetic holding force 1 kg.
Diameter 25 mm.
Includes 4 LR44 batteries.



Art. 789-WW

10-LB Magnetic Pick Up Tools

Pry Bars, Picks and Pick Up Tools > Pick Up Tools

10 LB magnetic pen.
Telescopic.
Coated handle.



Art. 8015-WW

Magnetic Pick-up Tool - 2.5 lb, Claw, Magnet, Light

Pry Bars, Picks and Pick Up Tools > Pick Up Tools

2.5 lb capacity.
4 prong claw.
LED light at the tip for easy visibility in dark areas.



Art. 804-UTC

5-Piece Extra Long Pick Set

Pry Bars, Picks and Pick Up Tools > Pick and Hooks

Assortment of 5 different picks to suit a wide range of applications.
Non-slip handle.
Extra long.



Art. 60050-WW

Pick Set; Mini Type, 4pcs

Pry Bars, Picks and Pick Up Tools > Pick and Hooks

Used for getting small parts from tight spaces.
Including removal of O-rings & gaskets.
Straight pick, hook angled 90°, round hook, angled hook.



Art. 875-WW

Pick and Hook Set; Extra Long, 10pcs

Pry Bars, Picks and Pick Up Tools > Pick and Hooks

Sizes Included: 4x 7.7cm & 6x 15.2cm.
 2 x hook.
 3 x small angle hook.
 3 x 90° hook.
 2 x straight picks.
 With 'O' rings.



Art. 876-WW

Pick and Hook Set; 6pcs

Pry Bars, Picks and Pick Up Tools > Pick and Hooks

Made from stainless steel.
 Straight tip with a 90° bent tip for o-rings.
 Hook tip/Combination tip.
 Sizing: Length 135mm.



Art. 877-WW

Pick and Hook Set w/ Scraper; 9pcs

Pry Bars, Picks and Pick Up Tools > Pick and Hooks

Included.
 Small straight pick.
 Small full hook.
 Small 45° hook.
 Small 90° hook.
 Large 1" scraper.
 Large straight pick.
 Large full hook.
 Large 45° hook.
 Large 90° hook.
 Easily gain access to tricky and awkward areas.



Art. 878-WW

12-Piece Needle Precision File Set

Pry Bars, Picks and Pick Up Tools > Files

High cutting rate.
 With solid plastic handle.
 For precision Work.



Art. 60067-WW

File Set; 5pcs

Pry Bars, Picks and Pick Up Tools > Files

Included:

Flat files: 250 mm, H1 coarse / 200 mm, H2 medium fine.

Half round file: 200 mm, H1 coarse.

Triangular file: 150 mm, H2 medium fine.

Round file, 150 mm, H1 coarse.



Art. 78904-WW

28-Piece Heavy Duty Punch & Chisels

Punch and Chisels > Punches

5 pin punches: 2.4 x 110 mm, 3.2 x 120 mm, 4 x 125 mm, 5 x 135 mm, 6.5 x 145 mm.

5 tapered punches: 2.4 x 135 mm, 3.2 x 145 mm, 4 x 150 mm, 5 x 160 mm, 6.5 x 170 mm.

3 cold chisel: 9.5 x 140 mm, 12.5 x 150 mm, 16 x 165 mm.

2 centre punches: 3 x 125 mm, 4.8 x 150 mm.

6 cold chisel: 12.5 x 170 mm, 5 x 180 mm, 19 x 200 mm, 18 x 200 mm, 22 x 250 mm, 25 x 250 mm.

4 cold chisel: 3 x 150 mm, 18 x 260 mm, 9.5 x 125 mm, 9.5 x 250 mm.

2 centre punches made from high carbon steel 145 mm and 375 mm.

1 chisel punch gauge.



Art. 1650-WW

18-Piece Professional Punch Set

Punch and Chisels > Punches

Extra long and thin.

Includes following 18 punches.

8x pin punches, 200 mm length: 1.5 - 2.5 - 3.0 - 4.0 - 5.0 - 6.0 - 8.0 - 9.5 mm.

2x pin punches, 150 mm length: 8.0 - 9.5 mm.



Art. 800026-UTC

Knife; Folding with Clip, inc. Blades

Cutting and Drilling > Knives

Folding knife with included blades.



Art. 879-WW

Screwdriver Set; L-Handle, 2-10 mm, S2

Screwdrivers and Key Sets > Screwdrivers

Sizes: 2x90, 2.5x100, 3x115, 4x120, 5x140, 6x160, 8x175, 10x200.
Made from S2 steel which is hardened to prevent breaking.
Double sided use.
Coated handles.

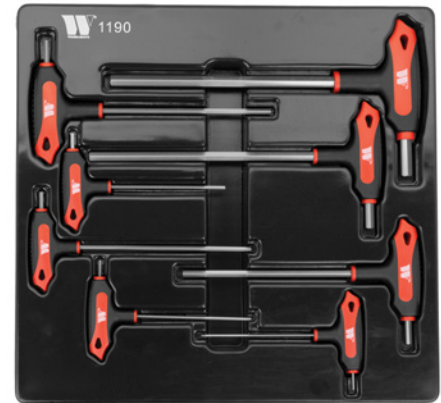

Art. 1190-WW

7-Piece L-Handle Tamper Torx & Torx Set T10-T40 S2

Screwdrivers and Key Sets > Key Sets

Sizes:
T10x100, T15x115, T20x120, T25x130, T27x140, T30x150.
Double sided use.
Made from S2 steel which is hardened to prevent breaking.
Coated handles.



Art. 1191-WW

8-Piece T-Handle Hex Key Set

Screwdrivers and Key Sets > Key Sets

Sizes: T10x100, T15x115, T20x120, T25x130, T27x140, T30x150.
Double sided use.
Made from S2 steel which is hardened to prevent breaking.
Coated handles.



Art. 5016-WW

7-Piece T-Handle Torx key Set

Screwdrivers and Key Sets > Key Sets

Sizes: 2x90, 2.5x100, 3x115, 4x120, 5x140, 6x160, 8x175, 10x200.
Double sided use.
Made from S2 steel which is hardened to prevent breaking.
Coated handles.



Art. 5017-WW

Screwdriver Set; Diamond Tipped, Extra Long (10pcs)

Screwdrivers and Key Sets > Screwdrivers

Magnetic Diamond tipped slotted and Phillips heads.

Sizes:

SL6.0 x 100 (& 40), SL5 x 75, SL8 x 150.

PH2 x 100 (& 40), PH0 x 75, PH1 x 75, PH2 x 100, PH3 x 150.

The specially designed diamond tips reduce the risk of breaking.



Art. 1056-WW

7-Piece Ultra Low Profile Torx Handles T10-T40

Screwdrivers and Key Sets > Screwdrivers

Low profile head allows use within restricted areas.

Diamond coated tips which provide more grip for loosening and fastening screws and allows longer lasting use.

Sizes: Torx - T10, T15, T20, T25, T27, T30, T40.

Steel handles.



Art. 4057-WW

Screwdriver Set; T-Handle with Interchangeable Heads

Screwdrivers and Key Sets > Screwdrivers

Interchangeable handle.

8 x 175mm(l) double-end bits:

Ballpoint: 3, 4, 5, 6mm.

Phillips: ph. 2.

Pozi drive: pz. 2.

Ph. 3 x pz. 3.

(Slotted: 4.5 x 6.5).

8 x 1/4" dr. Nut driver 200mm(l): 5,6,7,8,10,11,12,13mm.

1/4" dr. Bit holder 175mm(l).

1/4" dr hex. Adapter.

Material: s2(blades), cr-v(socket).



Art. 5012-WW

Screwdriver Set; T-Handle with Interchangeable Heads, Torx

Screwdrivers and Key Sets > Screwdrivers

One double ended blade with TS-/T profile in each of the following sizes: 10, 15, 20, 25, 27, 30, 40.

All blades with tamper-proof heads.

One handle fits all sizes.

Length: 300 mm.



Art. 5019-WW

Screwdriver Set; JIS Type

Screwdrivers and Key Sets > Screwdrivers

4-Piece JIS Screwdriver Set for Japanese industrial standard screws as used on Japanese products and vehicles.

For Use On: Toyota, Honda, Mitsubis, Shimano parts etc.

Sizes Include: 2 x 38mm long, 1 x 75mm long, 2 x 100mm long, 3 x 150mm long.

Manufactured from Chrome Vanadium.

The Japanese cross-point screwdrivers are recommended to help prevent Cam out and damage to the screws when working on Japanese branded products.

Similar to Phillips® but with a smaller centre point profile.



Art. 7065-WW

Screwdriver Set; Precision Type with Picks

Screwdrivers and Key Sets > Screwdrivers

Contains the following screwdrivers and hooks:

2 Slotted screw drivers: 2.5 mm - 3.5 mm.

2 cross slot screwdrivers: PH0 - PH00.

4 T-Star screwdriver: TX6-TX7 TX8-TX10.

4 Hooks: 45° - 90° - 135° - 180°.

2-component handle.

Length approx: 170mm.



Art. 78908-WW

Screwdriver Set; Torx

Screwdrivers and Key Sets > Screwdrivers

End-to-end hex. blade with outer hexagon for extra torque when using.

Contains:

Screwdriver, T6 x 80 mm.

Screwdriver, T7 x 80 mm.

Screwdriver, T8 x 80 mm.

Screwdriver, T9 x 80 mm.

Screwdriver, T10 x 80 mm.

Screwdriver, T15 x 80 mm.



Art. 800021-UTC

Screwdriver Set; Go-Through, 12pcs

Screwdrivers and Key Sets > Screwdrivers

Can be used with a spanner or socket.

Ergonomic handle.

Sizes: (length without handle and hex.).

Plain slot screwdriver:

8 x 200 mm - 4 x 200 mm - 7 x 150 mm.

6 x 100 mm - 5 x 75 mm - 3.2 x 75 mm.

6 x 38 mm.

Cross screwdriver:

PH3 x 150 mm - PH3 x 150 mm.

PH1 x 75 mm - PH0 x 75 mm.

PH2 x 38 mm.



Art. 800022-UTC

Screwdriver Set; Flexi-Tips with Bits

Screwdrivers and Key Sets > Screwdrivers

Screwdrivers: 6.0mm x 167mm Long Flexible Shafted Screwdriver.
7.0mm x 167mm Long Flexible Shafted Screwdriver.
8.0mm x 167mm Long Flexible Shafted Screwdriver.
Torx bits T10, T15, T20, T25 & T30.
Flat: 5.5 & 6.5.
Phillips: PH1 & PH2.



Art. 800067-UTC

Screwdriver Set; Tamper Proof Torx

Screwdrivers and Key Sets > Screwdrivers

Screwdriver, T6 x 80 mm.
Screwdriver, T7 x 80 mm.
Screwdriver, T8 x 80 mm.
Screwdriver, T9 x 80 mm.
Screwdriver, T10 x 80 mm.
Screwdriver, T15 x 80 mm.
Screwdriver, T20 x 80 mm.
Screwdriver, T25 x 80 mm.
Screwdriver, T27 x 100 mm.
Screwdriver, T30 x 100 mm.
Screwdriver, T40 x 150 mm



Art. 8025-WW

Screwdriver Set; Go-Through, Green, 12pcs

Screwdrivers and Key Sets > Screwdrivers

Can be used with a spanner or socket.
Ergonomic handle.
Sizes: (length without handle and hex.).
2446-WW: Slot SL, 9.5mm x 200mm.
2447-WW: Slot SL, 8mm x 150mm.
2448-WW: Slot SL, 6mm x 100mm.
2449-WW: Slot SL, 6mm x 38mm.
2450-WW: Slot SL, 5mm x75mm.
2451-WW: Slot SL, 3.2mm x 75mm.
2452-WW: Cross Slot, PH4 200mm.
2453-WW: Cross Slot, PH3 150mm.
2454-WW: Cross Slot, PH2 100mm.
2455-WW: Cross Slot, PH2 38mm.
2456-WW: Cross Slot, PH1 75mm.
2457-WW: Cross Slot: PH0 75mm.



Art. 825-1-WW

Screwdriver Set; Go-Through, Orange, 12pcs

Screwdrivers and Key Sets > Screwdrivers

Can be used with a spanner or socket.
Ergonomic handle.
Sizes: (length without handle and hex.).
2446-WW: Slot SL, 9.5mm x 200mm.
2447-WW: Slot SL, 8mm x 150mm.
2448-WW: Slot SL, 6mm x 100mm.
2449-WW: Slot SL, 6mm x 38mm.
2450-WW: Slot SL, 5mm x75mm.
2451-WW: Slot SL, 3.2mm x 75mm.
2452-WW: Cross Slot, PH4 200mm.
2453-WW: Cross Slot, PH3 150mm.
2454-WW: Cross Slot, PH2 100mm.
2455-WW: Cross Slot, PH2 38mm.
2456-WW: Cross Slot, PH1 75mm.
2457-WW: Cross Slot: PH0 75mm.



Art. 825-2-WW

Screwdriver Set; Go-Through, Black, 12pcs

Screwdrivers and Key Sets > Screwdrivers

Can be used with a spanner or socket.
Ergonomic handle.

Sizes: (length without handle and hex.).

2446-WW: Slot SL, 9.5mm x 200mm.

2447-WW: Slot SL, 8mm x 150mm.

2448-WW: Slot SL, 6mm x 100mm.

2449-WW: Slot SL, 6mm x 38mm.

2450-WW: Slot SL, 5mm x 75mm.

2451-WW: Slot SL, 3.2mm x 75mm.

2452-WW: Cross Slot, PH4 200mm.

2453-WW: Cross Slot, PH3 150mm.

2454-WW: Cross Slot, PH2 100mm.

2455-WW: Cross Slot, PH2 38mm.

2456-WW: Cross Slot, PH1 75mm.

2457-WW: Cross Slot: PH0 75mm.

Art. 825-WW



Screwdriver, Hex Key & Bit Set, 44-Piece

Screwdrivers and Key Sets > Screwdrivers

Comprehensive screwdriver, hex key and bit set, supplied with a variety of differing sized tools capable of fulfilling a wide range of tasks around the home or workshop.

6 plain slot screwdrivers size: 2 x 3 x 75mm, 5 x 75mm, 5 x 100mm 6 x 100mm and 8 x 150mm.

4 cross slot screwdrivers: No.0 x 75mm, No.1 x 75mm, No.1 x 100mm and No.2 x 100mm.

4 PZ TYPE screwdrivers: No.0 x 75mm, No.1 x 100mm, No.2 x 100mm and No.3 x 150mm.

3 Draper STAR screwdrivers: T8 x 75mm, T10 x 100mm and T15 x 100mm.

1/4" magnetic bit holding driver.

3 x 1/4" plain slot insert bits size: 5, 6 and 7mm.

3 x 1/4" PZ TYPE insert bits: No.1, No.2 and No.3.

4 x 1/4" STAR bits: T7, T8, T9, and T10.

8 metric hex keys: 1.5, 2, 2.5, 3, 4, 5, 5.5 and 6mm.

8pc imperial hex keys: 1/16, 5/64, 3/32, 1/8, 5/32, 3/16, 7/32, 1/4".

Art. 800090-UTC



Bit Key Set; Lok-Typ™, 1.5-10 mm

Screwdrivers and Key Sets > Key Sets

No need for tap and die kits, this simple tool.

Works fast and efficiently every time.

Up to 85% rounded nuts.

Sizes: 1.5 - 2 - 2.5 - 3 - 4 - 5 - 6 - 8 - 10mm.

Art. 1235-WW



9-Piece Extra Long L-Type Key Set, T-Star T10-T50

Screwdrivers and Key Sets > Key Sets

Sizes: T10, T15, T20, T25, T27, T30, T40, T45, T50.

Art. 1824-WW



9-Piece Extra Long L-Type Key Set, Hex H1.5-H10

Sizes: H1.5, H2, H2.5, H3, H4, H5, H6, H8, H10.

Screwdrivers and Key Sets > Key Sets



Art. 1820-WW

9-Piece L-Type Key Set, Ball Hex H1.5-H10

Sizes: H1.5, H2, H2.5, H3, H4, H5, H6, H8, H10.

Screwdrivers and Key Sets > Key Sets



Art. 1821-WW

9-Piece L-Type Key Set, Hex H1.5-H10

Sizes: H1.5, H2, H2.5, H3, H4, H5, H6, H8, H10.

Screwdrivers and Key Sets > Key Sets



Art. 1822-WW

9-Piece L-Type Key Set, T-Star T10-T50

Sizes: T10, T15, T20, T25, T27, T30, T40, T45, T50.

Screwdrivers and Key Sets > Key Sets



Art. 1823-WW

9-Piece Extra Long L-Type Key Set, Ball Hex H1.5-H10

Screwdrivers and Key Sets > Key Sets

Sizes: H1.5, H2, H2.5, H3, H4, H5, H6, H8, H10.



Art. 1825-WW

9-Piece Hex Key Wrench Set 1-10mm S2

Screwdrivers and Key Sets > Key Sets

Metric hex profile.

Sizes: 1.5, 2, 2.5, 3, 4, 5, 8, 10 mm.

Made from impact resistant S2 steel.



Art. 4022-WW

13-Piece Torx Key Wrench Set T6-T50 S2

Screwdrivers and Key Sets > Key Sets

Torx profile.

Sizes: T6, 7, 8, 9, 10, 15, 20, 25, 27, 30, 40, 45, 50.

Made from impact resistant S2 steel.



Art. 4023-WW

9-Piece Hex Key Wrench Set

Screwdrivers and Key Sets > Key Sets

Imperial hex.

Sizes: 0.05, 1/16, 5/64, 3/32, 1/8, 5/32, 3/16, 7/64, 9/64, 1/4, 5/16, 3/8".

Made from impact resistant S2 steel.



Art. 4024-WW

16-Piece T-Handle T-Star & Hexagon

Screwdrivers and Key Sets > Key Sets

8 T-Handle-Keys Internal Hexagon: 2x75 mm, 2.5x75 mm, 3x100 mm, 4x100 mm, 5x150 mm, 6x150 mm, 8x200 mm, 10x200 mm (ball end finish on long ends).

8 T-Handle-Keys T-Star: T10x75 mm, T15x75 mm, T20x100 mm, T25x100 mm, T30x150 mm, T40x150 mm.



Art. 800069-UTC

SOCKETRY



9-piece 1/4 & 3/8" Dr Socket Bit"

Bit Socket Assortments > Bit Sets

Sizes:
 1/4": T10, T15, T20, T25, T27, T30.
 3/8": T40, T45, T50.



Art. 1055-WW

28-Piece Bit Socket Torxs Plus

Bit Socket Assortments > Torx Bit Assortments

55 mm: 20, 25, 27, 30, 40, 45, 50, 55, 60 IP.
 100 mm: 20, 25, 27, 30, 40, 45, 50, 55, 60 IP.
 140 mm: 40, 45, 50, 55, 60 IP.
 200 mm: 40, 45, 50, 55, 60 IP.
 1/2" Drive.



Art. 11166-WW

Socket Set, Torx Bits®, S2 Steel, T6-T70

Bit Socket Assortments > Torx Bit Assortments

Made from impact resistant S2 steel.
 T6, T8, T10, T15, T20, T25, T27, T30, T40, T45, T55, T60, T70.



SINGLE SOCKETS

Available separately, in single sockets section.

Art. 1165-1-WW

Socket Set, Torx® Plus Bits, S2 Steel, 8IP-60IP

Bit Socket Assortments > Torx Bit Assortments

Made from impact resistant S2 steel.
 T8H, T10H, T15H, T20H, T25H, T27H, T30.



SINGLE SOCKETS

Available separately, in single sockets section.

Art. 1165-2-WW

Socket Set, Torx®; 3/8", E4-E24, S2 Steel

Bit Socket Assortments > Torx Bit Assortments

Made from impact resistant S2 steel.
E4, E5, E, E7, E8, E10, E12, E14, E16, E18, E20, E22, E24.



SINGLE SOCKETS

Available separately, in single sockets section.

Art. 1165-4-WW

Socket and Bit Master Set; Torx®, S2 Steel

Bit Socket Assortments > Torx Bit Assortments

Torx:
T6, T8, T10, T15, T20, T25, T27, T30, T40, T45, T55, T60, T70.
Torx Plus:
T8H, T10H, T15H, T20H, T25H, T27H, T30H, T40H, T45H, T50H, T55H, T60H.
Tamper Proof Torx:
8IP, 10IP, 15IP, 20IP, 25IP, 27IP, 30IP, 40IP, 45IP, 50IP, 55IP, 60IP.
E-Torx:
E4, E5, E6, E7, E8, E10, E12, E14, E16, E18, E20, E22, E24.
Suitable for use with air tools.
Made from impact resistant S2 steel.



Art. 1165-WW

Bit Socket Set; Torx®, Stubby Type

Bit Socket Assortments > Torx Bit Assortments

Sizes:
1/4": T8, 10, 15, 20, 25, 27.
3/8": T3.



Art. 1213-WW

Bit Socket Set; Torx®, Ball Ended, 130 mm, 1/4"

Bit Socket Assortments > Torx Bit Assortments

Sizes: T10, 15, 20, 25, 27, 30, 40.
Ideal for use in confined areas.



Art. 1214-WW

Bit Socket Set; Torx Set® T6-T70 110mm Length S2 Zinc Steel

Bit Socket Assortments > Torx Bit Assortments

1/4" DR: T6, T8, T10, T15, T20, T25, T27, T30.
 3/8" DR: T40, T45, T47, T50, T55.
 1/2" DR: T60, T70.

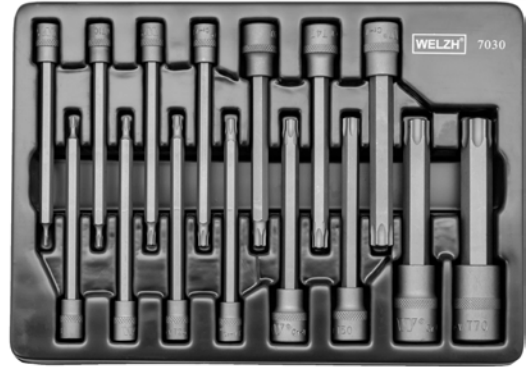

SINGLE SOCKETS

Available separately, in single sockets section.

Art. 7030-WW

Hex Key Set; 48 mm, H3-H10

Screwdrivers and Key Sets > Key Sets

7 piece set, 3/8"dr 48mm(L).
 Size: H3, H4, H5, H6, H7, H8, H10.
 Socket material: (zinc phosphate).
 Bit material: S2 (zinc phosphate).



SINGLE SOCKETS

Available separately, in single sockets section.

Art. 7038-WW

Bit Socket Master Set; 17pcs

Bit Socket Assortments > Mixed Bit Assortments

Suitable for use with impact wrenches.
 Made from S2 steel.
 H2 Bit Socket 1/4dr.
 H2.5 Bit Socket 1/4dr.
 H3 Bit Socket 1/4dr.
 H4 Bit Socket 1/4dr.
 H5 Bit Socket 1/4dr.
 H5.5 Bit Socket 1/4dr.
 H6 Bit Socket 1/4dr.
 H7 Bit Socket 3/8dr.
 H8 Bit Socket 3/8dr.
 H9 Bit Socket 3/8dr.
 H10 Bit Socket 3/8dr.
 H12 Bit Socket 3/8dr.

H14 Bit Socket 1/2dr.
 H15 Bit Socket 1/2dr.
 H17 Bit Socket 1/2dr.
 H19 Bit Socket 1/2dr.
 H22 Bit Socket 1/2dr.



SINGLE SOCKETS

Available separately, in single sockets section.

Art. 4041-WW

Socket and Bit Set; Torx; 1/2", 19pcs

Bit Socket Assortments > Torx Bit Assortments

T20, T25, T27, T30, T40, T45, T50, T55, T60, T70 E10, E11, E12, E14, E16, E18, E20, E22, E24.
 1/2" square drive.



Art. 4165-WW

Bit Socket Set; Impact, Torx, T30-80

Bit Socket Assortments > Torx Bit Assortments

Sizes: T30, T40, T45, T50, T55, T60, T70, T80.
 For use with impact wrenches.
 Length: 75 mm.
 Groove & hole for retaining ball.



SINGLE SOCKETS

Available separately, in single sockets section.

Art. 4068-WW

Bit Socket Torx Set; Low Profile, Impact, T10-50

Bit Socket Assortments > Torx Bit Assortments

Included:
 3/8" and 1/4".
 Sizes: T10, 15, 20, 25, 27, 30, 40, 45, 47, 50.



SINGLE SOCKETS

Available separately, in single sockets section.

Art. 4168-WW

Bit Socket Set; 3/8dr Torx Set 48mm T20-T45

Bit Socket Assortments > Torx Assortments

Socket Material: (Zinc Phosphate).
 Bit Material: S2 (Zinc Phosphate) 48mm(L).
 Size: T20, T25, T27, T30, T40, T45.
 6 piece set, 3/8"dr.



SINGLE SOCKETS

Available separately, in single sockets section.

Art. 7037-WW

Socket Set; Impact, Torx, E10-24, 9pcs

Bit Socket Assortments > Torx Assortments

E-Torx profile.
 Can be used with air tools.
 Sizes: E10, 11, 12, 14, 16, 18, 20, 22, 24.



Art. 9101-WW

Bit Socket Torx Assortment; 1/2" 32-Piece

Bit Socket Assortments > Torx Bit Assortments

Lengths: 55, 100, 140, 200 mm.
Drive T-Star (for Torx) T20 - T70.

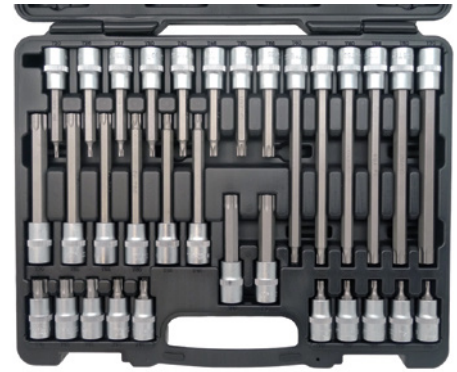

SINGLE SOCKETS

Available separately, in single sockets section.

Art. 5182-WW

12-piece Tamper Torx Set T8H-T60H S2 Zinc Steel

Bit Socket Assortments > Mixed Bit Assortments

Made from impact resistant S2 steel.
8IP, 10IP, 15IP, 20IP, 25IP, 27IP, 30IP, 40IP, 45IP, 50IP, 55IP, 60I.



SINGLE SOCKETS

Available separately, in single sockets section.

Art. 1165-3-WW

Bit Socket Set; Extra Long Torx, Hexagon, Ball-Ended Hexagon 110mm

Bit Socket Assortments > Mixed Bit Assortments

Size: HB3, HB4, HB5, HB6, HB7, HB8, HB10.
Size: T20, T25, T27, T30, T40, T45.
Size: H3, H4, H5, H6, H7, H8, H10.
Socket: 50BV30 zinc phosphate.
Bit: S2 zinc phosphate.
Length: 100mm.
3/8" Drive.



SINGLE SOCKETS

Available separately, in single sockets section.

Art. 7023-WW

Bit Socket and Adapter Set

Bit Socket Assortments > Mixed Bit Assortments

Useful when working in tight areas.
Also Included: 1/4" (hex) x 1/4", 1/4" (hex) x 3/8", 1/4" (hex) x 1/2".
1/4" to 3/8".
1/2" to 3/8".
1/2" to 3/4".
3/4" to 1/2".
1/4" 1/4" hex.
1/4" 8mm hex.
3/8" 8mm hex.
3/8" 10mm hex.
1/2" 10mm hex.
1/4" hex bit holder.
1/4" Quick release bit holder.



Art. 2886-WW

Bit Socket Set; 3/8dr Extra Long Torx Set 110mm T20-T45

Bit Socket Assortments > Torx Bit Assortments

3/8"dr Extra Long Torx Set 110mm T20-T45.



SINGLE SOCKETS

Available separately, in single sockets section.

Art. 7023-1-WW

Bit Socket Master Set; Impact, 6pt, Spline, Torx

Bit Socket Assortments > Mixed Bit Assortments

Ideal for use with air tools especially when working in confined areas.

Spline: M4, 5, 6, 8, 10, 12, 14, 16, 18.

Torx: T10, 15, 20, 25, 27, 30, 40, 45, 47, 50.

Hex: H6, 7, 8, 10, 12, 14, 17, 18, 19.



Art. 2890-WW

Bit Master Set; 81 pcs

Bit Socket Assortments > Mixed Bit Assortments

Torx Bit Socket:

1/4: T6, T8, T10, T15, T20, T25, T27, T30.

3/8: T40, T47, T50, T55.

1/2: T60, T70.

Torx Plus Bit Socket:

1/4: TP8, TP10, TP15, TP20, TP25, TP27, TP30.

3/8: TP40, TP45, TP50, TP55.

1/2: TP60.

Torx External Socket:

1/4: E4, E5, E6, E7, E8.

3/8: E10, E12, E14, E16.

1/2: E18, E20, E22, E24.

Torx Resistant Socket:

1/4: TT8, TT10, TT15, TT20, TT25, TT27, TT30.

3/8: TT40, TT45, TT50, TT55.

1/2: TT60.

Hex Bit Socket:

1/4: H2, H2.5, H3, H4, H5, H5.5, H6.

3/8: H7, H8, H9, H10, H12.

1/2: H14, H15, H17, H19, H22.

Spline Bit Socket:

1/4: M4, M5, M6.

3/8: M7, M8, M9, M10.

1/2: M12, M13, M14, M16, M18.

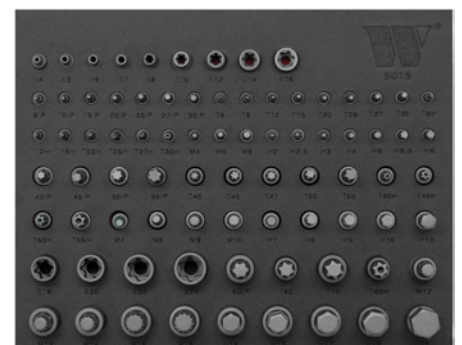

Art. 5015-WW

Bit Socket Assortment Set; 44 pcs

Bit Socket Assortments > Mixed Bit Assortments

Screwdriver bits covering most sizes.

Hardened tempered steel for long lasting use.

Most popular 1 inch insert & 2 inch power screwdriver bits.

Finder driver for stable long screw driving.



Art. 8035-WW

Bit Socket Set; 6pt, Stubby Type

Bit Socket Assortments > Hex Bit Assortments

Sizes:
 1/4": 4, 5, 6, 7, 8 mm.
 3/8": 10, 12, 14mm.
 1/2": 17, 19 mm.
 6-pt.



Art. 1212-WW

Bit Socket Hex Assortment; 1/2"

Bit Socket Assortments > Hex Bit Assortments

Sizes:
 55mm: H5, H6, H7, H8, H10, H12, H14, H17, H19.
 100mm: H5, H6, H7, H8, H10, H12, H14.
 140mm: H5, H6, H7, H8, H10, H12.
 200mm: H5, H6, H7, H8, H10, H12.
 1/2" square drive.
 Hex profile.
 Torx and Spline sets also available.



Art. 5181-WW

Bit Socket Set; Master Hex Bit Set 110 mm Length

Bit Socket Assortments > Hex Bit Assortments

1/4" DR: H2, H2.5, H3, H4, H5, H5.5, H6.
 3/8" DR: H7, H8, H9, H10, H12.
 1/2" DR: H14, H15, H17, H19, H22.

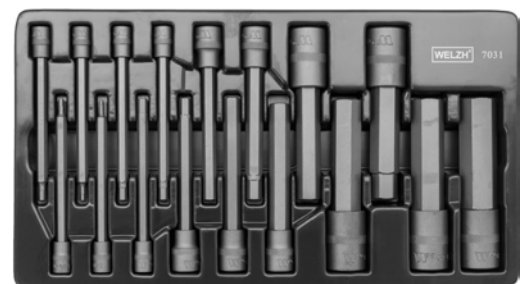

SINGLE SOCKETS

Available separately, in single sockets section.

Art. 7031-WW

Bit Socket Set; Impact, 6pt, H5-18

Bit Socket Assortments > Hex Bit Assortments

Sizes: H5, 6, 8, 10, 12, 14, 17, 19.
 For use with impact wrenches.
 Length: 75 mm.
 Groove & hole for retaining ball.



SINGLE SOCKETS

Available separately, in single sockets section.

Art. 4071-WW

Bit Socket Hex Set; Low Profile, Impact, 6-19mm

3/8" and 1/4".
 Sizes: H6, 7, 8, 10, 12, 14, 17, 18, 19.

Art. 4169-WW

Bit Socket Assortments > Hex Bit Assortments



Hex Assortment Set 3/8dr

H3, H4, H5, H6, H7, H8, H10.
 Length: 110mm.
 3/8" drive.

Art. 5189-WW

Bit Socket Assortments > Hex Bit Assortments



Bit Socket Set; 3/8dr Extra Long Allan Key Set 110mm H3-H10

Includes: H3, H4, H5, H6, H7, H8, H10.
 Allan key head.
 110mm Long.
 3/8" square drive.

Art. 7023-2-WW

Bit Socket Assortments > Hex Bit Assortments



Bit Socket Set; 3/8dr Extra Long Ball Allan Key Set 110mm HB3-HB10

Includes: H3, H4, H5, H6, H7, H8, H10.
 Ball Allan key head.
 110mm Long.
 3/8" square drive.

Art. 7023-3-WW

Bit Socket Assortments > Hex Bit Assortments



Bit Socket Set; 3/8dr Ball Allan Key Set 48mm HB3-HB10

Sizes: HB3, HB4, HB5, HB6, HB7, HB8, HB10.
 Socket material: (zinc phosphate).
 Bit material: s2 (zinc phosphate).
 7 peice set: 3/8"dr 48mm(L).

Art. 7039-WW

Bit Socket Assortments > Hex Bit Assortments



88-piece 1/2" Bit Socket Sets: Spline

Bit Socket Assortments > Spline Assortments

Spline, Hex and Torx bit socket assortment sets, each supplied in its own protective carry case. 1/2" Drive on all sockets.

26-Piece Spline Bit Assortment:

55 mm: M5, M6, M8, M9, M10, M12, M14, M16.
100 mm: M5, M6, M8, M9, M10, M12, M14.
140 mm: M5, M6, M8, M9, M10, M12, M14.
200 mm: M8, M10, M12, M14.

30-Piece Hex Bit Assortment Set:

55 mm: 5, 6, 7, 8, 10, 12, 14, 17, 19 mm.
100 mm: 5, 6, 7, 8, 10, 11, 12, 13 mm.
140 mm: 5, 6, 7, 8, 10, 12, 14 mm.
200 mm: 5, 6, 7, 8, 10, 12 mm.

32-Piece Torx Bit Assortment Set:

55 mm: T20, 25, 27, 30, 40, 45, 50, 55, 60, 70.
100 mm: T20, 25, 27, 30, 40, 45, 50, 55, 60, 70.
140 mm: T40, 45, 50, 55, 60, 70.
200 mm: T40, 45, 50, 55, 60, 70.



Art. 800072-UTC

Bit Socket Spline Set; Low Profile, Impact, M4-18

Bit Socket Assortments > Spline Bit Assortments

Sizes: M4, 5, 6, 8, 10, 12, 14, 16, 18.
1/2, 3/8" and 1/4".



SINGLE SOCKETS

Available separately, in single sockets section.

Art. 4167-WW



Bit Socket Spline Assortment; 1/2" M5-M16

Bit Socket Assortments > Spline Bit Assortments

Satin chrome plated, knurled.
Length: 55, 100, 140, 200 mm.
M5-M16.
S2-Steel.



SINGLE SOCKETS

Available separately, in single sockets section.

Art. 5180-WW



Bit Socket Set; Impact, Spline, M5-18

Bit Socket Assortments > Spline Bit Assortments

Sizes: M5, M6, M8, M10, M12, M14, M16, M18.
Groove & hole for retaining ball.
For use with impact wrenches.
Length: 75 mm.



SINGLE SOCKETS

Available separately, in single sockets section.

Art. 4070-WW



Bit Socket Set; 3/8dr Extra Long Spline Set 110mm M4-M10

Bit Socket Assortments > Spline Bit Assortments

Sizes: M4, M5, M6, M7, M8, M9, M10.
Length: 110 mm.
3/8" Drive.



SINGLE SOCKETS

Available separately, in single sockets section.

Art. 7023-4-WW

Bit Socket Master Set; Spline, 12pcs

Bit Socket Assortments > Bit Sockets

Made from s2 steel suitable for use with impact wrenches.
1/2" M12, 13, 14, 16, 18.
3/8" M7, 8, 9, 10.
1/4" M4, 5, 6.



SINGLE SOCKETS

Available separately, in single sockets section.

Art. 4054-WW

Bit Set; 1/2" and 3/8"; Hex, Torx and Spline; S2 Steel Range

Bit Socket Assortments > Bit Sockets

- H10 - Hex Bit; 10 x 30 mm (6882-30-H10-WW).
- H12 - Hex Bit; 10 x 30 mm (6882-30-H12-WW).
- H4 - Hex Bit; 10 x 30 mm (6882-30-H4-WW).
- H5 - Hex Bit; 10 x 30 mm (6882-30-H5-WW).
- H6 - Hex Bit; 10 x 30 mm (6882-30-H6-WW).
- H7 - Hex Bit; 10 x 30 mm (6882-30-H7-WW).
- H8 - Hex Bit; 10 x 30 mm (6882-30-H8-WW).
- H10 - Hex Bit; 10 x 75 mm (6882-75-H10-WW).
- H12 - Hex Bit; 10 x 75 mm (6882-75-H12-WW).
- H4 - Hex Bit; 10 x 75 mm (6882-75-H4-WW).
- H5 - Hex Bit; 10 x 75 mm (6882-75-H5-WW).
- H6 - Hex Bit; 10 x 75 mm (6882-75-H6-WW).
- H7 - Hex Bit; 10 x 75 mm (6882-75-H7-WW).
- H8 - Hex Bit; 10 x 75 mm (6882-75-H8-WW).
- M10 - Spline Bit; 10 x 30 mm (6882-30-M10-WW).
- M12 - Spline Bit; 10 x 30 mm (6882-30-M12-WW).
- M5 - Spline Bit; 10 x 30 mm (6882-30-M5-WW).
- M6 - Spline Bit; 10 x 30 mm (6882-30-M6-WW).
- M8 - Spline Bit; 10 x 30 mm (6882-30-M8-WW).
- M10 - Spline Bit; 10 x 75 mm (6882-75-M10-WW).
- M12 - Spline Bit; 10 x 75 mm (6882-75-M12-WW).
- M5 - Spline Bit; 10 x 75 mm (6882-75-M5-WW).
- M6 - Spline Bit; 10 x 75 mm (6882-75-M6-WW).
- M8 - Spline Bit; 10 x 75 mm (6882-75-M8-WW).
- T20 - Torx Bit; 10 x 30 mm (6882-30-T20-WW).
- T25 - Torx Bit; 10 x 30 mm (6882-30-T25-WW).
- T30 - Torx Bit; 10 x 30 mm (6882-30-T30-WW).
- T40 - Torx Bit; 10 x 30 mm (6882-30-T40-WW).
- T45 - Torx Bit; 10 x 30 mm (6882-30-T45-WW).
- T50 - Torx Bit; 10 x 30 mm (6882-30-T50-WW).
- T55 - Torx Bit; 10 x 30 mm (6882-30-T55-WW).
- T20 - Torx Bit; 10 x 75 mm (6882-75-T20-WW).
- T25 - Torx Bit; 10 x 75 mm (6882-75-T25-WW).
- T30 - Torx Bit; 10 x 75 mm (6882-75-T30-WW).
- T40 - Torx Bit; 10 x 75 mm (6882-75-T40-WW).
- T45 - Torx Bit; 10 x 75 mm (6882-75-T45-WW).
- T50 - Torx Bit; 10 x 75 mm (6882-75-T50-WW).
- T55 - Torx Bit; 10 x 75 mm (6882-75-T55-WW).



SINGLE SOCKETS

Available separately, in single sockets section.



Art. 6882-WW

Bit Set; Impact, 1" and 3/4" 16-Piece Set

Bit Socket Assortments > Bit Sockets

Ideal for use on HGV's and farm vehicles.
 Torx: T60, 70, 80, 90, 100.
 Hex: 17, 19, 22, 24 mm.
 ETorx: E18, 20, 22, 24.
 Hex key: 4 mm.
 3/4" bit holder.
 1" bit holder.



Art. 4140-WW

Bit Master Set; Spline, Hex, Torx, Tamperproof Torx, 54pcs

Bit Socket Assortments > Bit Sockets

Adapter 1/2"dr x 10mm.
 Adapter 3/8"dr x 10mm.
 30mm Hex bit: 4, 5, 6, 7, 8, 10, 12mm.
 75mm Hex bit: 4, 5, 6, 7, 8, 10, 12mm.
 30mm Spline bit: M5, 6, 8, 10, 12.
 75mm Spline bit: M5, 6, 8, 10, 12.
 30mm Torx bit: T20, 25, 30, 40, 45, 50, 55.
 75mm Torx bit: T20, 25, 30, 40, 45, 50, 55.
 30mm Security torx: T20, 25, 30, 40, 45, 50, 55.
 75mm Security torx: T20, 25, 30, 40, 45, 50, 55.



Art. 6880-WW

Bit Set; 40pcs

Bit Socket Assortments > Bit Sockets

Includes following tools:
 14 internal hexagon bits, short and long type 4 - 5 - 6 - 7 - 8 - 10 - 12 mm.
 14 T-Star bits, short and long type T20 - T25 - T30 - T40 - T45 - T50 - T55.
 10 Spline bits, short and long type M5 - M6 - M8 - M10 - M12.
 10 mm bit adapter with 3/8" drive.
 10 mm bit adapter with 1/2" drive.



Art. 6881-WW

Bit Set; Coloured, 32pcs

Bit Socket Assortments > Bit Sockets

Intelligent colour guide, one colour for each profile.
 Includes the following tools:
 30 bits, length: 25 mm.
 Plain slot 3-4-5-6 mm.
 Cross slot PH1 - PH2 - PH2 - PH3.
 Cross slot PZ1 - PZ2 - PZ2 - PZ3.
 Internal hexagon 3 - 4 - 5 - 6 mm.
 T-Star (for Torx) T10 - T15 - T20 - T25 - T27 - T30 - T40.
 T-Star tamper proof (for Torx): T10 - T15 - T20 - T25 - T27 - T30 - T40.
 1 quick chuck bit holder.
 1 bit adaptor.



Art. 7067-WW

Bit Socket Set; 1/4"

Slotted: SL1, SL5.5, SL7.
PHPS: PH1, PH2, PH3.
PZI: PZ1, PZ2, PZ3.
Hex: H3, H4, H5, H6, H7, H8.
T-Star: T10, T15, T20, T25, T27, T30, T40.
Spline: M4, M5, M6, M8, M10.

Bit Socket Assortments > Mixed Bit Sockets



Art. 4218-WW

Bit Socket Set; Master Spline Bit Set 110 mm Length

1/4" DR: M4, M5, M6.
3/8" DR: M7, M8, M9, M10.
1/2" DR: M12, M13, M14, M16, M18.

Bit Socket Assortments > Ribe Spline Assortments

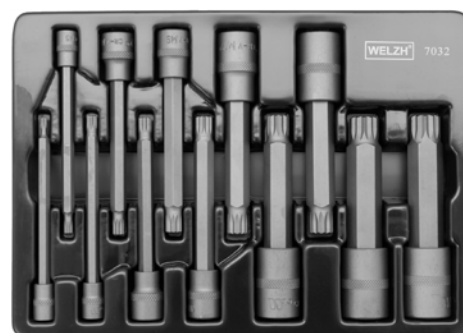

SINGLE SOCKETS
Available separately, in single sockets section.

Art. 7032-WW

Bit Socket Set; Master Ribe Set 110 mm Length

1/4" DR: RM4, RM5, RM6.
3/8" DR: RM7, RM8, RM9, RM10.
1/2" DR: RM12, RM13, RM14.

Bit Socket Assortments > Ribe Bit Assortments



Art. 7033-WW

DRIVE ADAPTORS & EXTENSION BARS



Socket Adaptor 1/4" (Internal) X 3/8" (External)

Chrome Accessories > Adapters and Reducers



Art. 1084-1-WW

Socket Adaptor 3/8" (Internal) X 1/4" (External)

Chrome Accessories > Adapters and Reducers



Art. 1084-2-WW

Socket Adaptor 1/2" (Internal) X 3/8" (External)

Chrome Accessories > Adapters and Reducers



Art. 1084-3-WW

Socket Adaptor 3/8" (Internal) X 1/2" (External)

Chrome Accessories > Adapters and Reducers



Art. 1084-4-WW

Socket Adaptor 3/4" (Internal) X 1/2" (External)

Chrome Accessories > Adapters and Reducers



Art. 1084-5-WW

Socket Adaptor 1/2" (Internal) X 3/4" (External)

Chrome Accessories > Adapters and Reducers



Art. 1084-6-WW

6-Piece Adaptor Set

Chrome Accessories > Adapters and Reducers

Contains:
1/4" int. X 3/8" ext.
3/8" int. X 1/4" ext.
3/8" int. X 1/2" ext.
1/2" int. X 3/8" ext.
1/2" int. X 3/4" ext.
3/4" int. X 1/2" ext.



Art. 1084-WW

2-Piece Uni-Adaptors

Chrome Accessories > Adapters and Reducers

Set of two two-way square drive adapters.
Adapter 1: 1/4" to 3/8".
Adapter 2: 3/8" to 1/2".



Art. 6116-WW

Lok-Reach™ Extension Bar 1/4 - 3/8 dr

Chrome Accessories > Extension Bars

Ratchet mechanism within the bar means that only the hand ratchet needs to move or if you use an air ratchet there is no movement.

To be used with 3/8" ratchet.

Can be used with 3/8" or 1/4" sockets.

We recommend our range of stubby sockets and bit sockets.

High quality design made to last.



Art. 4058-WW

5-Piece 1/4" Drive Wobble Extension Bar Set

Chrome Accessories > Extension Bars

1/4" drive.

Length: 50, 75, 100, 150 and 225mm.



Art. 6110-WW

5-Piece 3/8" Drive Wobbel Extension Bar Set

Chrome Accessories > Extension Bars

3/8" drive.

Length: 8, 75, 150, 250 and 450mm.



Art. 6111-WW

5-Piece 1/2" Drive Wobble Extension Bar Set

Chrome Accessories > Extension Bars

1/2" drive.

Length: 50, 75, 125, 250 and 450mm.



Art. 6112-WW

9-Piece 1/2 , 3/8 , 1/4" Drive Wobble Extension Bar Set

Chrome Accessories > Extension Bars

1/4" drive:
Length: 50, 75, 100, 150 and 225mm.
3/8" drive:
Length: 8, 75, 150, 250 and 450mm.
1/2" drive:
Length: 50, 75, 125, 250 and 450mm.



Art. 800080-UTC

9-Piece 1/2 , 3/8 , 1/4" Drive Wobble Extension Bar Set

Chrome Accessories > Extension Bars

1/4" drive:
Length: 50, 75, 100, 150 and 225mm.
3/8" drive:
Length: 8, 75, 150, 250 and 450mm.
1/2" drive:
Length: 50, 75, 125, 250 and 450mm.



Art. 6113-WW

Wobble Extension Bar Set 9-piece 1/4, 3/8 & 1/2 Drive

Chrome Accessories > Extension Bars

1/4" drive:
Length: 50, 75, 100, 150 and 225mm.
3/8" drive:
Length: 8, 75, 150, 250 and 450mm.
1/2" drive:
Length: 50, 75, 125, 250 and 450mm.



Art. 6117-WW

Wobble Extension Bar Set 9-piece 1/4 , 3/8 & 1/2 Drive Magnetic Version

Chrome Accessories > Extension Bars

1/4" drive:
Length: 50, 75, 100, 150 and 225mm.
3/8" drive:
Length: 8, 75, 150, 250 and 450mm.
1/2" drive:
Length: 50, 75, 125, 250 and 450mm.
Magnetic tips.



Art. 6118-WW

3-Piece Extra Long Extension Bar Set 3/8dr 375-450-600 mm

Chrome Accessories > Extension Bars

Sizes Included: 375mm, 450mm, 600mm.
3/8" Drive.



Art. 6114-WW

3-Piece Extra Long Extension Bar Set 1/2dr 450-600-750 mm

Chrome Accessories > Extension Bars

Sizes Included: 450mm, 600mm, 750mm.
1/2" Drive.

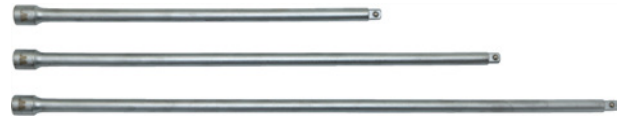

Art. 6115-WW

Extension Bar 1/4" dr 50mm

Chrome Accessories > Extension Bars

Heavy duty professional extension bar.
Length: 50 mm.
1/4" drive.



Art. 6119-WW

Extension Bar 1/4" dr 100mm

Chrome Accessories > Extension Bars

Heavy duty professional extension bar.
Length: 100 mm.
1/4" drive.



Art. 6120-WW

Extension Bar 1/4" dr 250mm

Chrome Accessories > Extension Bars

Heavy duty professional extension bar.
Length: 250 mm.
1/4" drive.



Art. 6121-WW

Extension Bar 3/8" dr 75mm

Chrome Accessories > Extension Bars

Heavy duty professional extension bar.
Length: 75 mm.
3/8" drive.



Art. 6123-WW

Extension Bar 3/8" dr 150mm

Chrome Accessories > Extension Bars

Heavy duty professional extension bar.
Length: 150 mm.
3/8" drive.



Art. 6124-WW

Extension Bar 3/8" dr 250 mm

Chrome Accessories > Extension Bars

Heavy duty professional extension bar.
Length: 250 mm.
3/8" drive.



Art. 6125-WW

Extension Bar 1/2" dr 50mm

Chrome Accessories > Extension Bars

Heavy duty professional extension bar.
Length: 50 mm.
1/2" drive.



Art. 6126-WW

Extension Bar 1/2" dr 125mm

Chrome Accessories > Extension Bars

Heavy duty professional extension bar.
Length: 125 mm.
1/2" drive.



Art. 6127-WW

Extension Bar 1/2" dr 250mm

Chrome Accessories > Extension Bars

Heavy duty professional extension bar.
Length: 250 mm.
1/2" drive.



Art. 6128-WW

FIND US ON FACEBOOK

fb.com/WelzhWerkzeugLtd



IMPACT ADAPTORS

SETS & SINGLE UNITS



Impact Reducer 3/4\"/>

Socket adaptor: 3/4\"/>

Impact Accessories > Impact Adapters and Reducers



Art. 7064-WW

3-Piece Mini Impact Adaptor Set 1/4X36, 3/8X1/2, 1/2X3/4,

Can be used with air tools.
Extra stubby design.
Sizes: 1/4\"/>

Impact Accessories > Impact Adapters and Reducers



Art. 4043-WW

Adapter Set; Impact, 1/4\"/>

For use with impact wrenches and air tools.
Included:
1/4\"/>

Impact Accessories > Impact Adapters and Reducers



Art. 4116-1-WW

Ball Joint; Impact

Impact Accessories > Impact Adapters and Reducers

1/4" Drive
Can be used with air tools.



Art. 4116-10-WW

Ball Joint; Impact

Impact Accessories > Impact Adapters and Reducers

3/8" Drive
Can be used with air tools.



Art. 4116-11-WW

Ball Joint; Impact

Impact Accessories > Impact Adapters and Reducers

1/2" Drive
Can be used with air tools.



Art. 4116-12-WW

Impact Wrench Adaptor, 1/4" int. - 3/8" ext

Impact Accessories > Impact Adapters and Reducers

Can be used with air tools.
Found in set 4116-WW.



Art. 4116-2-WW

Impact Wrench Adaptor, 3/8" int. - 1/4" ext

Impact Accessories > Impact Adapters and Reducers

Can be used with air tools.
Found in set 4116-WW.



Art. 4116-3-WW

Impact Wrench Adaptor, 3/8" int. - 1/2" ext

Impact Accessories > Impact Adapters and Reducers

Can be used with air tools.
Found in set 4116-WW.



Art. 4116-4-WW

Impact Wrench Adaptor, 1/2" int. - 3/8" ext

Impact Accessories > Impact Adapters and Reducers

Can be used with air tools.
Found in set 4116-WW.



Art. 4116-5-WW

Impact-Adaptor, 1/2" int. - 3/4" ext

Impact Accessories > Impact Adapters and Reducers

Can be used with air tools.
Found in set 4116-WW.



Art. 4116-6-WW

Impact-Adaptor, 3/4" int. - 1/2" ext

Impact Accessories > Impact Adapters and Reducers

Can be used with air tools.
Found in set 4116-WW.



Art. 4116-7-WW

Impact-Adaptor, 3/4" int. - 1" ext

Impact Accessories > Impact Adapters and Reducers

Can be used with air tools.



Art. 4116-8-WW

Impact-Adaptor, 1" int. - 3/4" ext

Impact Accessories > Impact Adapters and Reducers

Can be used with air tools.



Art. 4116-9-WW

Adapter Set; Impact, 1/4"-3/4"

Impact Accessories > Impact Adapters and Reducers

Sizes:
1/4" internal to 3/8" external.
3/8" internal to 1/4" external.
3/8" internal to 1/2" external.
1/2" internal to 3/8" external.
1/2" internal to 3/4" external.
3/4" internal to 1/2" external.



Art. 4116-WW

IMPACT SOCKETS

SETS & SINGLE UNITS

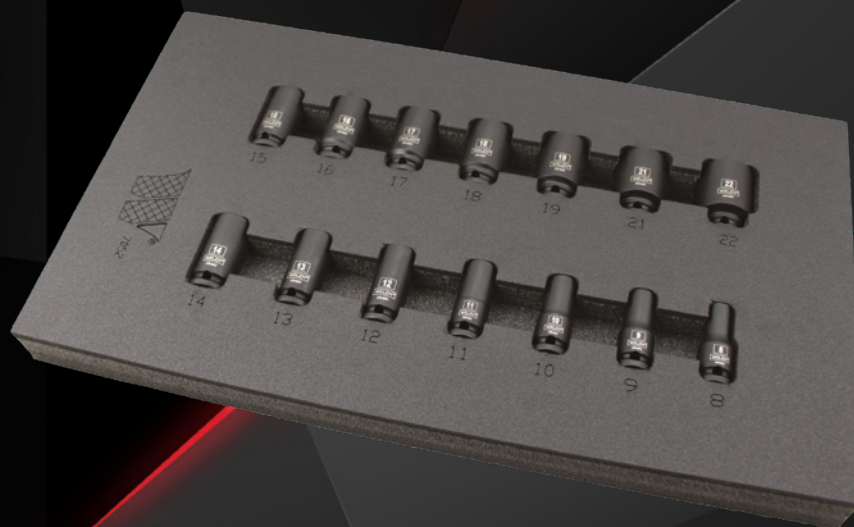

Socket Set; 3/8", Deep, Impact (Lok-Typ™) 8-19 mm

Specially designed to remove rounded or worn nuts (up to 85%).
Benefit compared to twist sockets is the ability for the socket to be used as a standard hex socket.

Sizes: 8, 9, 10, 11, 12, 13, 14, 15, 16, 17, 18, 19 mm.

Impact Socket Assortments > 3/8" Impact Assortments



SINGLE SOCKETS

Available separately, in single sockets section.

Art. 1094-WW

Socket Set; Impact, Extra Stubby, 3/8"

Perfect for tight and confined spaces.
Also suitable for everyday use.
Use with the 3118-WW Ultra mini impact wrench for a perfect pairing.

Impact Socket Assortments > 3/8" Impact Assortments



Art. 2889-WW

Socket Set; 1/2", Deep, Impact (Lok-Typ™) 10-32 mm

Impact Socket Assortments > 1/2" Impact Assortments

Specially designed to remove rounded or worn nuts (up to 85%). Benefit compared to twist sockets is the ability for the socket to be used as a standard hex socket.

Sizes: 10, 11, 12, 13, 14, 15, 16, 17, 18, 19, 21, 22, 24, 27, 30 mm.



SINGLE SOCKETS

Available separately, in single sockets section.

Art. 1095-WW

Socket Set; Impact, Extra Stubby, 1/2"

Impact Socket Assortments > 1/2" Impact Assortments

Sizes: 10, 12, 13, 14, 15, 16, 17, 18, 19, 21, 22, 24, 27, 30, 31 mm.

Ultra stubby impact sockets, suitable for use with air tools.

10mm deep.

1/2" drive.



Art. 2888-WW

Socket Set; Impact, 6pt, Deep, 10-32 mm, 1/2"

Impact Socket Assortments > 1/2" Impact Assortments

Hex profile.

Length: 78 mm.

Sizes: 10, 12, 13, 14, 15, 17, 18, 19, 21, 22, 24, 27, 30, 32 mm.

1/2" drive.

Can be used with air tools.



SINGLE SOCKETS

Available separately, in single sockets section.

Art. 4119-WW

Socket Set; Deep, Impact, Dynamic Wall Drive, 10-32 mm

Impact Socket Assortments > 1/2" Impact Assortments

Sizes: 10, 11, 12, 13, 14, 15, 16, 17, 18, 19, 21, 22, 24, 27, 30, 32 mm.

Suitable for use with air tools.

6 point.

Deep.



SINGLE SOCKETS

Available separately, in single sockets section.

Art. 4162-WW

Socket Set: Deep Impact, 1/2", 12pt, Dynamic Wall Drive, 10-32 mm

Impact Socket Assortments > 1/2" Impact Assortments

Sizes: 10, 11, 12, 13, 14, 15, 16, 17, 18, 19, 21, 22, 24, 27, 30, 32 mm.
Suitable for use with air tools.
12-Point.
Deep.



SINGLE SOCKETS

Available separately, in single sockets section.

Art. 60070-WW

Socket Set; Extra Long (120 mm), Impact, 1/2"

Impact Socket Assortments > 1/2" Impact Assortments

Sizes: 10, 12, 13, 14, 15, 17, 18, 19, 21, 22, 24, 27, 30, 32 mm.
6 Point / Hex Sockets.
120mm length.



SINGLE SOCKETS

Available separately, in single sockets section.

Art. 7001-WW

Socket Set: Shallow, Impact, 1/2", Lok-Typ, 10-32 mm

Impact Socket Assortments > 1/2" Impact Assortments

LOK-TYP sockets have been designed by improving the point contact between the socket & the fastener by achieving liner contact.

Sizes: 10, 11, 12, 13, 14, 15, 16, 17, 18, 19, 21, 22, 24, 27, 30, 32mm.
Remove up to 85% rounded bolts with ease.
Shallow socket set.



SINGLE SOCKETS

Available separately, in single sockets section.

Art. 7024-WW

Semi Deep Thin Walled Impact Sockets, 1/2", 6pt

Impact Socket Assortments > 1/2" Impact Assortments

Designed to withstand the torque of an impact socket with the wall dimension of a standard socket.

Sizes: 10, 11, 12, 13, 14, 15, 16, 17, 18, 19, 21, 22, 23, 24, 27, 30, 32 mm.



SINGLE SOCKETS

Available separately, in single sockets section.

Art. 7051-WW

Semi Deep Thin Walled Impact Sockets, 3/8", 6pt 10-21mm

Impact Socket Assortments > 1/2" Impact Assortments

Designed to withstand the torque of an impact socket with the wall dimension of a standard socket.
Can be used with hand tools or air tools.
Sizes: 9, 10, 11, 12, 13, 14, 15, 16, 17, 18, 19, 21, 22 mm.



SINGLE SOCKETS

Available separately, in single sockets section.

Art. 7052-WW

Socket Set; Impact, Deep and Shallow, 1/4"

Impact Socket Assortments > 1/4" Impact Assortments

Shallow: 4, 4.5, 5, 5.5, 6, 7, 8, 9, 10, 11, 12, 13, 14, 15 mm.
Deep: 4, 4.5, 5, 5.5, 6, 7, 8, 9, 10, 11, 12, 13, 14, 15 mm.
Can be used with air tools.
1/4" Drive.



Art. 4147-WW

Socket Set; Deep, Impact, 3/4", 6pt, 22-50 mm

Impact Socket Assortments > 3/4" Impact Assortments

Sizes: 22, 24, 27, 30, 32, 36, 38, 41, 46, 50mm.
With groove and hole for retaining ball.
Can be used with air tools.
1" drive.
6 point.



SINGLE SOCKETS

Available separately, in single sockets section.

Art. 5022-WW

Socket Set; Deep, Impact, 6pt, 22-50 mm, 10pcs

Impact Socket Assortments > 1" Impact Assortments

Sizes: 22, 24, 27, 30, 32, 36, 38, 41, 46, 50mm.
With groove and hole for retaining ball.
Can be used with air tools.
1" drive.
6 point.



SINGLE SOCKETS

Available separately, in single sockets section.

Art. 8036-WW

BREAKER BARS

AND REPLACEMENT HEADS



Twisting Hand Ratchet

Hand Tools > Breaker Bar Accessories

Fine 60 tooth ratchet.
Coated non slip handle.
Quick release head.
Push through style.
Perfect for confined areas and everyday workshop use.
Twist handles.



1/4" Art. 1203-WW

3/8" Art. 1204-WW

1/2" Art. 1205-WW

Extra Long Twisting Hand Ratchet

Hand Tools > Breaker Bar Accessories

Fine 60 tooth ratchet.
Coated non slip handle.
Quick release head.
Push through style.
Perfect for confined areas and everyday workshop use.
Twist handles.
Extra long handle.



1/4" Art. 7004-WW

3/8" Art. 7005-WW

1/2" Art. 7006-WW

Breaker Bar; Non Slip Handle and Oil Resistant, 24", 1/2"

Breaker Bars > 1/2" Breaker Bars

Length: 24".
Hardened and tempered steel.
Non slip oil resistant rubber grip.
1/2" drive.

Replacement head available under Art. 267-REPAIR-WW



Art. 11106-WW

Breaker Bar; 24", 1/2"

Breaker Bars > 1/2" Breaker Bars

Length: 24".
Hardened and tempered.
Load capacity: 500NM.

Replacement head available under Art. 267-REPAIR-WW



Art. 10267-WW

Breaker Bar; 39", 1"

Breaker Bars > 1" Breaker Bars

Length: 39".
Impact resistant head.
Improved leverage.



Art. 4206-WW

Breaker Bar; 39", 3/4"

Breaker Bars > 3/4" Breaker Bars

Length: 39".
The longer length allows for greater leverage.
3/4" drive.

Replacement head available under Art. 4207-1-WW



Art. 4207-WW

Ratchet Set; Composite, 1/2", 3/8", 1/4"

Ratchets > Ratchet Sets

Classic offset ratchet style with special composite coating to protect expensive parts.
 Fine 72 tooth ratchet.
 Quick switch left and right.
 Quick release button.
 Ratchet repair kits available.

Also available to order separately as:

1/2" - 719-WW
 3/8" - 718-WW
 1/4" - 717-WW



Art. 720-WW

Ratchet Set; Telescopic

Ratchets > 1/2" Single Ratchets

Fine 72 tooth ratchet.
 Reversible with quick switch.
 Telescopic: 1/4" - 180-230mm, 3/8" - 240-340mm, 1/2" - 340-480mm.
 Spring ball socket retention.
 Ratchet repair kits available.

Also available to order separately as:

1/2" - 11113-WW
 3/8" - 11112-WW
 1/4" - 11111-WW



Art. 11118-WW

Ratchet Set; Telescopic with Flexi-Head, 1/2", 3/8", 1/4"

Ratchets > Ratchet Sets

Square Drive: 1/4, 3/8 & 1/2.
 Extending Telescopic Handle.
 Versatile Flexi-head.
 Ratchet repair kits available.

Also available to order separately as:

1/2" - 11102-WW
 3/8" - 11103-WW
 1/4" - 11104-WW

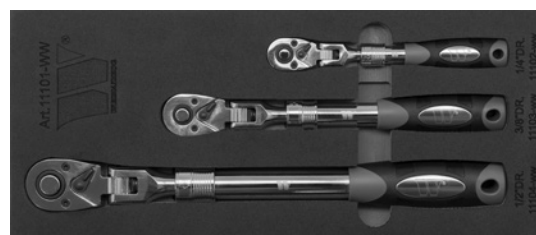

Art. 11101-WW

Ratchet Set; Telescopic with Flexi-Head and Lock, 1/2", 3/8", 1/4"

Ratchets > Ratchet Sets

Included:
 Art. 11108 - 1/4.
 Fine 72 tooth.
 Reversible.
 Telescopic: (175 - 225mm).
 Coated non slip handles.
 Lockable head.
 Art. 11109 - 3/8.
 Fine 72 tooth.
 Reversible.
 Telescopic: (240 - 340mm).
 Coated non slip handles.
 Lockable head.
 Art. 11110 - 1/2.
 Fine 72 tooth.

Reversible.
 Telescopic: (345 - 495mm).
 Coated non slip handles.
 Lockable head.
 Ratchet repair kits available.

Also available to order separately as:

1/2" - 11110-WW
 3/8" - 11109-WW
 1/4" - 11108-WW

Art. 11115-WW



Ratchet Set; Extra Long, Fixed Head, 1/2", 3/8", 1/4"

Ratchets > Ratchet Sets

Extra Long Ratchet Kit.
Exceeds ANSI specs.
Comfort soft grip.
72 tooth drive.
Supplied in EPA Foam Case.
Ratchet repair kits available.

Also available to order separately as:

1/2" - 11130-WW

3/8" - 11129-WW

1/4" - 11128-WW



Art. 11127-WW

Ratchet Set; Stubby, 1/2", 3/8", 1/4"

Ratchets > Ratchet Sets

Extra stubby for use in confined spaces.
Fine 72 tooth ratchet.
Quick Release.
Sizes:
1/2": 140 mm.
3/8": 104 mm.
1/4": 85 mm.



Art. 11116-WW

Ratchet Set; Classic, 1/2", 3/8", 1/4"

Ratchets > Ratchet Sets

Art. 1102 - 1/4.
Fine 72 tooth.
Reversible.
Art. 1103 - 3/8.
Fine 72 tooth.
Reversible.
Art. 1104 - 1/2.
Fine 72 tooth.
Reversible.
Ratchet repair kits available.

Also available to order separately as:

1/2" - 1104-WW

3/8" - 1103-WW

1/4" - 1102-WW

Art. 11117-WW



Ratchet Set; Extra Long, Flexi-Head, 1/2", 3/8", 1/4"

Ratchets > Ratchet Sets

Extra Long Flex-Head Ratchet Kit.
180 degree flex-heads (non locking).
Exceeds ANSI specs.
Comfort soft grip.
72 tooth drive.
Supplied in EPA Foam Case.
Ratchet repair kits available.

Also available to order separately as:

1/2" - 11125-WW

3/8" - 11124-WW

1/4" - 11123-WW



Art. 11126-WW

1/4dr Poco Aluminium Ratchet Red Series

Ratchets > Ratchet Repair Kits

Ultra small design for access to tight spaces.
72-tooth ratchet.
Ultra-lite.



Art. 11107-WW

3/4"dr Hand Ratchet

Ratchets > Ratchet Repair Kits

Classic ratchet style with all metal construction.
Fine 72 tooth ratchet.
Quick switch left and right.
Quick release button.



Art. 1105-WW

1/4"dr Twisting Stubby Hand Ratchet

Ratchets > Ratchet Repair Kits

Ultra stubby style.
Push through style.
Perfect for confined areas and everyday workshop use.
Twist handles.



Art. 1246-WW

3/4"Dr Telescopic Ratchet

Ratchets > Ratchets

Extra large heavy duty telescopic ratchet.
Handle diameter: 3cm.
Max. length: 67cm.
Min. length: 39cm.
Reversible.



Art. 11114-WW

108-Tooth Soft Grip Handle Ratchet 3-Piece Set

Ratchets > Ratchet and Extension Bar

Fine 72 tooth ratchet.
 Reversible with quick switch.
 Telescopic: up to 770 mm (95 mm steps).
 Spring ball socket retention.
 Ratchet Repair Kits Available.

Also available to order separately as:

- 1/2" - 11122-WW
- 3/8" - 11121-WW
- 1/4" - 11120-WW



Art. 11119-WW

Reversible Ratchet Ultra Thin 3-Piece Set

Ratchets > Ratchets

Ultra thin design allows the ratchet to fit in confined spaces.
 High quality finish.
 Reversible.

Also available to order separately as:

- 1/2" - 60081-WW
- 3/8" - 60082-WW
- 1/4" - 60083-WW



Art. 60084-WW

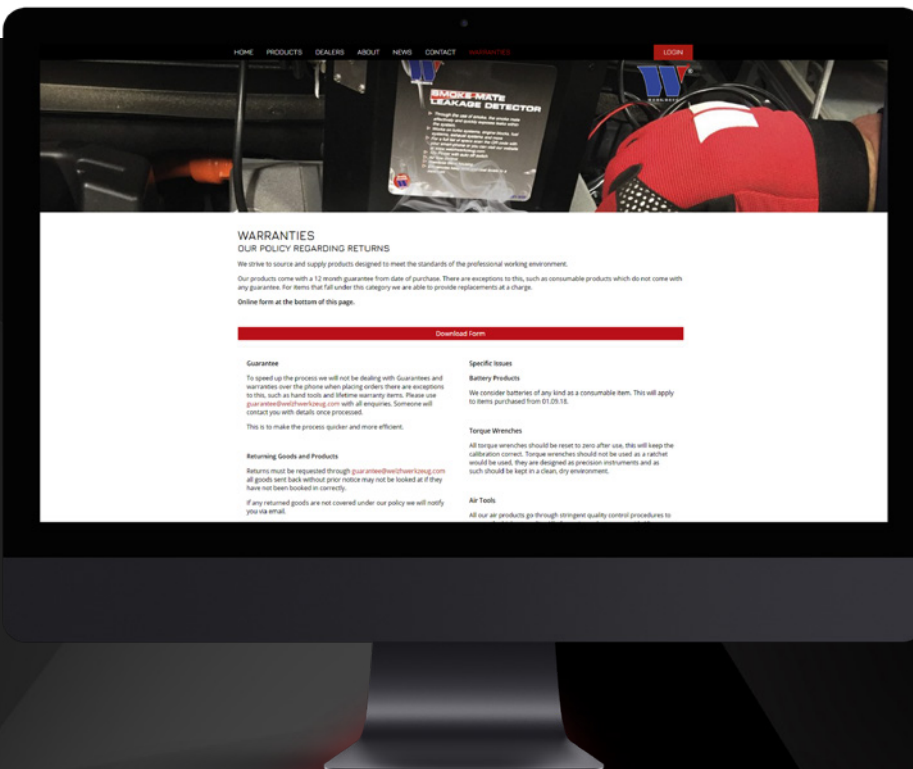

WARRANTY & REPAIRS

WELZH.COM/WARRANTIES

Socket Tool Set; 38-Piece Deep & Shallow, Chrome 6-point 3/8" (FP Series)

Socket Assortments > 1/4" Assortments

19 x Standard 6 Point Flank Drive Sockets: 6, 7, 8, 9, 10, 11, 12, 13, 14, 15, 16, 17, 18, 19, 20, 21, 22, 23, 24 mm.
12 x Deep 6 Point Flank Drive Sockets: 8, 9, 10, 11, 12, 13, 14, 15, 16, 17, 18, 19 mm.
1 x 72 Teeth Reversible Quick Release Ratchet.
2 x Deep Spark Plug Sockets.
16mm (M10), 21mm (M14).
5 x 3/8"dr Accessories.
2 x Extension Bars 75mm & 150 mm.
1 x 3 Way Adapter 1/2"F x 3/8"M.
1 x Universal Joint.



Art. 6105-WW

Socket Tool Set; 27-Piece Deep & Shallow, Chrome 6-point 1/4" (FP Series)

Socket Assortments > 1/4" Assortments

13 x Standard 6 Point Flank Drive Sockets: 4, 4.5, 5, 5.5, 6, 7, 8, 9, 10, 11, 12, 13, 14 mm.
7 x Deep 6 Point Flank Drive Sockets: 6, 7, 8, 9, 10, 11, 12, 13 mm.
1 x 72th Reversible Quick Release Ratchet.
3 x Extension Bars 50, 100 & 150 mm.
6106-3-WW: Spinner Handle; Go-Through.
6106-2-WW: Universal Joint; 1/4".
6106-1-WW: Sliding T-Bar; 1/4".
6 x 1/4"dr Accessories.



Art. 6106-WW

Socket Tool Set; 20-Piece Shallow, Chrome 6-point 1/4" (FP Series)

Socket Assortments > 1/4" Assortments

Standard 6 pt Drive Sockets: 4, 4.5, 5, 5.5, 6, 7, 8, 9, 10, 11, 12, 13, 14 mm.
72 Teeth Reversible Ratchet.
Extension Bars: 50, 100, 150mm.
Go-through Spinner Handle.
Sliding T bar.
Universal Joint.



Art. 6107-WW

Socket Tool Set; 23-Piece Shallow, Chrome 6-point 3/8" (FP Series)

Socket Assortments > 1/4" Assortments

Standard 6 pt Drive Sockets: 6, 7, 8, 9, 10, 11, 12, 13, 14, 15, 16, 17, 18, 19, 20, 21, 22 mm.
3 way Adaptor 1/2" F x 3/8"M + Sliding T Head.
Extension Bars: 75, 150, 200mm.
72 Teeth Reversible Ratchet.



Art. 6108-WW



SOCKET ASSORTMENTS

SETS & TOOL KITS

1/2 dr Lok-Typ Sockets Shallow 8-32 MM

Socket Assortments > 1/2" Assortments

Sizes: 8, 9, 10, 11, 12, 13, 14, 15, 16, 17, 18, 19, 20, 21, 22, , 23, 24, 27, 30, 32 mm.
 Speacially designed to remove rounded or worn nuts (upto 85%).
 Benefit compared to twist sockets is the ability for the socket to be used as a standard hex socket.



SINGLE SOCKETS

Available separately, in single sockets section.

Art. 1063-WW

1/2dr Multilock Sockets 8-32 mm

Socket Assortments > 1/2" Assortments

Sizes: 8, 9, 10, 11, 12, 13, 14, 15, 16, 17, 18, 19, 20, 21, 22, 24, 27, 30, 32 mm.
 Multilock sockets suitable for spline, hex and torx profiles.
 1/2" drive.



Art. 11410-WW

Socket Set; Shallow, 1/2"

Socket Assortments > 1/2" Assortments

Sizes: 10, 11, 12, 13, 14, 15, 16, 17, 18, 19, 20, 21, 22, 24, 27, 30, 32 mm.



SINGLE SOCKETS

Available separately, in single sockets section.

Art. 4141-WW

Socket Set; Deep, 1/2"

Socket Assortments > 1/2" Assortments

Sizes: 10, 11, 12, 13, 14, 15, 16, 17, 18, 19, 20, 21, 22, 23, 24 mm.



Art. 4142-WW

Socket Set; Gearlock, Shallow, 1/2"

Socket Assortments > 1/2" Assortments

Sizes: 10, 11, 12, 13, 14, 15, 16, 17, 18, 19, 20, 21, 22, 24, 27, 30, 32 mm.



Art. 4173-WW

Socket Set; Gearlock, Deep, 1/2"

Socket Assortments > 1/2" Assortments

Sizes: 10, 11, 12, 13, 14, 15, 16, 17, 18, 19, 20, 21, 22, 23, 24 mm.



Art. 4174-WW

15-Piece Lok-TYP Shallow Sockets 3/8dr 8-22mm

Socket Assortments > 3/8" Assortments

Specially designed to remove rounded or worn nuts (upto 85%).
Benefit compared to twist sockets is the ability for the socket to be used as a standard hex socket.

Sizes: 0, 11, 12, 13, 14, 15, 16, 17, 18, 19, 21, 22 mm.



SINGLE SOCKETS

Available separately, in single sockets section.

Art. 1233-WW

12-Piece Lok-Typ Sockets Deep 3/8dr 8-19mm

Socket Assortments > 3/8" Assortments

Specially designed to remove rounded or worn nuts (upto 85%).
Benefit compared to twist sockets is the ability for the socket to be used as a standard hex socket.

Sizes: 10, 11, 12, 13, 14, 15, 16, 17, 18, 19 mm.



SINGLE SOCKETS

Available separately, in single sockets section.

Art. 1234-WW

Socket Set, Shallow, 3/8"

Socket Assortments > 3/8" Assortments

Sizes: 8, 9, 10, 11, 12, 13, 14, 15, 16, 17, 18, 19, 20, 21 mm.
Plastic storage tray.



SINGLE SOCKETS

Available separately, in single sockets section.

Art. 4145-WW

Socket Set; Deep, 3/8"

Socket Assortments > 3/8" Assortments

Sizes: 8, 9, 10, 11, 12, 13, 14, 15, 16, 17, 18, 19, 20, 21 mm.
Plastic storage tray.



SINGLE SOCKETS

Available separately, in single sockets section.

Art. 4146-WW

Socket Set; Gearlock, Shallow, 3/8"

Socket Assortments > 3/8" Assortments

Sizes: 8, 9, 10, 11, 12, 13, 14, 15, 16, 17, 18, 19, 20, 21 mm.



Art. 4177-WW

Socket Set; Gearlock, Deep, 3/8"

Socket Assortments > 3/8" Assortments

Sizes: 8, 9, 10, 11, 12, 13, 14, 15, 16, 17, 18, 19, 20, 21 mm.



Art. 4178-WW

1/4" dr Lok-Typ Sockets Deep 4-13 MM

Socket Assortments > 1/4" Assortments

LOK-TYP sockets have been designed by improving the point contact between the socket and the fastener by achieving liner contact.

Remove up-to 85% rounded bolts with ease.

Sizes: 4, 5, 5.5, 6, 7, 8, 10, 11, 12 & 13mm.



SINGLE SOCKETS

Available separately, in single sockets section.

Art. 4035-WW

1/4" dr Lok-Typ Sockets Shallow 4-13 MM

Socket Assortments > 1/4" Assortments

LOK-TYP sockets have been designed by improving the point contact between the socket and the fastener by achieving liner contact.

Remove up-to 85% rounded bolts with ease.

Sizes: 4, 5, 5.5, 6, 7, 8, 10, 11, 12, 13mm.

1/4" drive.



SINGLE SOCKETS

Available separately, in single sockets section.

Art. 4036-WW

Socket Set; Shallow, 1/4"

Socket Assortments > 1/4" Assortments

Sizes: 4, 4.5, 5, 5.5, 6, 7, 8, 9, 10, 11, 12, 13, 14 mm.
Plastic storage tray.
Shallow sockets.
1/4" drive.



SINGLE SOCKETS

Available separately, in single sockets section.

Art. 4143-WW

Socket Set; Deep, 1/4"

Socket Assortments > 1/4" Assortments

Sizes: 4, 4.5, 5, 5.5, 6, 7, 8, 9, 10, 11, 12, 13, 14 mm.
Plastic storage tray.
Deep socket.



SINGLE SOCKETS

Available separately, in single sockets section.

Art. 4144-WW

Socket Set; Gearlock, Shallow, 1/4"

Socket Assortments > 1/4" Assortments

Sizes: 4, 4.5, 5, 5.5, 6, 7, 8, 9, 10, 11, 12, 13, 14 mm.
Shallow.



Art. 4175-WW

Socket Set; Gearlock, Deep, 1/4"

Socket Assortments > 1/4" Assortments

Sizes: 4, 4.5, 5, 5.5, 6, 7, 8, 9, 10, 11, 12, 13, 14 mm.
Deep.



Art. 4176-WW

Socket Tool Set; 12pt, 19-50 mm, 3/4"

Socket Tools Sets > 3/4" Socket Tool Set

Included:
Extension bars: 200, 410 mm.
Sliding t-bar: 455 mm.
500 mm ratchet.
Sockets 12-Point Profile.
Sockets: 19, 21, 22, 23, 24, 26, 27, 30, 32, 34, 36, 38, 41, 46, 48, 50 mm.



Art. 11105-WW

Socket Tool Set; 6pt, 19-50 mm, 3/4"

Socket Tools Sets > 3/4" Socket Tool Set

Included:
Extension bars: 200, 410 mm.
Sliding t-bar: 455 mm.
500 mm ratchet.
Sockets 6-Point Profile.
Sockets: 19, 21, 22, 23, 24, 26, 27, 30, 32, 34, 36, 38, 41, 46, 48, 50 mm.



Art. 11131-WW

Socket Tool Set; 12pt, 19-50 mm, 3/4"

Socket Tools Sets > 3/4" Socket Tool Set

Included:
Extension bars: 200, 410 mm.
Sliding t-bar: 455 mm.
500 mm ratchet.
Sockets: 19, 21, 22, 23, 24, 26, 27, 30, 32, 34, 36, 38, 41, 46, 48, 50 mm.



Art. 800065-UTC

Socket Tool Set; 6Pt, 36-80mm, 1"

Socket Tools Sets > 1" Assortments

Included:
24 tooth reversible ratchet 680 mm long.
2 extension bars 200 and 400 mm.
500 mm sliding t-bar with adapter for loosening nuts.
Sockets: 36, 41, 46, 50, 55, 60, 65, 70, 75, 80 mm.
Ideal for heavy duty applications.
6pt hex profile.



Art. 1222-WW

Socket Tool Set; 12Pt, 36-80mm, 1"

Socket Tools Sets > 1" Assortments

Included:
 24 tooth reversible ratchet 680 mm long.
 2 extension bars 200 and 400 mm.
 500 mm sliding t-bar with adapter for loosening nuts.
 Sockets: 36, 41, 46, 50, 55, 60, 65, 70, 75, 80 mm.
 Ideal for heavy duty applications.
 12pt bi-hex profile.



Art. 1223-WW

Socket Tool Set; 6Pt, 36-80mm, 1"

Socket Tools Sets > 1" Socket Tool Set

Sizes: 36, 38, 41, 46, 50, 54, 55, 58, 60, 63, 65, 67, 70, 71, 75, 77, 80mm.
 1 X 8" (200mm) Extension Bar.
 1 X 16" (400mm) Extension Bar.
 1 X Universal Handle With Sliding Head.
 1 X 1" Drive Ratchet.



Art. 800073-UTC

Socket Tool Set; Deep and Shallow, 1/4"

Socket Tools Sets > 1/4" Socket Tool Set

1/4 Adapter.
 Spinning handle.
 Sliding t-bar.
 Extension bars: 50 & 100 mm.
 Universal Joint.
 Flexible extension bar.
 1/4 reversible ratchet.
 Hex keys x 3.
 Torx bit sockets: T10, 15, 20, 25, 30, 40.
 Pozi bit sockets: No. 1, 2, 3.
 Slotted bit sockets: 4, 5.5, 7 mm.
 Hex bit sockets: 3, 4, 5, 6, 7, 8 mm.
 Cross bit sockets: No. 1, 2, 3.
 Super lock sockets: 4, 4.5, 5, 5.5, 6, 7, 8, 9, 10, 11, 12, 13, 14mm.
 Satin finish.

Art. 4104-WW



Socket Tool Set with Bits; 1/4"

Socket Tools Sets > 1/4" Socket Tool Set

1/4" Adapter.
 Spinning handle.
 Sliding t-bar.
 Extension bars: 50 & 100 mm.
 Universal Joint.
 Flexible extension bar.
 1/4 reversible ratchet.
 Hex keys x 3.
 Torx bit sockets: T10, 15, 20, 25, 30, 40.
 Pozi bit sockets: No. 1, 2, 3.
 Slotted bit sockets: 4, 5.5, 7 mm.
 Hex bit sockets: 3, 4, 5, 6, 7, 8 mm.
 Cross bit sockets: No. 1, 2, 3.
 Super lock sockets: 4, 4.5, 5, 5.5, 6, 7, 8, 9, 10, 11, 12, 13, 14mm.
 Satin finish.

Art. 4172-WW



Socket Tool Set; 1/2"

Socket Tools Sets > 1/2" Socket Tool Set

Sizes: 10, 11, 12, 13, 14, 15, 16, 17, 18, 19, 20, 21, 22, 23, 24, 27, 28, 30, 32 mm.
 2 wobble type extension bars (125 & 250 mm).
 1 adaptor for extension bars.
 72-tooth reversible ratchet.
 6pt sockets.



Art. 4137-WW

Socket Tool Set; Chrome, 1/4", 3/8", 1/2" (191 pcs)

Socket Tools Sets > Mixed Drive Socket Tool Set

1/2" Contents:

72 tooth ratchet.
 Extensions: 125 & 250mm.
 Bit holder for 8 mm bits.
 Female Torx: E20, E24.
 Universal Joint.
 Shallow sockets: 0, 11, 12, 13, 14, 15, 16, 17, 18, 19mm.
 Deep sockets: 6, 17, 18, 19, 22 mm.

1/4" Contents:

72 tooth ratchet.
 Extensions: 50 & 100 mm.
 1/4" bit holder.
 Female Torx: E4, 5, 6, 7, 8.
 Sliding T-bar.
 6.3mm handle.
 Universal joint.
 Shallow sockets: 4, 4.5, 5, 5.5, 6, 7, 8, 9, 10, 11, 12, 13, 14mm.
 Deep sockets: 4, 5, 6, 7, 8, 9, 10mm.
 Phillips bits: No. 0, 1, 2.
 Pozi bits: No. 0, 1, 2.

Slot bits: 4, 5.5, 6, 7 mm.
 Torx bits: T8, 9, 10, 14, 20, 25, 27, 30.
 Tamper torx: T9, 10, 15, 20, 25, 27, 30.
 Hex bits: 3, 4, 5, 6mm.

Contents: 3/8":

72 tooth ratchet.
 Extension: 150 mm.
 Bit holder for 8 mm bits.
 Female Torx: E10, 11, 12, 14, 16, 18.
 Spark plug socket 18 mm.
 10 mm adapter.
 Universal joint.
 Shallow sockets: 10, 11, 13, 14, 15, 16, 17, 18, 19mm.
 Deep sockets: 0, 11, 12, 13, 14, 15mm.
 8 mm slotted bit: 8, 10, 12 mm.
 8 mm cross bit: Ph3, Ph4, Pz3 Pz4.
 8 mm hex bit: 7, 8, 9, 10, 12, 14.
 8 mm torx bit: T40, 45, 50, 55, 60, 70.
 8 mm tamper torx bit: 40, 45, 50, 55, 60, 70mm.



Art. 4188-WW

Socket Tool Set; Gearlock Sockets, 1/4", 3/8", 1/2"

Socket Tools Sets > Mixed Drive Socket Tools Sets

1/4" Contents:

72 tooth ratchet.
 6.3 mm handle.
 Sliding t-bar.
 Extensions: 50 and 100 mm.
 1/4" bit holder.
 Female Torx: E4, 5, 6, 7, 8.
 Universal joints.
 Shallow sockets: 4, 4.5, 5, 5.5, 6, 7, 8, 9, 10, 11, 12, 13, 14 mm.
 Deep sockets: 4, 5, 6, 7, 8, 9, 10 mm.
 Phillips bits: No. 0, 1, 2.
 Pozi bits: No. 0, 1, 2.
 Slot bits: 4, 5.5, 6, 7, mm.
 Torx bits: T8, 9, 10, 14, 20, 25, 27, 30.
 Tamper torx: T9, 10, 15, 20, 25, 27, 30.
 Hex bits: 3, 4, 5, 6 mm.

3/8" Contents:

72 tooth ratchet.
 Extension: 150 mm.
 Bit holder for 8 mm bits.

Female Torx: E10, 11, 12, 14, 16, 18.
 Universal joint.
 Spark plug socket 18 mm.
 10 mm adapter.
 Shallow sockets: 10, 11, 13, 14, 15, 16, 17, 18, 19 mm.
 Deep sockets: 10, 11, 12, 13, 14, 15 mm.

1/2" Contents:

72 tooth ratchet.
 Extensions: 125 & 250 mm.
 Bit holder for 8 mm bits.
 Female torx: E20, E24.
 Shallow sockets: 10, 11, 12, 13, 14, 15, 16, 17, 18, 19, 20, 21, 22, 24, 27, 30, 32 mm.
 Deep sockets: 16, 17, 18, 19, 22 mm.



Art. 4150-WW

Socket Tool Set; Satin, 1/4", 3/8", 1/2" (191 pcs)

Socket Tools Sets > Mixed Drive Socket Tool Set

1/4" Contents:

72 tooth ratchet.
6.3 mm handle.
Sliding t-bar Extensions: 50 and 100 mm.
1/4" bit holder.
Female torx: E4, 5, 6, 7, 8.
Universal joints.
Shallow sockets: 4, 4.5, 5, 5.5, 6, 7, 8, 9, 10, 11, 12, 13, 14 mm.
Deep sockets: 4, 5, 6, 7, 8, 9, 10 mm.
Phillips bits: No. 0, 1, 2.
Pozi bits: No. 0, 1, 2.
Slot bits: 4, 5.5, 6, 7, mm.
Torx bits: T8, 9, 10, 14, 20, 25, 27, 30.
Tampor torx: T9, 10, 15, 20, 25, 27, 30.
Hex bits: 3, 4, 5, 6 mm.

3/8" Contents:

72 tooth ratchet.
Extension: 150 mm.
Bit holder for 8 mm bits.

Female torx: E10, 11, 12, 14, 16, 18.
Universal joint.
Spark plug socket 18 mm 10 mm adapter.
Shallow sockets: 10, 11, 13, 14, 15, 16, 17, 18, 19.
Deep sockets: 10, 11, 12, 13, 14, 15.
1/2" Contents:
72 tooth ratchet.
Extensions: 125 & 250 mm.
Bit holder for 8 mm bits.
Female torx: E20, E24.
Shallow sockets: 10, 11, 12, 13, 14, 15, 16, 17, 18, 19, 20, 21, 22, 24, 27, 30, 32 mm.
Deep sockets: 16, 17, 18, 19, 22 mm.
8 mm slotted bit: 8, 10, 12 mm.
8 mm cross bit: Ph3, Ph4, Pz3 Pz4.
8 mm hex bit: 7, 8, 9, 10, 12, 14.
8 mm torx bit: T40, 45, 50, 55, 60, 70.
8 mm tampor orx bit: T40, 45, 50, 55, 60, 70.

Art. 4189-WW



Socket Set; Go-Through, 1/4", 3/8", 1/2"

Socket Tools Sets > Mixed Drive Socket Tool Set

Go-Through system is suitable for extra long fixings and rods, as it removes the depth limit of standard sockets.

Set includes:

22mm Hex Drive:
72-Tooth Go-Through ratchet, 22mm inner Hex.
Go-Through extension bar, 75mm.
7x Gear Lock Sockets, approx. 40mm long.
Sizes: 19, 20, 21, 22, 23, 24, 25mm.
Adapter: 22mm outer Hex to 1/2" outer square, for ratchet.
Adapter: 22mm inner Hex to 1/2" inner square, for extension bar.
19mm Hex Drive:
72-Tooth Go-Through ratchet, 19mm inner Hex.
Go-Through extension bar, 75mm.
11x Gear Lock Sockets, 30mm long.
Sizes: 8, 10, 11, 12, 13, 14, 15, 16, 17, 18, 19mm.

Adapter: 19mm outer Hex to 3/8" outer square, for ratchet.
Adapter: 19mm inner Hex to 3/8" inner square, for extension bar.
13mm Hex Drive:
72-Tooth Go-Through ratchet, 13mm inner Hex.
Go-Through extension bar, 75mm.
11x Gear Lock Sockets, 25mm long.
Sizes: 4.5, 5, 5.5, 6, 7, 8, 9, 10, 11, 12, 13mm.
Adapter: 13mm outer Hex to 1/4" outer square.
Adapter: 13mm inner Hex to 1/4" inner square, for extension bar.
Adapter: 13mm outer Hex to 1/4" inner Hex, allows the ratchet be used as a standard 1/4" ratchet.
1/4" Drive Bits:
Slot bits: 4 & 5mm.
T-Star bits: T10, T15, T20.
Cross slot bits: PH1 & PH2.
Inner Hex bits: 4, 5 & 6 mm.

Art. 60059-WW



Socket Tool Set; Satin, 1/4", 3/8", 1/2" (216 pcs)

Socket Tools Sets > Mixed Drive Socket Tool Set

1/2" drive:

Reversible ratchet.
Extension bar 125 +250 mm.
Sliding bar adaptor and universal joint.
2 spark plug sockets 16 + 21 mm.
Adapter 3/8" to 1/2".
14x sockets 13-14-15-16-17-18-19-20-21-22-24-27-30-32 mm.
5x deep sockets 16-17-19-21-22 mm.
3x E-Type sockets E20 - E22 - E24.
2x bit sockets, T-Star T70, int. Hex. socket H1.

3/8" drive:

Reversible ratchet.
Extension bar 125 mm.
Universal joint and sliding bar adaptor.
Spark plug socket 18 mm.
Sliding bar adaptor.
10x sockets 10-11-12-13-14-15-16-17-18-19 mm.

6x deep sockets 10-11-12-13-14-15 mm.
7x E-Type sockets E10-12-14-16-18.
30x bits.
1/4" drive:
Reversible ratchet.
50 +100 mm extension bar.
Universal joint and sliding bar adaptor.
13x sockets: 4-4, 5-5-5, 5-6-7-8-9-10-11-12-13-14 mm.
7x deep sockets 4-5-6-7-8-9-10 mm.
5x E-Type sockets E4 - 5 - 6 - 7 - 8.
30x bit sockets with spinner handle.
44x bits.
Bit adapter.
12x combination spanner 8-19 mm.
7x int. Hex wrench 1.2 - 5 mm.
1x bit screwdriver.

Art. 7060-WW



Socket Tool Set; 1/4" & 1/2" 95-Piece

Socket Tools Sets > Mixed Drive Socket Tool Set

1/4" Drive:

13 Sockets: 4, 4.5, 5, 5.5, 6, 7, 8, 9, 10, 11, 12, 13, 14 mm.
8 Deep Sockets: 6, 7, 8, 9, 10, 11, 12, 13 mm.
72-Tooth Quick release curved shank ratchet handle.
2 Extension bars: 2" & 4".
Universal Joint.
Double ended spinner handle.
110mm Sliding T-bar.

1/2" Drive:

17 Sockets: 10-11-12-13-14-15-16-17-18-19-20-21-22-24-27-30-32 mm.
5 Deep sockets: 14-15-17-19-22 mm.
72-Tooth Quick release curved shank ratchet handle.
2 Spark plug sockets: 16 & 21 mm.
2 Extension bars: 125 mm & 250 mm.
Universal Joint.
Adaptor for sliding T-bar.
1/2"DR(F) X 8MM HEX(F) Coupler.

Accessories:

3 Hex key wrenches: 1.5, 2, 2.5 mm.

18 1/4"Dr. bit sockets:

3 Slotted: 4, 5.5, 6.5 mm.
2 Phillips: No. 1, 2.
2 Pozidriv: No. 1, 2.
4 Hex: 3, 4, 5, 6 mm.
7 Torx: T8, T10, T15, T20, T25, T27

17 30L 8mm hex bits:

3 Slotted: 8, 10, 12 mm.
2 Phillips: No. 3, 4.
2 Pozidriv: No. 3, 4.
5 Hex: 7, 8, 10, 12, 14 mm.
5 Torx: T40, T45, T50, T55, T60.



Art. 7063-WW

Socket Tool Set; 1/2" (Imperial Sizes)

Socket Tools Sets > Mixed Drive Socket Tool Set

An extensive 92-piece socket tool set including a range of standard, deep, spark plug and bit sockets as well as a number of ratchets, wrenches, extension bars and other accessories.

1/4" Drive: 5/32", 3/16", 7/32", 1/4", 9/32", 5/16", 11/32", 3/8", 7/16", 1/2"
1/4" Deep: 1/4", 5/16", 3/8", 7/16", 1/2".
3/8" Drive: 1/2", 9/16", 5/8", 11/16", 3/4", 25/32", 13/16", 7/8", 15/16", 1".
3/8" Deep: 9/16", 5/8", 11/16", 3/4".
Combination Wrenches: 1/16", 5/64", 3/32", 1/8", 5/32", 3/16", 1/4", 5/16", 3/8".
Hex key wrenches: 1/16", 5/64", 3/32", 1/8", 5/32", 3/16", 1/4", 5/16", 3/8".
29 bits: 7 Slotted, 7 Hex, 7 Torx, 4 Phillips, 4 Pozidriv.
3/8" & 1/4" fine 72 tooth ratchets.
1/4" Spinner handle & sliding t-bar.
1/4" universal joint & coupler.
1/4" + 3/8" short & deep sockets.

Art. 7061-WW

Socket Tool Set; 3/8"

Socket Tools Sets > 3/8" Socket Tool Set

Included:

Shallow sockets: 6, 7, 8, 9, 10, 11, 12, 13, 14, 15, 16, 17, 18, 19, 20, 21, 22, 24 mm.
Deep sockets: 8, 9, 10, 11, 12, 13, 14, 15, 16, 17, 18, 19 mm.
1 x fine 32 tooth ratchet.
Spark plug sockets: 16 & 21 mm.
Wobble extension bars: 75 & 250 mm.
Universal joint with spring.
8mm hex adapter.
Slotted bits: 5.5, 6, 6.
Phillips bits: 1, 2, 3.
Pozi bits: 1, 2, 3.
Hex: bits: 3, 4, 5, 6, 7, 8, 10 mm.
Torx bits: T15, 20, 25, 27, 30, 40, 45, 50, 55.

Art. 4204-WW



Socket Tool Set; Deep and Shallow, Chrome, 1/4"

Socket Tools Sets > 1/4" Socket Tool Set

1/4" Adapter.
Spinning handle.
Sliding t-bar.
Extension bars: 50 & 100 mm.
Universal Joint.
Flexible extension bar.
1/4" reversible ratchet.
Hex keys x 3.
Torx bit sockets: T10, 15, 20, 25, 30, 40.
Pozi bit sockets: No. 1, 2, 3.
Slotted bit sockets: 4, 5.5, 7 mm.
Hex bit sockets: 3, 4, 5, 6, 7, 8 mm.
Cross bit sockets: No. 1, 2, 3.
Super lock sockets: 4, 4.5, 5, 5.5, 6, 7, 8, 9, 10, 11, 12, 13, 14mm.
Satin finish.

Art. 4187-WW



Torque Multiplier Set 1"Dr

Socket Tools Sets > 1/4" Socket Tool Set

For loosening stuck wheel nut sockets on trucks and vans
Maximum torque 3200 Nm - gear ratio 1:56
Includes 7 sockets - socket sizes: 24-27-30-32-33-36-38 mm

Art. 800070-UTC

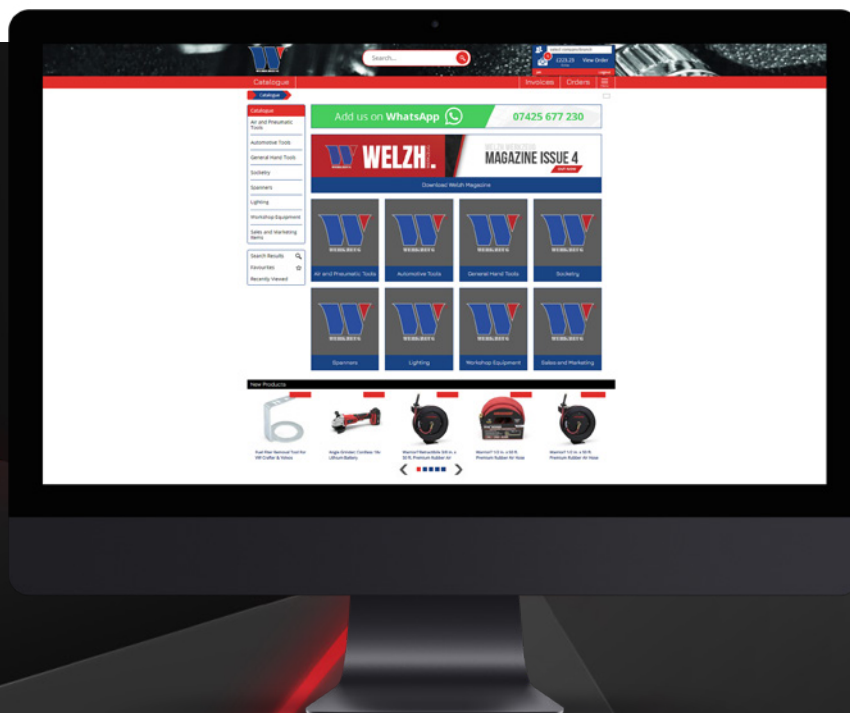

ONLINE B2B

WWW.WELCH.COM

LOCKING WHEEL NUT SOCKETS

KEYS, REMOVERS & PROTECTIVE SOCKETS



Protective Impact Sockets 17, 19, 21 mm

Designed for use when working on expensive parts such as alloy wheels.
Can be used with air tools.
Sizes: 17, 19, 21 mm.

Specialist Sockets > Wheel Nut Sockets



SINGLE SOCKETS

Available separately, in single sockets section.



**CONSUMABLE
PRODUCT**

Not covered by warranty.

Art. 1080-WW

6 Piece 1/2 dr. Socket Set 15

Sizes: 15, 17, 19, 21, 22, 24 mm.

Specialist Sockets > Wheel Nut Sockets



**CONSUMABLE
PRODUCT**

Not covered by warranty.

Art. 2885-WW

17-mm Impact Socket + Plastic Protector For Mercedes-Benz Models

Specialist Sockets > Wheel Nut Sockets

Specialist socket for use on Mercedes wheel nuts.



Art. 1180-WW

21-mm Impact Socket + Plastic Protector For Mercedes-Benz Models

Specialist Sockets > Wheel Nut Sockets

Specialist socket for use on Mercedes wheel nuts.



Art. 1180-1-WW

Locking Wheel Nut Keys, Master Kit for VAG; 65pcs

Specialist Sockets > Wheel Nut Sockets

For dismantling of the original VAG rim lock sockets with 17 mm hexagonal drive.
 51/6 pt. - 52/7 pt. - 53/8 pt. 55/10 pt. 56/11 pt. - 57/12 pt. - 58/13 pt. 60/15 pt. - 61/16 pt. - 62/17 pt. - ABC0/10 pt. - 1/11 pt. - 2/13 pt. 3/14 pt. - 4/15 pt.



Art. 1322-WW

Locking Wheel Nut Keys, Master Kit for BMW; 42pcs

Specialist Sockets > Wheel Nut Sockets

Designed to fit BMW wheel nuts.
 Applications: 1 Series F20/F21, 3 Series F30/F31, 4 Series F32/F34/F36, 5 Series F10/F11, 6 Series F12/F13 & 7 Series F01/F02/F04.
 Suitable for tyre fitting bays & garages.
 Key Sockets: 11, 12, 13, 14, 15, 16, 17, 18, 19, 20, 31, 32, 33, 34, 35, 36, 37, 38, 40, 41, 42, 43, 44, 45, 46, 47, 48, 49, 50, 51, 52, 53, 54, 55, 56, 57, 58, 59, 60.



Art. 1323-WW

Protective Impact Socket; Heavy Duty, 17 mm

Specialist Sockets > Wheel Nut Sockets

Individual 17mm protective impact socket.
Available in 3101-WW set.



Art. 3101-17-WW

Protective Impact Socket; Heavy Duty, 19 mm

Specialist Sockets > Wheel Nut Sockets

Individual 19mm protective impact socket.
Available in 3101-WW set.



Art. 3101-19-WW

Protective Impact Socket; Heavy Duty, 21 mm

Specialist Sockets > Wheel Nut Sockets

Individual 21mm protective impact socket.
Available in 3101-WW set.



Art. 3101-21-WW

Protective Impact Socket Set; Heavy Duty, 17, 19, 21 mm

Specialist Sockets > Wheel Nut Sockets

Suitable for manual and impact wrench use.
Heavy Duty Design For Longevity.
Plastic cover for perfect protection of aluminium rims.
Groove and hole at base of socket.
Coloured plastic covers help to indicate the right size.
Sockets available separately.
Length 85 mm.



Art. 3101-WW

Torsion Socket; 110mm Long, 17mm, 1/2"

Specialist Sockets > Wheel Nut Sockets

Allow torque of up to 80ft lbs (108Nm).
110mm Long.
1/2" Drive.



Art. 60077-17-WW

Torsion Socket; 110mm Long, 19mm, 1/2"

Specialist Sockets > Wheel Nut Sockets

Allow torque of up to 80ft lbs (108Nm).
110mm Long.
1/2" Drive.



Art. 60077-19-WW

Torsion Socket; 110mm Long, 21mm, 1/2"

Specialist Sockets > Wheel Nut Sockets

Allow torque of up to 80ft lbs (108Nm).
110mm Long.
1/2" Drive.



Art. 60077-21-WW

Torsion Socket Set; 110mm, 17, 19, 21mm, 1/2"

Specialist Sockets > Wheel Nut Sockets

Torsion sockets which allow torque of up to 80ft lbs (108Nm) when used with an air impact wrench.

Prevents the over tightening of wheel nuts.

Manufactured from Chrome Molybdenum.

6-Point Hex sockets.

Please note always use a Torque Wrench to check the torque.

Sizes:

60076-17-WW 17MM.

60076-19-WW 19MM.

60076-21-WW 21MM.



Art. 60077-WW

Protective Impact Socket; Long, 17 mm, 1/2"

Specialist Sockets > Wheel Nut Sockets

Designed for use when working on Alloy Wheels to eliminate the possibility of damage when removing wheel bolts.



Art. 60057-17-WW

Protective Impact Socket; Long, 19 mm, 1/2"

Specialist Sockets > Wheel Nut Sockets

Designed for use when working on Alloy Wheels to eliminate the possibility of damage when removing wheel bolts.



Art. 60057-19-WW

Protective Impact Socket; Long, 21 mm, 1/2"

Specialist Sockets > Wheel Nut Sockets

Designed for use when working on Alloy Wheels to eliminate the possibility of damage when removing wheel bolts.



Art. 60057-21-WW

Protective Impact Socket Set; Long, 17, 19, 21 mm, 1/2"

Specialist Sockets > Wheel Nut Sockets

Designed for use when working on Alloy Wheels to eliminate the possibility of damage when removing wheel bolts.

Sizes: 17, 19, 21 Extra Long 150-mm & Thin Walled.

Applicable use on Air Tools & Torque Wrenches.

Available Separately:

60057-17-WW 17-MM.

60057-19-WW 19-MM.

60057-21-WW 21-MM.



Art. 60057-WW

Locking Wheel Nut Removers

Specialist Sockets > Wheel Nut Sockets

Designed to provide a quick and efficient solution to remove locking wheel nuts when the key is missing or damaged.

The sockets are tapered which when hammered on to the nut grips on to it which in turn allows the nut to be removed by using a breaker bar.

Included sockets (outer diameter): 26, 27, 28, 28.8, 28.9, 30.0, 30.9, 31.8, 34.8, 35.8, 36.8.

Socket wall: 7mm thick.

Not designed to replace original keys.



Art. 2940-WW

Locking Wheel Nut Keys; VAG, 23 pcs

Specialist Sockets > Wheel Nut Sockets

For dismantling of the original VAG rim locks.

Rim lock sockets with 17 mm hexagonal drive.

Includes rim lock sockets in following sizes:

51/6 pt. - 52/7 pt. - 53/8 pt. - 55/10 pt. 56/11 pt. - 57/12 pt. - 58/13 pt. 60/15 pt. - 61/16 pt. - 6.



Art. 4006-WW

Locking Wheel Nut Keys; BMW, 21 pcs

Specialist Sockets > Wheel Nut Sockets

Set of Wheel Nut Locking keys for BMW the pre F type models.

For dismantling of the original BMW rim locks- sockets with 17 mm hexagonal drive- includes rim lock sockets in following sizes: 30/13 pt. - 31/15 pt. - 32/16 pt. - 12/14 pt. 11/15 pt. - 33/17 pt. - 34/16 pt. - 35/19 pt. 16/10 pt. - 15/11 pt. - 14/12 pt. - 36/20 pt. 37/21 pt. - 38/22 pt. - 40/23 pt. - 18/13 pt. 17/7 pt. - 20/9 pt. - 19/8 pt.- 1/2" protective impact socket, 17 mm.



Art. 4007-WW

Locking Wheel Nut Keys; VAG, 10 pcs

Specialist Sockets > Wheel Nut Sockets

For the installation and removal of locking wheel nuts found on VAG group vehicles.

Included: ACB: 0 (10pt), 1 (11pt), 2 (13pt), 3 (14pt), 4 (15pt), 5 (16pt), 6 (17pt), 7(19pt), 8(20pt), 9(21pt).

Applications: Golf, Polo, Sirocco, Jetta, A4, A5, A6.



Art. 4019-WW

Locking Wheel Nut Keys; VAG, 10 pcs

Specialist Sockets > Wheel Nut Sockets

For the installation & removal of locking wheel nuts on BMW vehicles.
 Sizes Include: B11 / 15 ribs, B12 / 14 ribs, B13 / 16 ribs, B14 / 12 ribs, B15 / 11 ribs, B16 / 10 ribs, B17 / 7 ribs, B18 / 13 ribs, B19 / 8 ribs, B20 / 9 ribs.



Art. 4020-WW

Locking Wheel Nut Keys, BMW; OEM

Specialist Sockets > Wheel Nut Sockets

Designed to fit BMW wheel nuts.
 Applications: 1 Series F20/F21, 3 Series F30/F31, 4 Series F32/F34/F36, 5 Series F10/F11, 6 Series F12/F13 and 7 Series F01/F02/F04.
 Included: 20 x keys, 1 x adaptor and 1 x punch.
 Suitable for tyre fitting bays and garages.
 OEM equivalents.



Art. 4034-WW

Locking Wheel Nut Removal Kit; Universal (Large Sizes)

Specialist Sockets > Wheel Nut Sockets

Outer Diameter: 34.8, 35.8, 36.8, 37.8, 38.8, 39.8 mm.
 Inner Diameter: 26.2, 27.4, 28.4, 29.4, 30.4, 31.3 mm.



SINGLE SOCKETS
 Available separately, in single sockets section.



CONSUMABLE PRODUCT
 Not covered by warranty.

Art. 4063-1-WW

Locking Wheel Nut Removal Kit; Universal

Specialist Sockets > Wheel Nut Sockets

Inside Diameter: 19, 20, 21, 21.8, 21.9, 23, 23.9, 24.8, 27.8, 28.8, 29.8, 30.8, 31.8, 32.8mm.
 Outer Diameter: 26mm, 27mm, 28mm, 28.8mm, 28.9mm, 30mm, 30.9mm, 31.8mm, 34.8mm, 35.8mm, 36.8mm, 37.8mm, 38.8mm, 39.8mm.



SINGLE SOCKETS
 Available separately, in single sockets section.



CONSUMABLE PRODUCT
 Not covered by warranty.

Art. 4063-WW

Locking Wheel Nut Master Key Set; 16pcs

Specialist Sockets > Wheel Nut Sockets

Dual head design fits most factory lug wrenches.
Includes all the tuner keys needed to fit most splined lug nuts.
8-point star lug, 7/16" outer.
6-spline small Ø socket, 41/64" inner.
5-spline small Ø socket, 5/8" inner.
8-point star lug, 5/8" outer.
9-point socket style tuner lug nuts.
High tech fluted hex lug, 12mm outer.
0-point star lug, 1/2" outer.
High tech hex lug, 12mm outer.
12-spline small Ø socket, 11/16" inner.
7-spline small Ø socket, 5/8" inner.

7-spline small Ø duplex socket, 3/4" inner.
High tech hex lug, 9/16" outer.
High tech hex lug, 15mm outer.
6-spline small Ø socket, 45/64" inner.



Art. 4122-WW

Locking Wheel Nut Keys, VAG; OEM

Specialist Sockets > Wheel Nut Sockets

Dual head design allows for fitting on must lug wrenches.
Cold forged and heat treated allows for a longer life.
Includes multiple keys to fit on a variety of VAG Group vehicles.
Must have for any garage or workshop.
All parts are OEM.



Art. 4185-1-WW

Locking Wheel Nut Keys, VAG; OEM

Specialist Sockets > Wheel Nut Sockets

Dual head design allows for fitting on must lug wrenches.
Cold forged and heat treated allows for a longer life.
Includes multiple keys to fit on a variety of VAG Group vehicles.
Must have for any garage or workshop.
All parts are OEM.



Art. 4185-2-WW

Locking Wheel Nut Keys, Mercedes; OEM, 12pcs

Specialist Sockets > Wheel Nut Sockets

Applications: A Class, B Class, C Class, GLK Class, CLC Class, CLS Class, CLK Class, E Class, SL Class, SLK Class, M Class, C300, C250, C350, E320, 204, 211, 212, R Class.
Sizes: M12 x 1.5 x 40mm.
M14 x 1.5 x 26mm / 26.5mm / 46mm / 45mm.



Art. 4186-WW

Locking Wheel Nut Removers

Specialist Sockets > Wheel Nut Sockets

1/2" SQ DR:
 50.8L (Ø27xØ26.4).
 57L (Ø27).
 57L (Ø31.5).
 66L (Ø31.5).
 Hex DR:
 50.8L (Ø16xØ10.7).
 50.8L (Ø16xØ13xØ8.4).
 50.8L (Ø18.6xØ14.1).
 50.8L (Ø21.5xØ18.4xØ16).



Art. 1050-WW

Locking Wheel Nut Key Set for Porsche, 20 Piece

Specialist Sockets > Wheel Nut Sockets

OEM T10190.
 ABC-50, ABC-51, ABC-52, ABC-53, ABC-54.
 ABC-55, ABC-56, ABC-57, ABC-58, ABC-59.
 ABC-60, ABC-61, ABC-62, ABC-63, ABC-64.
 ABC-65, ABC-66, ABC-67, ABC-68, ABC-69.



Art. 8002-WW

Locking Wheel Nut Key Set for Audi, 20 Piece

Specialist Sockets > Wheel Nut Sockets

Key sockets: 801, 802, 803, 804, 805, 806, 807, 808, 809, 810, 811, 812, 813, 814, 815, 816, 817, 818, 819, 820.



Art. 8003-WW

Locking Wheel Nut Keys; BMW/MINI, 10 pcs

Specialist Sockets > Wheel Nut Sockets

Designed for the install and removal of spline styles BMW locking wheel nuts.
 To be used with a 17mm socket.
 Sizes: 13pt (30), 15pt (31), 16pt (32), 17pt (33), 18pt (34), 19pt (35), 20pt (36), 21pt (37), 22pt (38), 23pt (40).
 Application: Early F type BMW and Mini models.
 OEM: 36 1 335.



Art. 4018-WW

Locking Wheel Nut Removal Sockets

Specialist Sockets > Wheel Nut Sockets

For the quick and easy removal of wheel rim locks.
Used for almost all current wheel lock systems.
6-point rod: 17mm x 180mm and 22mm x 180mm.
Force Socket: 18mm, 19mm, 20mm, 21mm, 22mm, 23mm, 24mm, 25mm.
10 piece set.



**CONSUMABLE
PRODUCT**
Not covered by warranty.

Art. 800071-UTC

Locking Wheel Nut Keys, Volvo; B-Type, 20 pcs

Specialist Sockets > Wheel Nut Sockets

A set of OEM locking wheel nut sockets for the Volvo range.
Content: 944L, 945L, 946L, 947L, 948L, 949L, 950L, 951L, 952L, 953L, 065L, 071L, 072L, 076L, 079L, 121L, 651L, 944P, 945P, 951P.



Art. 60076-WW

Locking Wheel Nut Keys, Opel/Vauxhall; OEM, 12pcs

Specialist Sockets > Wheel Nut Sockets

12 piece locking wheel nut set for Opel / Vauxhall models in protective hard case.
Key fittings: 102B, 111M, 183C, 186F, 188H, 191M, 193P, 194Q, 195R, 198V, 199X, 200Z.



Art. 5004-WW

Locking Wheel Nut Keys, Land Rover; OEM, 10pcs

Specialist Sockets > Wheel Nut Sockets

Landrover OEM Locking Wheel Nut Sockets, For Use On: Land Rover Discovery 1/2, Defender & Range Rover OEM codes: OEM, STC3420/A, STC3420/B, STC3420/C, STC3420/D, STC3420/E, STC3420/F, STC3420/G, STC3420/H, STC3420/I, STC3420/



Art. 7034-WW

Locking Wheel Nut Removal Kit; Universal, 26.0-31.8

Specialist Sockets > Wheel Nut Sockets

Outer Diameter: 26.0, 27.0, 28.0, 28.9, 30.0, 30.9, 31.8, 31.9.

Inner Diameter: 8, 19, 20, 20.8, 20.9, 21.7, 22.8, 23.8.

Easily remove locking wheel nuts with a near universal list of applications.

Special conical shaped design allows the sleeve to fit over the nut and through hammer impacts the sleeve and the nut wedges together to be removed with a breaker bar or impact wrench.

Alternatively Art. 1158-11 can be used with the 1070 vibro hammer for more impact force.



**CONSUMABLE
PRODUCT**
Not covered by warranty.



SINGLE SOCKETS

Available separately, in single sockets section.

Art. 1158-WW

Locking Wheel Nut Removal Kit; Universal (Vibration Edition)

Specialist Sockets > Wheel Nut Sockets

Sizes: 26.0, 27.0, 28.0, 28.9, 30.0, 30.9, 31.8, 31.9.

Easily remove locking wheel nuts with a near universal list of applications.

Special conical shaped design allows the sleeve to fit over the nut and through hammer impacts the sleeve and the nut wedges together to be removed with a breaker bar or impact wrench.

Designed to be used with the 1070-ww vibro hammer thanks to the special adapter.

Exclusive to Welzh Werkzeug.



**CONSUMABLE
PRODUCT**
Not covered by warranty.



SINGLE SOCKETS

Available separately, in single sockets section.

Art. 1158-11-WW

Hex Driver from 1158-WW; 22mm.

Specialist Sockets > Wheel Nut Sockets

Sizes: 26.0, 27.0, 28.0, 28.9, 30.0, 30.9, 31.8, 31.9.

Easily remove locking wheel nuts with a near universal list of applications.

Special conical shaped design allows the sleeve to fit over the nut and through hammer impacts the sleeve and the nut wedges together to be removed with a breaker bar or impact wrench.

Designed to be used with the 1070-ww vibro hammer thanks to the special adapter.

Exclusive to Welzh Werkzeug.



Art. 1158-10-WW.

Hex Driver from 1158-WW, 17mm.

Specialist Sockets > Wheel Nut Sockets

Sizes: 26.0, 27.0, 28.0, 28.9, 30.0, 30.9, 31.8, 31.9.

Easily remove locking wheel nuts with a near universal list of applications.

Special conical shaped design allows the sleeve to fit over the nut and through hammer impacts the sleeve and the nut wedges together to be removed with a breaker bar or impact wrench.

Designed to be used with the 1070-ww vibro hammer thanks to the special adapter.

Exclusive to Welzh Werkzeug.



Art. 1158-9-WW.

3-Piece Drive Shaft Splines M8 M10 M12

Specialist Sockets > Drive Shaft Socket

Suitable for drive shaft screws.
 No need for (several) extension bars.
 Suitable for VW and other brands.
 M8 x 800 mm, M10 and M12 x 800 mm x 800 mm.



Art. 1064-WW

Drive Shaft Socket Set 30, 32, 36 mm

Specialist Sockets > Drive Shaft Sockets

Int. Hex: 14 - 17 - 19 mm.
 Sizes: 30 - 32 - 36 mm.
 12-pt Sockets.
 Available Separately:
 60070-30-WW.
 60070-32-WW.
 60070-36-WW.



Art. 1077-WW

Hub Nut Socket for Ford Transit 2014 onward; Rear

Specialist Sockets > Drive Shaft Sockets

Alignment tube required to ensure the socket works directly onto the slotted nut.
 Required for the rear Hub Nuts on Ford Transit 2014>Hex drive 19mm.
 Equal to OEM 205-1007.



Art. 4060-WW

Drive Shaft Sockets; 12pt, 24, 30, 32, 36, 46mm

Specialist Sockets > Drive Shaft Sockets

Sizes: 24, 30, 32, 36, 46 mm (sockets).
 Sizes: 14, 17, 19 mm (bits).
 12pt profile.
 1/2" drive.
 Specially design for use on hub nuts.



Art. 4183-WW

Drive Shaft Socket; 12pt, 46mm

Specialist Sockets > Drive Shaft Sockets

For use on 46mm drive shafts.
Applications: Renault Master and Vauxhall Movano.
1/2" square drive.
12 point profile.
Can be used with impact drivers.



Art. 4184-WW

Hub Nut Socket for Ford Transit; 12pt, 56 mm

Specialist Sockets > Drive Shaft Sockets

Ford Transit Hub Nut Socket.
Size: 56MM.



Art. 4209-WW

Hub Nut Socket for Ford Transit; 12pt, 65 mm

Specialist Sockets > Drive Shaft Sockets

Ford Transit hub nut socket.
Size: 65MM.



Art. 4210-WW

Hub Nut Socket for Ford Transit; 12pt, 50 mm

Specialist Sockets > Drive Shaft Sockets

Ford Transit hub nut socket.
Size: 50MM.



Art. 4211-WW

Glow Plug Sockets; Universal Joint, 3/8"

Specialist Sockets > Other Specialist Sockets

3/8" drive, sizes 8, 9, 10, 12, 14, 16 mm.
 Glow plugs are held by retaining ball.
 Universal joint allows for easy access to awkward areas.
 Length 75 mm / 80 mm (14 + 16 mm).
 Depth of 6-pt. 8 mm.



Art. 1081-WW

Mercedes Diesel Injection Socket 33-Toothed

Specialist Sockets > Other Specialist Sockets

For fuel injection pump of diesel vehicles.



Art. 1140-WW

Oxygen Sensor Socket; 22 mm (7/8") x 50 mm; 1/2" drive

Specialist Sockets > Other Specialist Sockets

For assembly of oxygen/lambda sensors, radiator thermo switch and Diesel injection nozzles.



Art. 1152-22-WW

7-Piece Oxygen Sensor Sockets

Specialist Sockets > Other Specialist Sockets

3/8" and 1/2" drive.
 For assembly of oxygen/lambda sensors, radiator thermo switch and Diesel injection nozzles.
 Sizes:
 29 x 90 mm, 1/2" drive.
 7/8" x 90 mm, 3/8" drive.
 7/8" x 50 mm, 1/2" drive.
 27 x 78 mm (12-pt.), 1/2" drive.
 7/8" x 90 mm, 3/8" drive.
 7/8" offset, 3/8" drive.
 7/8" 12-pt.offset, 1/2" drive.



Art. 1152-WW

Tap Socket Set; 8pcs

Specialist Sockets > Other Specialist Sockets

Using the more traditional T-piece type tap holders whilst working with new threads can cause difficulty in restricted work areas. These tap sockets allow for easier use with 1/4" & 3/8" drive whilst cutting, chasing & cleaning threads. The sockets are made with chrome vanadium ensuring quality & strength which are also magnetic for secure hold to taps.



Art. 1903-WW

PSG Glow Plug Insert Socket Set 6pcs

Specialist Sockets > Other Specialist Sockets

Design for the safe removal of PSG glow plugs.
Can be used on normal glow plugs also.
Supplied with 5 insulating caps.
Special inner bearings allow safe gripping of the glow plugs.
Applications:
Audi: A3, A4, A5, A6, A7, A8, Q5, Q7.
VW: Polo (6R/6C), Golf VI +VII, Jetta III + IV, Beetle, Touareg.
Skoda: Octavia.
SEAT: Leon.
Opel: Astra J, Corsa D, Insignia, Meriva, Zafira D.



Art. 4004-WW

Spreader Socket Set for Spring Strut Clamp, 5 x 7 mm and 5.5 x 8.2 mm

Specialist Sockets > Other Specialist Sockets

Sizes Included: 5x7mm, 5.5x8.2mm.
For spreading spring strut clamps on VAG, BMW, Citroen, Ford and Renault wheel house bearings.
Drive: 1/2".



Art. 4016-WW

Socket Set for use with Air Hammer (Vibration Impact)

Specialist Sockets > Other Specialist Sockets

Designed to loosen and remove stuck, seized and rusted fixings (bolts, screws, etc.).
To be used with vibration hammers. Works with item 1070-WW.
Suitable for use with a wide range of fixings including bolts, screws, nuts, glow plugs & more.
The go-through flex head ratchet wrench allows for easy application of torque.
7-Piece 6pt Deep Impact Sockets includes: 8, 9, 10, 11, 12, 13, 14mm.



Art. 4093-WW

Impact Vibration Glow Plug Removal Gun Incl Sockets 8-12 mm

Specialist Sockets > Other Specialist Sockets

The impact wrench is designed to deliver low torque in 4 stages (10, 20, 30, 40 nm).
 The use on vibrations and torque will allow easy removal of stuck glow plugs.
 The level of torque will stop the shearing of the glow plug head.
 Impact Gun: 20 to 40nm.
 Deep Sockets: 8, 9, 10, 11, 12 mm.
 Extension Bars 50 & 100mm.
 Universal Joint.
 1/4" Drive.



Art. 4121-WW

Flexible Socket For Suspension Bolts On VAG Group

Specialist Sockets > Other Specialist Sockets

Specialist tool designed to be used when removing the top of Macpherson strut mounts. Which are commonly found on Audi, SEAT, Skoda and VW vehicles.
 The fixtures are found in a confined area which makes access awkward via traditional methods. Although in a confined area the nuts are prone to corrosion and damage which means replacement and servicing is often needed.
 Our product has been uniquely designed to access the strut mount with minimal effort due to the flexible design.
 The factory OEM nuts can either be 6 or 8 point, due to the dual sided socket 4130-WW can accommodate both.
 3/8" drive - should be used with an extension bar (80 mm).



Art. 4130-WW

Socket For Porsche, Audi Q7 Brake Calipers; 10-PT

Specialist Sockets > Other Specialist Sockets

For use on the brake pad screw for Porsche AUDI Q7 VW TOUAREG.
 10-Point Brake Caliper Socket.



Art. 4190-WW

Common Rail Diesel Injector Repair Sockets

Specialist Sockets > Other Specialist Sockets

Must have when working on Common Rail engines.
 This kit includes special tools to remove the injectors internal fixings.
 Suitable for use on Bosch, Denso and Siemens injectors.
 Includes:
 3 x injector ball valve lapping tools.
 Internal fixing removal tool for Common Rail injectors.
 8 side socket for Bosch Common Rail engines.
 Denso CR injector valve seat removal tool.
 10 x 7.6 mm hex bit.



Art. 4197-WW

Specialist Automotive Sockets 10-Piece

Specialist Sockets > Other Specialist Sockets

10S, 6pt., for Toyota idle wheel centre screw.
6S, 6pt., for Nissan & Renault clutch.
8S, 6pt., for Nissan cylinder head & balance shaft.
12S, 6pt., for Nissan cylinder head.
8TS, 3pt., for Nissan balance shaft.
10 mm, 5pt., for brake systems.
12 mm, 5pt., for Nissan fuel pump.
14 mm, 5pt., for GM & Smart Car.
19 mm, 5pt., for Peugeot, Renault & Citroen parking brake.
20 mm, 10pt., for Honda Civic lower control arm.
Length: 38 mm.



Art. 60028-WW

Thin Walled Lambda Sensor Socket 22mm - Ford

Specialist Sockets > Other Specialist Sockets

For use on the shrouded Lambda sensor sensors found on Ford Fiesta 1.25 from 2008 to 2016.
Allows Access to the Lambda Sensor which is hampered by a tight fitting heat shield.
Slotted 22mm x 119mm long x 1/2"Dr Lambda socket.



Art. 60063-WW

Socket for DPF Sensors On Landrovers Models

Specialist Sockets > Other Specialist Sockets

Designed for modern Jaguar and Land Rover engines fitted with exhaust particulate filtration systems (DPF).
Applications: Range Rover (L322-2011-2012), Range Rover (L405-2013, 2014, 2015, 2016, 2017), Range Rover; Sport (L494-2014, 2015, 2016, 2017).
Remove and install the gas temperature sensor in the exhaust.
OEM equivalent: 303-1573.
Specs: 13 mm (12 pt) with slot, can be used with a 13 mm socket or spanner.



Art. 60079-WW

Exhaust Gas Temperature Sensor Sockets 6-Piece Kit

Specialist Sockets > Other Specialist Sockets

The 3 different sizes, 13mm, 14mm & 17mm.
This set of sockets is designed to remove most EGT sensors used on cars, light, medium, & heavy-duty trucks.
Designed to drive all 6 sides of the hex equally to reduce the chance of damage.



Art. 7070-WW

Porsche 911 Carrera 4 GTS Socket for Center Wheel Lock Nut

Specialist Sockets > Other Specialist Sockets

Porsche 911 Carrera 4 GTS Socket for Center Wheel Lock Nut Porsche 2012 911 Carrera 4 GTS 2011-2012 911 Carrera GTS 2008-2009 911 GT2 2011 911 GT2 RS 2010-2011 911 GT3 2014-2015 911 GT3 2011 911 GT3 RS 2011 911 GT3 RS 4.0 2007-2015 911 Turbo 2011-2015 911 Turbo S.



Art. 8050-WW

11-Piece 3/8" Anti Skid Socket Set

Specialist Sockets > Extractor Sockets

Impact proof screw and stud extractors for removing damaged and rounded bolts, wheel nuts or locking wheel nuts.

Sizes: 8, 9, 10, 11, 12, 13, 14, 15, 16, 17 and 19 mm.
3/8" drive.



Art. 1085-WW

1/4dr Long Twisty Sockets

Specialist Sockets > Extractor Sockets

For turning off the electrodes.

Includes turn off sockets: 2.6 - 3.2 - 3.5 - 4.5 - 6.5 - 8.25 mm.



Art. 1106-WW

Twist Sockets 27, 30, 32, 33, 34, 36mm, 3/4"

Specialist Sockets > Extractor Sockets

Designed to remove damaged or rounded bolts.

3/4" drive.

Sizes: 27, 30, 32, 33, 34, 36 mm.

Can be used with air tools.

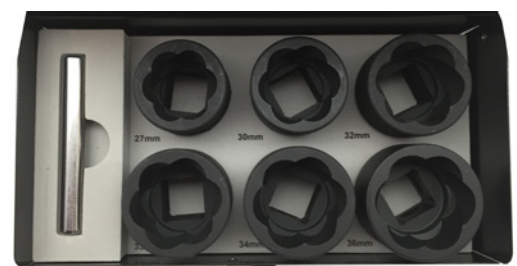

Art. 4045-WW

Twist Socket Set; 3/8", 10-19 mm

Specialist Sockets > Extractor Sockets

Black bronzed surface.
 For loosening damaged screws and nuts.
 Suitable for impact screwdrivers.
 The innovative spiral profile digs itself into the head of a damaged screw/nut and thereby allows you to loosen it securely.
 Sizes: 10-11-12-13-14.



Art. 4090-WW

17-Piece Screw And Stud Extractor Set

Specialist Sockets > Extractor Sockets

Designed to remove damaged screws and nuts also rusted and rounded bolts.
 Included:
 5 screw extractors.
 4 Stud sockets (6, 8, 19, 12 mm).
 Sockets 9, 10, 11, 12, 13, 14, 16, 19 mm.
 3/8" drive.



Art. 4113-WW

8-Piece Universal Impact Adaptor Set + Universal Joints

Specialist Sockets > Extractor Sockets

Impact proof reducer and converter set for 1/4, 3/8, 1/2 and 3/4 drive.
 Included:
 Universal Joint 3/8 & 1/2.
 Converter 3/8f to 1/2m.
 Reducer 1/2f to 3/8m.
 Converter 1/2f to 3/4m.
 Reducer 3/4f to 1/2m.
 Converter 3/8f to 1/4m.
 Reducer 1/4f to 3/8m.



Art. 4135-WW

Twist Sockets; Extra Long, 17, 19, 21 mm, 1/2"

Specialist Sockets > Extractor Sockets

The innovative spiral profile digs itself into the head of a damaged screw/nut and thereby allows to loosen it securely.
 Suitable for impact wrenches.
 Sizes: 17, 19, 21.
 Includes Tommy bar.
 1/2" drive.



Art. 4151-WW

Twist Socket Set; Long, 17, 19, 21, 22 mm, 1/2"

Specialist Sockets > Extractor Sockets

The innovative spiral profile digs itself into the head of a damaged screw/nut and thereby allows to loosen it securely.
Suitable for impact wrenches.
Sizes: 17, 19, 21, 22.
Includes Tommy bar.
1/2" drive.



Art. 60065-WW

Extractor Set for Screws (25 pcs)

Specialist Sockets > Extractor Sockets

Allows removal of screws with damaged heads.
Suitable for Allen, T-Star & Spline Screws.
Extractors with 6pt Sizes:

1/8" (3.2mm) 5/32" (4mm) 3/16" (4.8mm) 7/32" (5.5mm) 1/4" (6.3mm) 9/32" (7mm) 5/16" (8mm)
11/32" (8.7mm) 3/8" (9.5mm) 13/32" (10.3mm) 7/16" (11.1mm) 15/32" (11.9mm) 1/2" (12.7mm)
17/32" (13.4mm) 9/16" (14.3mm) 19/32" (15.1mm) 5/8" (15.9mm) 21/32" (16.7mm) 11/16" (17.5mm)
23/32" (18.3mm) 3/4" (19.1mm) 25/32" (19.8mm) 13/16" (20.6mm) 27/32" (21.4mm) 7/8" (22.2mm)



Art. 7020-WW

8-Piece Lok-Typ Torx Removers

Specialist Sockets > Extractor Sockets

Special design of Torx plus head, twist body with teeth and tap shape.
High efficiency to remove damaged objects in a wide range of applications:
Stripped Torx / Torx plus / Torx security inside.
Torx / Torx plus / Torx security inside.
Hex inside (not stripped).
Stripped round inside.
Stripped hex inside.
Round inside.

Replacement parts:

7453-3-ww: 3-mm Lok-Typ Torx Remover.
7453-4-ww: 4-mm Lok-Typ Torx Remover.
7453-5-ww: 5-mm Lok-Typ Torx Remover.
7453-6-ww: 6-mm Lok-Typ Torx Remover.
7453-7-ww: 7-mm Lok-Typ Torx Remover.
7453-8-ww: 8-mm Lok-Typ Torx Remover.
7453-10-ww: 10-mm Lok-Typ Torx Remover.
7453-12-ww: 12-mm Lok-Typ Torx Remover.



Art. 7453-WW

Twist Sockets; 9-19mm, 3/8"

Specialist Sockets > Extractor Sockets

Designed to remove damaged screws and bolts when damaged or rounded. Suitable for use on an impact wrench.
Sizes: 10, 11, 12, 13, 14, 15, 16, 17, 19 mm.



Art. 800050-UTC

10-Piece Screw Extractor Set 3-11mm

Specialist Sockets > Extractor Sockets

These Hex head multi-spine extractors can allow the removal of broken studs, pipes, set screws, grease fittings, etc.

Can be used with hand sockets and wrenches.

Sizes: 1/8" - 5/32" - 3/16" - 7/32" - 1/4" - 9/32" - 5/16" - 11/32" - 3/8" - 13/32".



Art. 8013-WW

Universal Stud Extractor 6-12 MM

Specialist Sockets > Extractor Sockets

Allows a fast dismantling and mounting of studs.

Chuck is suitable for 6 - 12 mm studs.

Drive: 24 mm Wrench or 1/2" Ratchet.

36 mm 6-pt. Chuck.



Art. 800074-UTC

5-Piece Oil Filter Tool Sockets

Specialist Sockets > Oil Filter Sockets

For loosening oil filter housing, with slim profile suitable for confined spaces.

Sizes: 24, 27, 32, 36, 38 mm.

3/8" Drive.



Art. 1151-WW

5-Piece Low Profile Oil Filter Sockets

Specialist Sockets > Oil Filter Sockets

Sizes: 24mm, 27mm, 32mm, 36mm, 38mm.

27mm for Mercedes A Class.

32mm for Gm/Opel/Vauxhall, Astra G, Corsa B, Zafira.

36mm for BMW, Ford: Mondeo 2.0D Duratorq, Transit 2.0 & 2.5 Duratorq, GM Omega, Vectra B, Zafira (98on), Mercedes, Vito CDI.

38mm for Vauxhall Vectra 2.0D.



Art. 802-UTC

14 mm Spark Plug Socket; 12-point; 3/8"; Length 90 mm With Magnet

Specialist Sockets > Spark Plug Sockets

Magnetic inside for holding the spark plug for removal.
18.5 mm outside diameter.
Thin walled.
12pt.



Art. 1185-WW

Spark Plug Socket 14MM With Retaining Ring

Specialist Sockets > Spark Plug Sockets

Suitable for use with air tools.
12-point.



Art. 4101-WW

Spark Plug Socket 14mm

Specialist Sockets > Spark Plug Sockets

Specifically for use on Ford Ecoboost 1.5 engines.
Manufactured from Chrome Vanadium.
Bi-Hex profile.
180mm long.



Art. 60043-WW

Impact Power Hand Impact Wrench

Torque Tools > 1/2" Torque Wrench

Will work where normal air impact wrenches won't fit such as under the bonnet.
Allows access to restricted areas under the bonnet.
1/2" push through.
600ft/lb Torque.



Art. 1156-WW



S2 STEEL SOCKETS

LIFETIME WARRANTY



Socket and Bit Master Set; Torx®, S2 Steel

Bit Socket Assortments > Torx Bit Assortments

Torx:
T6, T8, T10, T15, T20, T25, T27, T30, T40, T45, T55, T60, T70.
Torx Plus:
T8H, T10H, T15H, T20H, T25H, T27H, T30H, T40H, T45H, T50H, T55H, T60H.
Tamper Proof Torx:
8IP, 10IP, 15IP, 20IP, 25IP, 27IP, 30IP, 40IP, 45IP, 50IP, 55IP, 60IP.
E-Torx:
E4, E5, E6, E7, E8, E10, E12, E14, E16, E18, E20, E22, E24.
Suitable for use with air tools.
Made from impact resistant S2 steel.



Art. 1165-WW

Bit Socket Set; Torx Set® T6-T70 110mm Length S2 Zinc Steel

Bit Socket Assortments > Torx Bit Assortments

1/4" DR: T6, T8, T10, T15, T20, T25, T27, T30.
3/8" DR: T40, T45, T47, T50, T55.
1/2" DR: T60, T70.

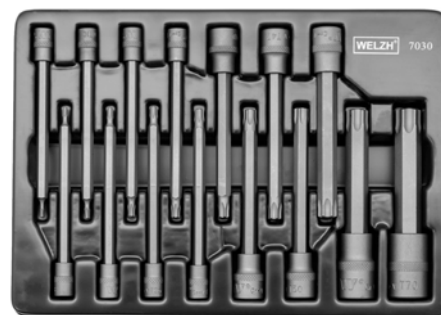

Art. 7030-WW

Bit Socket Set; Master Hex Bit Set 110 mm Length S2 Zinc Steel

Bit Socket Assortments > Hex Bit Assortments

1/4" DR: H2, H2.5, H3, H4, H5, H5.5, H6.
3/8" DR: H7, H8, H9, H10, H12.
1/2" DR: H14, H15, H17, H19, H22.

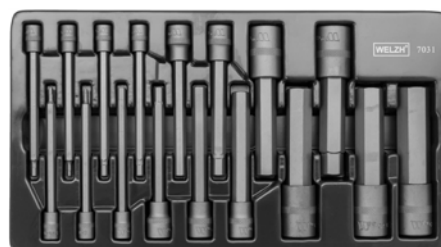

Art. 7031-WW

Bit Socket Set; Master Spline Bit Set 110 mm Length

Bit Socket Assortments > Ribe Spline Assortments

1/4" DR: M4, M5, M6.
 3/8" DR: M7, M8, M9, M10.
 1/2" DR: M12, M13, M14, M16, M18.

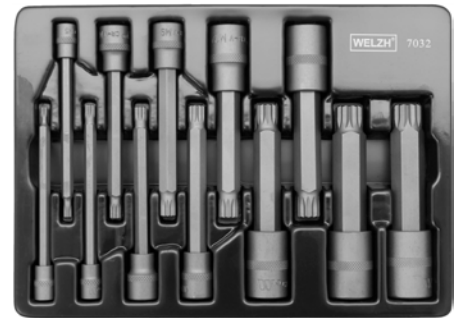

SINGLE SOCKETS

Available separately, in single sockets section.

Art. 7032-WW

Bit Socket Set; Master Ribe Set 110 mm Length

Bit Socket Assortments > Ribe Bit Assortments

1/4" DR: RM4, RM5, RM6.
 3/8" DR: RM7, RM8, RM9, RM10.
 1/2" DR: RM12, RM13, RM14.



Art. 7033-WW

Bit Socket Master Set; 17pcs

Bit Socket Assortments > Mixed Bit Assortments

Made from S2 steel.
 Suitable for use with impact wrenches.
 H2 Bit Socket 1/4dr.
 H2.5 Bit Socket 1/4dr.
 H3 Bit Socket 1/4dr.
 H4 Bit Socket 1/4dr.
 H5 Bit Socket 1/4dr.
 H5.5 Bit Socket 1/4dr.
 H6 Bit Socket 1/4dr.
 H7 Bit Socket 3/8dr.
 H8 Bit Socket 3/8dr.
 H9 Bit Socket 3/8dr.
 H10 Bit Socket 3/8dr.
 H12 Bit Socket 3/8dr.

H14 Bit Socket 1/2dr.
 H15 Bit Socket 1/2dr.
 H17 Bit Socket 1/2dr.
 H19 Bit Socket 1/2dr.
 H22 Bit Socket 1/2dr.



SINGLE SOCKETS

Available separately, in single sockets section.

Art. 4041-WW

Bit Socket Master Set; Spline, 12pcs

Bit Socket Assortments > Bit Sockets

Made from s2 steel suitable for use with impact wrenches.
 1/2" M12, 13, 14, 16, 18.
 3/8" M7, 8, 9, 10.
 1/4" M4, 5, 6.



SINGLE SOCKETS

Available separately, in single sockets section.

Art. 4054-WW

Socket Set, Torx Bits®, S2 Steel, T6-T70

Bit Socket Assortments > Torx Bit Assortments

Made from impact resistant S2 steel.
T6, T8, T10, T15, T20, T25, T27, T30, T40, T45, T55, T60, T70.



Art. 1165-1-WW



SINGLE SOCKETS

Available separately, in single sockets section.

Socket Set, Torx® Plus Bits, S2 Steel, 8IP-60IP

Bit Socket Assortments > Torx Bit Assortments

Made from impact resistant S2 steel.
T8H, T10H, T15H, T20H, T25H, T27H, T30.



Art. 1165-2-WW



SINGLE SOCKETS

Available separately, in single sockets section.

12-piece Tamper Torx Set T8H-T60H S2 Zinc Steel

Bit Socket Assortments > Mixed Bit Assortments

Made from impact resistant S2 steel.
8IP, 10IP, 15IP, 20IP, 25IP, 27IP, 30IP, 40IP, 45IP, 50IP, 55IP, 60I.



Art. 1165-3-WW



SINGLE SOCKETS

Available separately, in single sockets section.

Socket Set, Torx®; 3/8", E4-E24, S2 Steel

Bit Socket Assortments > Torx Bit Assortments

Made from impact resistant S2 steel.
E4, E5, E, E7, E8, E10, E12, E14, E16, E18, E20, E22, E24.



Art. 1165-4-WW



SINGLE SOCKETS

Available separately, in single sockets section.

Bit Socket Set; 3/8dr Torx Set 48mm T20-T45

Bit Socket Assortments > Torx Assortments

Socket Material: (Zinc Phosphate).
 Bit Material: S2 (Zinc Phosphate) 48mm(L).
 Size: T20, T25, T27, T30, T40, T45.
 6 piece set, 3/8"dr.



SINGLE SOCKETS

Available separately, in single sockets section.

Art. 7037-WW

Hex Key Set; 48 mm, H3-H10

Screwdrivers and Key Sets > Key Sets

7 piece set, 3/8"dr 48mm(L).
 Size: H3, H4, H5, H6, H7, H8, H10.
 Socket material: (zinc phosphate).
 Bit material: S2 (zinc phosphate).



SINGLE SOCKETS

Available separately, in single sockets section.

Art. 7038-WW

Bit Socket Set; 3/8dr Ball Allan Key Set 48mm HB3-HB10

Bit Socket Assortments > Hex Bit Assortments

Sizes: HB3, HB4, HB5, HB6, HB7, HB8, HB10.
 Socket material: (zinc phosphate).
 Bit material: s2 (zinc phosphate).
 7 peice set: 3/8"dr 48mm(L).



SINGLE SOCKETS

Available separately, in single sockets section.

Art. 7039-WW

Bit Master Set; 81 pcs (S2 Steel)

Bit Socket Assortments > Mixed Bit Assortments

Torx Bit Socket:

1/4: T6, T8, T10, T15, T20, T25, T27, T30.

3/8: T40, T47, T50, T55.

1/2: T60, T70.

Torx Plus Bit Socket:

1/4: TP8, TP10, TP15, TP20, TP25, TP27, TP30.

3/8: TP40, TP45, TP50, TP55.

1/2: TP60.

Torx External Socket:

1/4: E4, E5, E6, E7, E8.

3/8: E10, E12, E14, E16.

1/2: E18, E20, E22, E24.

Torx Resistant Socket:

1/4: TT8, TT10, TT15, TT20, TT25, TT27, TT30.

3/8: TT40, TT45, TT50, TT55.

1/2: TT60.

Hex Bit Socket:

1/4: H2, H2.5, H3, H4, H5, H5.5, H6.

3/8: H7, H8, H9, H10, H12.

1/2: H14, H15, H17, H19, H22.

Spline Bit Socket:

1/4: M4, M5, M6.

3/8: M7, M8, M9, M10.

1/2: M12, M13, M14, M16, M18.



Art. 5015-WW

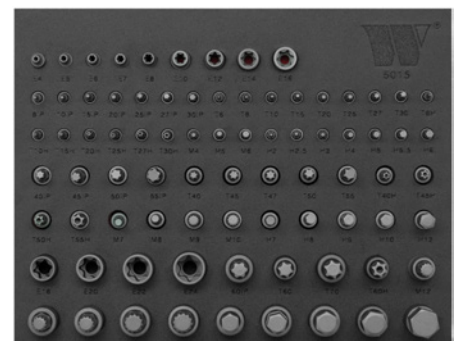

Bit Socket Set; 3/8dr Extra Long Torx Set 110mm T20-T45

Bit Socket Assortments > Torx Bit Assortments

3/8"dr Extra Long Torx Set 110mm T20-T45.



Art. 7023-1-WW



SINGLE SOCKETS

Available separately, in single sockets section.

Bit Socket Set; 3/8dr Extra Long Allan Key Set 110mm H3-H10

Bit Socket Assortments > Hex Bit Assortments

Includes: H3, H4, H5, H6, H7, H8, H10.
Allan key head.
110mm Long.
3/8" square drive.



Art. 7023-2-WW



SINGLE SOCKETS

Available separately, in single sockets section.

Bit Socket Set; 3/8dr Extra Long Ball Allan Key Set 110mm HB3-HB10

Bit Socket Assortments > Hex Bit Assortments

Includes: H3, H4, H5, H6, H7, H8, H10.
Ball Allan key head.
110mm Long.
3/8" square drive.



Art. 7023-3-WW



SINGLE SOCKETS

Available separately, in single sockets section.

Bit Socket Set; 3/8dr Extra Long Spline Set 110mm M4-M10

Bit Socket Assortments > Spline Bit Assortments

Sizes: M4, M5, M6, M7, M8, M9, M10.
Length: 110 mm.
3/8" Drive.



Art. 7023-4-WW



SINGLE SOCKETS

Available separately, in single sockets section.

Bit Socket Set; Extra Long Torx, Hexagon, Ball-Ended Hexagon 110mm

Bit Socket Assortments > Mixed Bit Assortments

Size: HB3, HB4, HB5, HB6, HB7, HB8, HB10.
Size: T20, T25, T27, T30, T40, T45.
Size: H3, H4, H5, H6, H7, H8, H10.
Socket: 50BV30 zinc phosphate.
Bit: S2 zinc phosphate.
Length: 100mm.
3/8" Drive.



Art. 7023-WW



SINGLE SOCKETS

Available separately, in single sockets section.

WRENCHES



Torque Wrench 1/2"Dr 40-200NM Digital With Angle Settings

Torque Tools > 1/2" Torque Wrench

Professional workshop grade torque wrench suitable for daily use. Includes a built in LCD read out with LED, sound and vibration alarms to indicate correct torque levels. Designed with an angle mode making angle gauges redundant saving time and producing accurate results. Cumulative angle measurements for use when space is limited. Space for up-to 5 user presets. Reversible with 72tooth ratchet. Supplied with test certificate. Torque: 40 - 200 Nm. Length: 405 mm. Drive 1/2". Angle Range 0-360°.

Accuracy: +/- 2%.
Resolution: 0.1Nm (0.1lb-ft).
Preset: 10.
Memory (Torque): 100 (10 per angle).
Memory (Angle): 50.
Measurements Unit: (Nm. Lb-ft. In-ft. Kg-m).
Mode: Trace / Peak.
Indicators: LED & Buzzer.
Battery 3pcs * AAA.
Auto shut off: 60seconds.
Operating ambient temperature: 10°C-60 °C
°F-139.9 °F).
Storage temperature: -20 °C -70 °C (-4 °F-57.9 °F).
Operating relative humidity: 15-90% non-condensing.

Art. 8057-WW



Torque Wrench 1/2"Dr 68-340NM Digital With Angle Settings

Torque Tools > 1/2" Torque Wrench

Professional workshop grade torque wrench suitable for daily use. Includes a built in LCD read out with LED, sound and vibration alarms to indicate correct torque levels. Designed with an angle mode making angle gauges redundant saving time and producing accurate results. Cumulative angle measurements for use when space is limited. Space for up-to 5 user presets. Reversible with 72tooth ratchet. Supplied with test certificate. Torque: 68 - 340 Nm. Length: 405 mm. Angle Range 0-360°.

Accuracy: +/- 2%.
Resolution: 0.1Nm (0.1lb-ft).
Preset: 10.
Memory (Torque): 100 (10 per angle).
Memory (Angle): 50.
Measurements Unit: (Nm. Lb-ft. In-ft. Kg-m).
Mode: Trace / Peak.
Indicators: LED & Buzzer.
Battery 3pcs * AAA.
Auto shut off: 60seconds.
Operating ambient temperature: 10°C-60 °C
°F-139.9 °F).
Storage temperature: -20 °C -70 °C (-4 °F-57.9 °F).
Operating relative humidity: 15-90% non-condensing.

Art. 8058-WW



Torque Wrench 3/8"Dr 20-100NM Digital With Angle Settings

Torque Tools > 3/8" Torque Wrench

Professional workshop grade torque wrench suitable for daily use. Includes a built in LCD read out with LED, sound and vibration alarms to indicate correct torque levels. Designed with an angle mode making angle gauges redundant saving time and producing accurate results. Cumulative angle measurements for use when space is limited. Space for up to 5 user presets. Reversible with 72tooth ratchet. Supplied with test certificate. Torque: 20 - 100 Nm. Length: 405 mm. Angle Range: 0 - 360°. Accuracy: +/- 2%.

Resolution: 0.1Nm (0.1lb-ft).
Preset: 10.
Memory (Torque): 100 (10 per angle).
Memory (Angle): 50.
Measurements Unit: (Nm. Lb-ft. In-ft. Kg-m).
Mode: Trace / Peak.
Indicators: LED & Buzzer.
Battery 3pcs * AAA.
Auto shut off: 60seconds.
Operating ambient temperature: 10°C-60 °C
°F-139.9 °F).
Storage temperature: -20 °C -70 °C (-4 °F-57.9 °F).
Operating relative humidity: 15-90% non-condensing.

Art. 8059-WW



Torque Wrench 3/8"Dr 27-135NM Digital With Angle Settings

Torque Tools > 3/8" Torque Wrench

Professional workshop grade torque wrench suitable for daily use. Includes a built in LCD read out with LED, sound and vibration alarms to indicate correct torque levels. Designed with an angle mode making angle gauges redundant saving time and producing accurate results. Cumulative angle measurements for use when space is limited. Space for up-to 5 user presets. Reversible with 72tooth ratchet. Supplied with test certificate. Torque: 27 - 135 Nm. Length: 405 mm. Angle Range 0-360°. Accuracy: +/- 2%.

Resolution: 0.1Nm (0.1lb-ft).
Preset: 10.
Memory (Torque): 100 (10 per angle).
Memory (Angle): 50.
Measurements Unit: (Nm. Lb-ft. In-ft. Kg-m).
Mode: Trace / Peak.
Indicators: LED & Buzzer.
Battery 3pcs * AAA.
Auto shut off: 60seconds.
Operating ambient temperature: 10°C-60 °C
°F-139.9 °F).
Storage temperature: -20 °C -70 °C (-4 °F-57.9 °F).
Operating relative humidity: 15-90% non-condensing.

Art. 8060-WW



Crowfoot Spanner Set; 1/2', 20-32mm

Crowfoot Wrenches > Crowfoot Wrench Set

Sizes Included: 20, 21, 22, 23, 24, 25, 26, 27, 28, 30, 32mm.
Universal joint handle: 385 mm.
Extension bar: 125 mm.
1/2" drive.



Art. 4029-WW

Crowfoot Spanner Set; 1/2", 10-19 mm

Crowfoot Wrenches > Crowfoot Wrench Set

Sizes: 10, 11, 12, 13, 14, 15, 16, 17, 18, 19 mm.
3/8" drive.



Art. 4216-WW

Ratchet Combination Wrench

Fine 72 tooth ratchet.
Sizes: 8, 10, 12, 13, 14, 17, 19 mm.
12-point ratchet head.



Art. 1090-WW

Ratchet Combination Wrench

Fine 72 tooth ratchet.
Sizes: 8, 10, 12, 13, 14, 15, 17, 19 mm.
12-point ratchet head.
Flexi-Head.



Art. 1091-WW

Universal Extender Wrench Tool

Spanner Accessories > Spanner Accessories

Extend the length of standard wrenches to improve reach and torque.
Made from Chrome Vanadium with high chrome finish.
Length: 385mm.
Universal use.



Art. 7451-WW

XL Version: Art. 7450-WW

Ratchet Spanner Set; E-Torx Profile

Spanner Sets > Specialist Spanner Sets

Sizes: 6+8, 10+12, 14+18, 20+24 mm.
Flexi-head on both ends.



Art. 1001-WW

Line Spanners; Offset

Spanner Sets > Specialist Spanner Sets

Huge time saver as when working on various pipes they can be located in awkward areas.
Specially designed for use on hard to reach screw connections found on brake lines, fuel lines, oil pipes and radiator lines.
Sizes: 8, 9, 10, 11, 12mm.



Art. 1004-WW

Spanners for Poly-V-Belts

Spanner Sets > Specialist Spanner Sets

45 degree offset ends to reach awkward areas in the engine bay.
Sizes: 13, 15, 16, 17, 19 mm (460 mm long).
For use on the idler belt.
12 pt profiles.



Art. 1060-WW

Fuel Tank Sender Unit Spanner Set

Spanner Sets > Specialist Spanner Sets

For assembly and disassembly of the plastic retaining rings of the fuel tank sender unit.
5 different shaped pairs of clamping arms allow use on a variety of fuel tanks.
Can be used for diameters of 75-160mm, 80-122mm and 110-170mm.
Can be used with 2 and 3 arms.
24 mm hexagon drive.

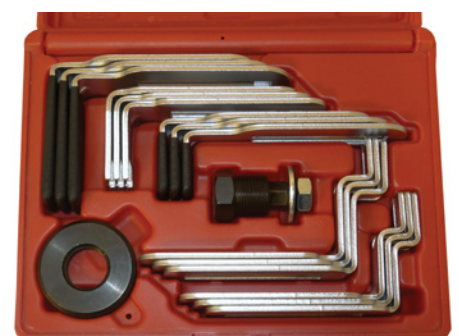

Art. 1065-WW

E-Profile Poly-V-Belt Spanners

Spanner Sets > Specialist Spanner Sets

The special design allows for access to awkward areas within the engine bay. Designed for the removal of screws on the belt and tensioning pulley. Sizes: E10, 12, 14, 16, 18 (460 mm long).



Art. 1100-WW

Ratchet Brake Pipe Spanners

Spanner Sets > Specialist Spanner Sets

Brake lines, fuel lines etc. can be awkward and hard to reach. This set allows fast and easy access. Sizes: 8, 9, 10, 11, 12 mm. Fine 72 tooth ratchet.



Art. 1188-WW

Spanner Set; Aviation Type, Double Ring, 8-24 mm (Master Set)

Spanner Sets > Double Ring Spanner Sets

Sizes: 8x9mm, 10x12mm, 11x13mm, 14x15mm, 16x17mm, 18x19mm, 21x23mm, 22x24mm. Aviation double ring type.



Art. 809-WW



SINGLE RATCHETS

Available seperately, in single ratchets section.

Spanner Set; Aviation Type with Multi-spline Profile

Spanner Sets > Double Ring Spanner Sets

Sizes: 8x9, 10x11, 12x13, 14x15, 16x17, 18x19. The special multi-lock profile allows these spanners to be used on: square, hex, 30% rounded, torx, bi-hex and spline profile. The longer length allows more leverage.



Art. 1021-WW

Combination Spanner Set; Jumbo, 34-50 mm

Spanner Sets > Combination Spanner Sets

Sizes: 34mm, 36mm, 38mm, 41mm, 46mm, 50mm.
Polished jaws & rings.
Carbon steel.



Art. 800027-UTC

Spanner Set; Aviation Type, Double Ring, 8-24 mm

Spanner Sets > Double Ring Spanner Sets

Sizes: 8x10mm, 11x13mm, 14x15mm, 16x17mm, 18x19mm, 22x24mm.
The longer length allows for more leverage giving increased torque.
Straight type, 0 degree offset.



Art. 816-WW

Double Ring Spanners for E-Type Screws (external), E6xE8-E20xE24

Spanner Sets > Double Ring Spanner Sets

Sizes: E6xE8, E10xE12, E14xE18, E20xE24.
Full Chrome finish.
Straight and flat.



Art. 8012-WW

12-Piece Fast Action Wrenches 8-21 mm

Spanner Sets > Combination Spanner Sets

The longer length allows for more leverage giving increased torque.
Sizes: 8x10mm, 11x13mm, 14x15mm, 16x17mm, 18x19mm, 22x24mm.
Straight type, 0 degree offset.
Demonstration bar available: 1186-1-WW.



Art. 1186-WW

Combination Spanner Set; 8-19 mm

Spanner Sets > Combination Spanner Sets

8031-1-WW 8-mm Combination Spanner.
 8031-2-WW 9-mm Combination Spanner.
 8031-3-WW 10-mm Combination Spanner.
 8031-4-WW 11-mm Combination Spanner.
 8031-5-WW 12-mm Combination Spanner.
 8031-6-WW 13-mm Combination Spanner.
 8031-7-WW 14-mm Combination Spanner.
 8031-8-WW 15-mm Combination Spanner.
 8031-9-WW 16-mm Combination Spanner.
 8031-10-WW 17-mm Combination Spanner.
 8031-11-WW 18-mm Combination Spanner.
 8031-12-WW 19-mm Combination Spanner.
 Also available in foam tray: 2580-WW.



Wallet: **8031-WW** Foam Tray: **2580-WW**

 **SINGLE RATCHETS**
 Available separately, in single ratchets section.

Combination Spanner Set; 6-32 mm

Spanner Sets > Combination Spanner Sets

Sizes: 6,7,8,9,10,11,12,13,14,15,16,17,18,19, 20, 21,22, 23,24,25,26,27,28,30,32 mm.
 Manufactured in accordance with DIN 3113A.
 Polished Chrome finish.



Art. **8032-WW**

 **SINGLE RATCHETS**
 Available separately, in single ratchets section.

10-Piece Stubby Spanner Set 8-19 mm

Spanner Sets > Combination Spanner Sets

Sizes: 10mm, 11mm, 12mm,13mm, 14mm, 15mm, 16mm, 17mm, 18mm, 19mm.
 Profile: Stubby.



Art. **806-WW**

Ratchet Spanner Set; Ring & Ratchet, 8-19 mm

Spanner Sets > Ratchet Spanner Sets

8 mm, 9 mm, 10 mm, 11 mm, 12 mm, 13 mm, 14 mm, 15 mm, 16 mm, 17 mm, 18 mm, 19 mm.
 Double ring and fixed spanner.
 Sizes available separately, in single ratchets section.



Art. **60035-WW**

 **SINGLE RATCHETS**
 Available separately, in single ratchets section.

Wrenches

Ratchet Spanner Set; Double Flexi-Head, 8-19 mm

Spanner Sets > Ratchet Spanner Sets

The special design of the head allows 180 degree rotation in 2 directions, perfect for hard to reach areas.

Sizes: 8, 9, 10, 11, 12, 13, 14, 15, 16, 17, 18, 19 mm.

Made for awkward and hard to reach areas.



Art. 800023-UTC

Ratchet Spanner Set; 8-19 mm

Spanner Sets > Ratchet Spanner Sets

Includes the following sizes: 8-9-10-11-12-13-14-15-16-17-18-19 mm.

Spanners with 72 teeth, smallest adjustment angle 5°.

Also available in foam tray: 2581-WW.



Wallet: 8009-WW

Foam Tray: 2581-WW



SINGLE RATCHETS

Available separately, in single ratchets section.

Ratchet Spanner Set; with Flexi-Head, 8-19 mm

Spanner Sets > Ratchet Spanner Sets

Sizes: 8, 9, 12, 13, 14, 15, 16, 17, 18, 19 mm.

180 degree rotational head.

Fine 72 tooth ratchet.

Open ended.

Also available in foam tray: 2579-WW.



Wallet: 8010-WW

Foam Tray: 2579-WW



SINGLE RATCHETS

Available separately, in single ratchets section.

Ratchet Spanner Set; Fixed-Head, Stubby, 8-19 mm

Spanner Sets > Ratchet Spanner Sets

Includes the following sizes: 8mm, 9mm, 10mm, 11mm, 12mm, 13mm, 14mm, 15mm, 16mm, 17mm, 18mm, 19mm.

Length of each spanner: 8=89mm, 9=95mm, 10=97mm, 11=100mm, 12=102mm,

13=109mm, 14=115mm, 15=119mm, 16=123mm, 17=129mm, 18=132mm, 19=141mm.

180° rotating ratchet ring head.

72 fine tooth.



Art. 6017-WW



SINGLE RATCHETS

Available separately, in single ratchets section.

Ratchet Spanner Set; Flexi-Head, Stubby, 8-19 mm

Spanner Sets > Ratchet Spanner Sets

Includes the following sizes: 8mm, 9mm, 10mm, 11mm, 12mm, 13mm, 14mm, 15mm, 16mm, 17mm, 18mm, 19mm.
 Length of each spanner: 8=89mm, 9=95mm, 10=97mm, 11=100mm, 12=102mm, 13=109mm, 14=115mm, 15=119mm, 16=123mm, 17=129mm, 18=132mm, 19=141mm.
 180° rotating ratchet ring head.
 72 fine tooth.



SINGLE RATCHETS

Available separately, in single ratchets section.

Art. 8017-WW

Ratchet Spanner Set; XL, 8-32 mm

Spanner Sets > Ratchet Spanner Sets

Sizes: 8, 10, 12, 13, 14, 17, 19, 21, 22, 24, 27, 30, 32 mm.
 Manufactured in accordance with DIN 3113A.
 Polished Chrome finish.
 Fine 72 tooth ratchet.



SINGLE RATCHETS

Available separately, in single ratchets section.

Art. 807-WW

Ratchet Spanner Set; Reversible Switch, 8-24 mm

Spanner Sets > Ratchet Spanner Sets

Manufactured from high-quality, tempered & hardened chrome-vanadium steel.
 Sizes: 8, 9, 10, 11, 12, 13, 14, 15, 16, 17, 18, 19, 20, 21, 22, 24 mm.
 72 Teeth ratcheting box head.



SINGLE RATCHETS

Available separately, in single ratchets section.

Art. 808-WW

Ratchet Spanner Set; Aviation Type, Flexi-Head 8-19 mm

Spanner Sets > Ratchet Spanner Sets

The longer length allows for more leverage giving increased torque.
 Sizes:
 8x10, 10x11, 12x13, 14x15, 16x18, 17x19.
 180 degree flexible head.
 Length: 237 to 412 mm.
 Ratcheting function.



SINGLE RATCHETS

Available separately, in single ratchets section.

Art. 817-WW

SINGLE SOCKETRY

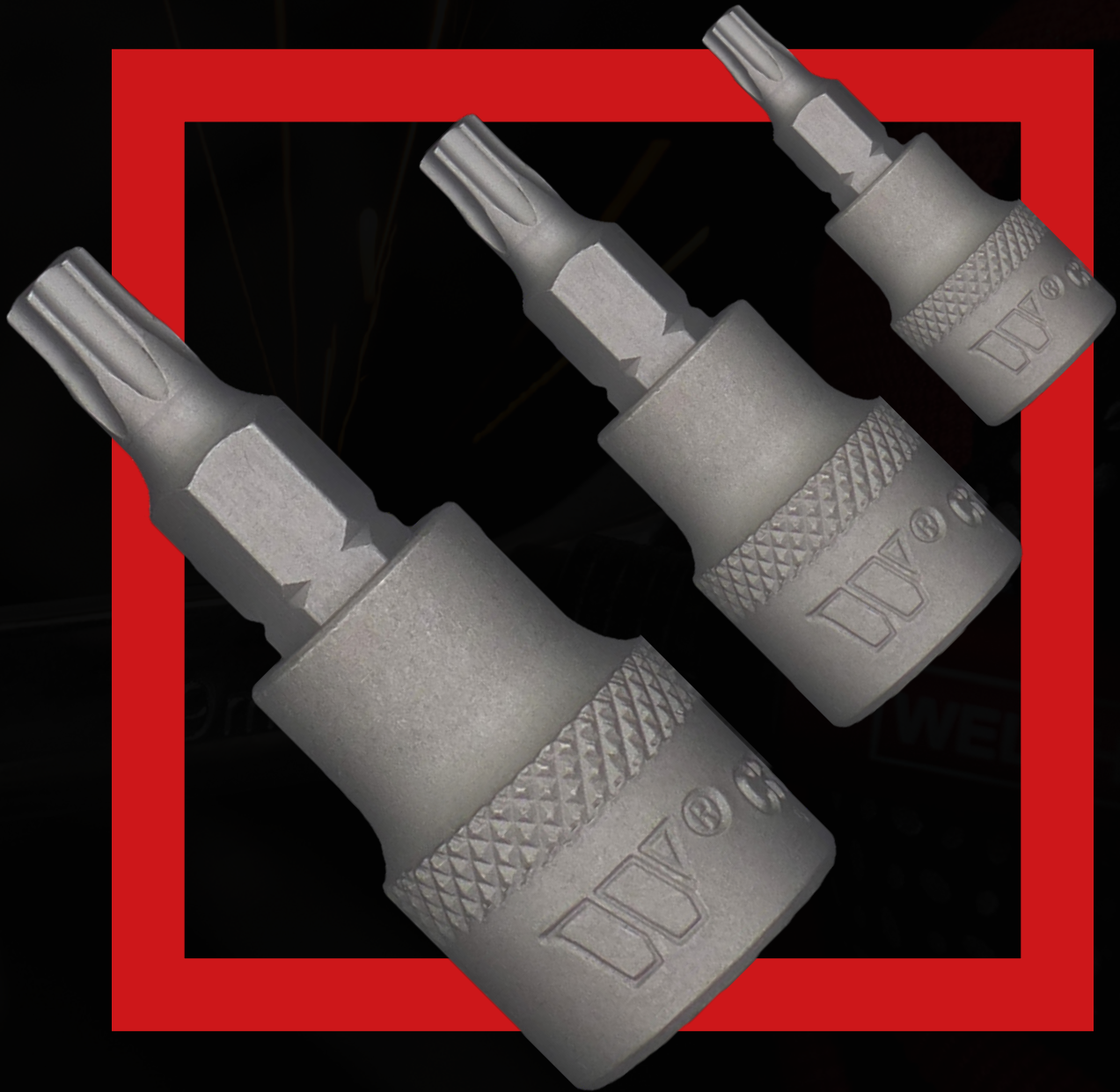

1/4" Bit Socket, T6, 37mm	Art. 1165-1-1-WW
3/8" Bit Socket, T45, 48mm	Art. 1165-1-10-WW
3/8" Bit Socket, T47, 48mm	Art. 1165-1-11-WW
3/8" Bit Socket, T50, 48mm	Art. 1165-1-12-WW
3/8" Bit Socket, T55, 48mm	Art. 1165-1-13-WW
1/2" Bit Socket, T60, 55mm	Art. 1165-1-14-WW
1/2" Bit Socket, T70, 55mm	Art. 1165-1-15-WW
1/4" Bit Socket, T8, 37mm	Art. 1165-1-2-WW
1/4" Bit Socket, T10, 37mm	Art. 1165-1-3-WW
1/4" Bit Socket, T15, 37mm	Art. 1165-1-4-WW
1/4" Bit Socket, T20, 37mm	Art. 1165-1-5-WW
1/4" Bit Socket, T25, 37mm	Art. 1165-1-6-WW
1/4" Bit Socket, T27, 37mm	Art. 1165-1-7-WW
1/4" Bit Socket, T30, 37mm	Art. 1165-1-8-WW
3/8" Bit Socket, T40, 48mm	Art. 1165-1-9-WW
1/4" Bit Socket, 8IP, 37mm	Art. 1165-2-1-WW
3/8" Bit Socket, 50IP, 48mm	Art. 1165-2-10-WW
3/8" Bit Socket, 55IP, 48mm	Art. 1165-2-11-WW
1/2" Bit Socket, 60IP, 55mm	Art. 1165-2-12-WW
1/4" Bit Socket, 10IP, 37mm	Art. 1165-2-2-WW
1/4" Bit Socket, 15IP, 37mm	Art. 1165-2-3-WW
1/4" Bit Socket, 20IP, 37mm	Art. 1165-2-4-WW
1/4" Bit Socket, 25IP, 37mm	Art. 1165-2-5-WW
1/4" Bit Socket, 27IP, 37mm	Art. 1165-2-6-WW
1/4" Bit Socket, 30IP, 37mm	Art. 1165-2-7-WW
3/8" Bit Socket, 40IP, 48mm	Art. 1165-2-8-WW
3/8" Bit Socket, 45IP, 48mm	Art. 1165-2-9-WW
1/4" Bit Socket, T8H, 37mm	Art. 1165-3-1-WW
3/8" Bit Socket, T50H, 48mm	Art. 1165-3-10-WW
3/8" Bit Socket, T55H, 48mm	Art. 1165-3-11-WW
1/2" Bit Socket, T60H, 55mm	Art. 1165-3-12-WW
1/4" Bit Socket, T10H, 37mm	Art. 1165-3-2-WW
1/4" Bit Socket, T15H, 37mm	Art. 1165-3-3-WW
1/4" Bit Socket, T20H, 37mm	Art. 1165-3-4-WW
1/4" Bit Socket, T25H, 37mm	Art. 1165-3-5-WW
1/4" Bit Socket, T27H, 37mm	Art. 1165-3-6-WW
1/4" Bit Socket, T30H, 37mm	Art. 1165-3-7-WW
3/8" Bit Socket, T40H, 48mm	Art. 1165-3-8-WW
3/8" Bit Socket, T45H, 48mm	Art. 1165-3-9-WW
Bit Socket; H10, 3/8"	Art. 4041-H10-WW
Bit Socket; H12, 3/8"	Art. 4041-H12-WW
Bit Socket; H14, 1/2"	Art. 4041-H14-WW
Bit Socket; H15, 1/2"	Art. 4041-H15-WW
Bit Socket; H17, 1/2"	Art. 4041-H17-WW
Bit Socket; H19, 1/2"	Art. 4041-H19-WW
Bit Socket; H2, 1/4"	Art. 4041-H2-WW
Bit Socket; H2.5, 1/4"	Art. 4041-H2.5-WW
Bit Socket; H22, 1/2"	Art. 4041-H22-WW
Bit Socket; H3, 1/4"	Art. 4041-H3-WW
Bit Socket; H4, 1/4"	Art. 4041-H4-WW
Bit Socket; H5, 1/4"	Art. 4041-H5-WW
Bit Socket; H5.5, 1/4"	Art. 4041-H5.5-WW
Bit Socket; H6, 1/4"	Art. 4041-H6-WW
Bit Socket; H7, 1/4"	Art. 4041-H7-WW
Bit Socket; H8, 1/4"	Art. 4041-H8-WW
Bit Socket; H9, 1/4"	Art. 4041-H9-WW
Bit Socket; M10, 3/8"	Art. 4054-M10-WW
Bit Socket; M12, 3/8"	Art. 4054-M12-WW
Bit Socket; M13, 1/2"	Art. 4054-M13-WW
Bit Socket; M14, 1/2"	Art. 4054-M14-WW
Bit Socket; M16, 1/2"	Art. 4054-M16-WW
Bit Socket; M18, 1/2"	Art. 4054-M18-WW



Single Socketry

Bit Socket; M4, 1/4"	Art. 4054-M4-WW
Bit Socket; M5, 1/4"	Art. 4054-M5-WW
Bit Socket; M6, 1/4"	Art. 4054-M6-WW
Bit Socket; M7, 1/4"	Art. 4054-M7-WW
Bit Socket; M8, 3/8"	Art. 4054-M8-WW
Bit Socket; M9, 3/8"	Art. 4054-M9-WW
Bit Socket; Torx, T30	Art. 4068-T30-WW
Bit Socket; Torx, T40	Art. 4068-T40-WW
Bit Socket; Torx, T45	Art. 4068-T45-WW
Bit Socket; Torx, T50	Art. 4068-T50-WW
Bit Socket; Torx, T55	Art. 4068-T55-WW
Bit Socket; Torx, T60	Art. 4068-T60-WW
Bit Socket; Torx, T70	Art. 4068-T70-WW
Bit Socket; Torx, T80	Art. 4068-T80-WW
Bit Socket; Impact, M10	Art. 4070-M10-WW
Bit Socket; Impact, M12	Art. 4070-M12-WW
Bit Socket; Impact, M14	Art. 4070-M14-WW
Bit Socket; Impact, M16	Art. 4070-M16-WW
Bit Socket; Impact, M18	Art. 4070-M18-WW
Bit Socket; Impact, M5	Art. 4070-M5-WW
Bit Socket; Impact, M6	Art. 4070-M6-WW
Bit Socket; Impact, M8	Art. 4070-M8-WW
Bit Socket; Impact, 6pt, H10	Art. 4071-H10-WW
Bit Socket; Impact, 6pt, H12	Art. 4071-H12-WW
Bit Socket; Impact, 6pt, H14	Art. 4071-H14-WW
Bit Socket; Impact, 6pt, H17	Art. 4071-H17-WW
Bit Socket; Impact, 6pt, H19	Art. 4071-H19-WW
Bit Socket; Impact, 6pt, H5	Art. 4071-H5-WW
Bit Socket; Impact, 6pt, H6	Art. 4071-H6-WW
Bit Socket; Impact, 6pt, H8	Art. 4071-H8-WW
Bit Socket; Impact, 6pt, H19	Art. 4107-H19-WW
Bit Socket; Low Profile, Impact, M10	Art. 4167-M10-WW
Bit Socket; Low Profile, Impact, M12	Art. 4167-M12-WW
Bit Socket; Low Profile, Impact, M14	Art. 4167-M14-WW
Bit Socket; Low Profile, Impact, M16	Art. 4167-M16-WW
Bit Socket; Low Profile, Impact, M18	Art. 4167-M18-WW
Bit Socket; Low Profile, Impact, M4	Art. 4167-M4-WW
Bit Socket; Low Profile, Impact, M5	Art. 4167-M5-WW
Bit Socket; Low Profile, Impact, M6	Art. 4167-M6-WW
Bit Socket; Low Profile, Impact, M8	Art. 4167-M8-WW
Bit Socket; Low Profile, Impact, T10	Art. 4168-T10-WW
Bit Socket; Low Profile, Impact, T15	Art. 4168-T15-WW
Bit Socket; Low Profile, Impact, T20	Art. 4168-T20-WW
Bit Socket; Low Profile, Impact, T25	Art. 4168-T25-WW
Bit Socket; Low Profile, Impact, T27	Art. 4168-T27-WW
Bit Socket; Low Profile, Impact, T30	Art. 4168-T30-WW
Bit Socket; Low Profile, Impact, T40	Art. 4168-T40-WW
Bit Socket; Low Profile, Impact, T45	Art. 4168-T45-WW
Bit Socket; Low Profile, Impact, T47	Art. 4168-T47-WW
Bit Socket; Low Profile, Impact, T50	Art. 4168-T50-WW
Bit Socket M10 200MM Length; 1/2dr Spline	Art. 5180-10-200-WW
Bit Socket M10 100MM Length; 1/2dr Spline	Art. 5180-M10-100-WW
Bit Socket M10 140MM Length; 1/2dr Spline	Art. 5180-M10-140-WW
Bit Socket M10 55MM Length; 1/2dr Spline	Art. 5180-M10-55-WW
Bit Socket M12 100MM Length; 1/2dr Spline	Art. 5180-M12-100-WW
Bit Socket M12 140MM Length; 1/2dr Spline	Art. 5180-M12-140-WW
Bit Socket M12 200MM Length; 1/2dr Spline	Art. 5180-M12-200-WW
Bit Socket M12 55MM Length; 1/2dr Spline	Art. 5180-M12-55-WW
Bit Socket M14 100MM Length; 1/2dr Spline	Art. 5180-M14-100-WW
Bit Socket M14 140MM Length; 1/2dr Spline	Art. 5180-M14-140-WW
Bit Socket M14 200MM Length; 1/2dr Spline	Art. 5180-M14-200-WW
Bit Socket M14 55MM Length; 1/2dr Spline	Art. 5180-M14-55-WW
Bit Socket M16 55MM Length; 1/2dr Spline	Art. 5180-M16-55-WW
Bit Socket M5 100MM Length; 1/2dr Spline	Art. 5180-M5-100-WW
Bit Socket M5 140MM Length; 1/2dr Spline	Art. 5180-M5-140-WW



Bit Socket M5 55MM Length; 1/2dr Spline	Art. 5180-M5-55-WW
Bit Socket M6 100MM Length; 1/2dr Spline	Art. 5180-M6-100-WW
Bit Socket M6 140MM Length; 1/2dr Spline	Art. 5180-M6-140-WW
Bit Socket M6 55MM Length; 1/2dr Spline	Art. 5180-M6-55-WW
Bit Socket M8 100MM Length; 1/2dr Spline	Art. 5180-M8-100-WW
Bit Socket M8 140MM Length; 1/2dr Spline	Art. 5180-M8-140-WW
Bit Socket M8 200MM Length; 1/2dr Spline	Art. 5180-M8-200-WW
Bit Socket M8 55MM Length; 1/2dr Spline	Art. 5180-M8-55-WW
Bit Socket M9 100MM Length; 1/2dr Spline	Art. 5180-M9-100-WW
Bit Socket M9 140MM Length; 1/2dr Spline	Art. 5180-M9-140-WW
Bit Socket M9 55MM Length; 1/2dr Spline	Art. 5180-M9-55-WW
Bit Socket T20 100mm Length; 1/2dr T-Star	Art. 5182-T20-100-WW
Bit Socket T20 55mm Length; 1/2dr T-Star	Art. 5182-T20-55-WW
Bit Socket T25 100mm Length; 1/2dr T-Star	Art. 5182-T25-100-WW
Bit Socket T25 55mm Length; 1/2dr T-Star	Art. 5182-T25-55-WW
Bit Socket T27 100mm Length; 1/2dr T-Star	Art. 5182-T27-100-WW
Bit Socket T27 55mm Length; 1/2dr T-Star	Art. 5182-T27-55-WW
Bit Socket T30 100mm Length; 1/2dr T-Star	Art. 5182-T30-100-WW
Bit Socket T30 55mm Length; 1/2dr T-Star	Art. 5182-T30-55-WW
Bit Socket T40 100mm Length; 1/2dr T-Star	Art. 5182-T40-100-WW
Bit Socket T40 140mm Length; 1/2dr T-Star	Art. 5182-T40-140-WW
Bit Socket T40 200mm Length; 1/2dr T-Star	Art. 5182-T40-200-WW
Bit Socket T40 55mm Length; 1/2dr T-Star	Art. 5182-T40-55-WW
Bit Socket T45 100mm Length; 1/2dr T-Star	Art. 5182-T45-100-WW
Bit Socket T45 140mm Length; 1/2dr T-Star	Art. 5182-T45-140-WW
Bit Socket T45 200mm Length; 1/2dr T-Star	Art. 5182-T45-200-WW
Bit Socket T45 55mm Length; 1/2dr T-Star	Art. 5182-T45-55-WW
Bit Socket T50 100mm Length; 1/2dr T-Star	Art. 5182-T50-100-WW
Bit Socket T50 140mm Length; 1/2dr T-Star	Art. 5182-T50-140-WW
Bit Socket T50 200mm Length; 1/2dr T-Star	Art. 5182-T50-200-WW
Bit Socket T50 55mm Length; 1/2dr T-Star	Art. 5182-T50-55-WW
Bit Socket T55 100mm Length; 1/2dr T-Star	Art. 5182-T55-100-WW
Bit Socket T55 140mm Length; 1/2dr T-Star	Art. 5182-T55-140-WW
Bit Socket T55 200mm Length; 1/2dr T-Star	Art. 5182-T55-200-WW
Bit Socket T55 55mm Length; 1/2dr T-Star	Art. 5182-T55-55-WW
Bit Socket T60 100mm Length; 1/2dr T-Star	Art. 5182-T60-100-WW
Bit Socket T60 140mm Length; 1/2dr T-Star	Art. 5182-T60-140-WW
Bit Socket T60 200mm Length; 1/2dr T-Star	Art. 5182-T60-200-WW
Bit Socket T60 55mm Length; 1/2dr T-Star	Art. 5182-T60-55-WW
Bit Socket T70 100mm Length; 1/2dr T-Star	Art. 5182-T70-100-WW
Bit Socket T70 140mm Length; 1/2dr T-Star	Art. 5182-T70-140-WW
Bit Socket T70 200mm Length; 1/2dr T-Star	Art. 5182-T70-200-WW
Bit Socket T70 55mm Length; 1/2dr T-Star	Art. 5182-T70-55-WW
Bit Socket; 3/8dr Extra Long Allan Key 110mm H10	Art. 7023-H10-WW
Bit Socket; 3/8dr Extra Long Allan Key 110mm H3	Art. 7023-H3-WW
Bit Socket; 3/8dr Extra Long Allan Key 110mm H4	Art. 7023-H4-WW
Bit Socket; 3/8dr Extra Long Allan Key 110mm H5	Art. 7023-H5-WW
Bit Socket; 3/8dr Extra Long Allan Key 110mm H6	Art. 7023-H6-WW
Bit Socket; 3/8dr Extra Long Allan Key 110mm H7	Art. 7023-H7-WW
Bit Socket; 3/8dr Extra Long Allan Key 110mm H8	Art. 7023-H8-WW
Bit Socket; 3/8dr Extra Long Allan Key 110mm H9	Art. 7023-H9-WW
Bit Socket; Spline, 110mm, 3/8", M10	Art. 7023-M10-WW
Bit Socket; Spline, 110mm, 3/8", M4	Art. 7023-M4-WW
Bit Socket; Spline, 110mm, 3/8", M5	Art. 7023-M5-WW
Bit Socket; Spline, 110mm, 3/8", M6	Art. 7023-M6-WW
Bit Socket; Spline, 110mm, 3/8", M7	Art. 7023-M7-WW
Bit Socket; Spline, 110mm, 3/8", M8	Art. 7023-M8-WW
Bit Socket; Spline, 110mm, 3/8", M9	Art. 7023-M9-WW
Bit Socket; 3/8dr Extra Long Torx 110mm T20	Art. 7023-T20-WW
Bit Socket; 3/8dr Extra Long Torx 110mm T25	Art. 7023-T25-WW
Bit Socket; 3/8dr Extra Long Torx 110mm T27	Art. 7023-T27-WW
Bit Socket; 3/8dr Extra Long Torx 110mm T30	Art. 7023-T30-WW
Bit Socket; 3/8dr Extra Long Torx 110mm T40	Art. 7023-T40-WW
Bit Socket; 3/8dr Extra Long Torx 110mm T45	Art. 7023-T45-WW



Single Socketry

Bit Socket; Torx®, 1/4", 110mm, T8	Art. 7030-T8-WW
Bit Socket; Torx®, 1/4", 110mm, T10	Art. 7030-T10-WW
Bit Socket; Torx®, 1/4", 110mm, T15	Art. 7030-T15-WW
Bit Socket; Torx®, 1/4", 110mm, T20	Art. 7030-T20-WW
Bit Socket; Torx®, 1/4", 110mm, T25	Art. 7030-T25-WW
Bit Socket; Torx®, 1/4", 110mm, T27	Art. 7030-T27-WW
Bit Socket; Torx®, 1/4", 110mm, T30	Art. 7030-T30-WW
Bit Socket; Torx®, 3/8", 110mm, T40	Art. 7030-T40-WW
Bit Socket; Torx®, 3/8", 110mm, T45	Art. 7030-T45-WW
Bit Socket; Torx®, 3/8", 110mm, T47	Art. 7030-T47-WW
Bit Socket; Torx®, 3/8", 110mm, T50	Art. 7030-T50-WW
Bit Socket; Torx®, 3/8", 110mm, T55	Art. 7030-T55-WW
Bit Socket; Torx®, 1/4", 110mm, T6	Art. 7030-T6-WW
Bit Socket; Torx®, 1/2", 110mm, T60	Art. 7030-T60-WW
Bit Socket; Torx®, 1/2", 110mm, T70	Art. 7030-T70-WW
Bit Socket; Hex, 3/8", 110mm, 10 mm	Art. 7031-H10-WW
Bit Socket; Hex, 3/8", 110mm, 12 mm	Art. 7031-H12-WW
Bit Socket; Hex, 1/2", 110mm, 14 mm	Art. 7031-H14-WW
Bit Socket; Hex, 1/2", 110mm, 15 mm	Art. 7031-H15-WW
Bit Socket; Hex, 1/2", 110mm, 17 mm	Art. 7031-H17-WW
Bit Socket; Hex, 1/2", 110mm, 19 mm	Art. 7031-H19-WW
Bit Socket; Hex, 1/4", 110mm, 2 mm	Art. 7031-H2-WW
Bit Socket; Hex, 1/4", 110mm, 2.5 mm	Art. 7031-H2.5-WW
Bit Socket; Hex, 1/2", 110mm, 22 mm	Art. 7031-H22-WW
Bit Socket; Hex, 1/4", 110mm, 3 mm	Art. 7031-H3-WW
Bit Socket; Hex, 1/4", 110mm, 4 mm	Art. 7031-H4-WW
Bit Socket; Hex, 1/4", 110mm, 5 mm	Art. 7031-H5-WW
Bit Socket; Hex, 1/4", 110mm, 5.5 mm	Art. 7031-H5.5-WW
Bit Socket; Hex, 1/4", 110mm, 6 mm	Art. 7031-H6-WW
Bit Socket; Hex, 3/8", 110mm, 7 mm	Art. 7031-H7-WW
Bit Socket; Hex, 3/8", 110mm, 8 mm	Art. 7031-H8-WW
Bit Socket; Hex, 3/8", 110mm, 9 mm	Art. 7031-H9-WW
Bit Socket; Spline, 110 mm, 3/8", M10	Art. 7032-M10-WW
Bit Socket; Spline, 110 mm, 1/2", M12	Art. 7032-M12-WW
Bit Socket; Spline, 110 mm, 1/2", M13	Art. 7032-M13-WW
Bit Socket; Spline, 110 mm, 1/2", M14	Art. 7032-M14-WW
Bit Socket; Spline, 110 mm, 1/2", M16	Art. 7032-M16-WW
Bit Socket; Spline, 110 mm, 1/2", M18	Art. 7032-M18-WW
Bit Socket; Spline, 110 mm, 1/4", M4	Art. 7032-M4-WW
Bit Socket; Spline, 110 mm, 1/4", M5	Art. 7032-M5-WW
Bit Socket; Spline, 110 mm, 1/4", M6	Art. 7032-M6-WW
Bit Socket; Spline, 110 mm, 3/8", M7	Art. 7032-M7-WW
Bit Socket; Spline, 110 mm, 3/8", M8	Art. 7032-M8-WW
Bit Socket; Spline, 110 mm, 3/8", M9	Art. 7032-M9-WW
Bit Socket; 3/8dr Torx 48mm T20	Art. 7037-T20-WW
Bit Socket; 3/8dr Torx 48mm T25	Art. 7037-T25-WW
Bit Socket; 3/8dr Torx 48mm T27	Art. 7037-T27-WW
Bit Socket; 3/8dr Torx 48mm T30	Art. 7037-T30-WW
Bit Socket; 3/8dr Torx 48mm T40	Art. 7037-T40-WW
Bit Socket; 3/8dr Torx 48mm T45	Art. 7037-T45-WW
Bit Socket; Allan Key, 48 mm, 3/8", H10	Art. 7038-H10-WW
Bit Socket; Allan Key, 48 mm, 3/8", H3	Art. 7038-H3-WW
Bit Socket; Allan Key, 48 mm, 3/8", H4	Art. 7038-H4-WW
Bit Socket; Allan Key, 48 mm, 3/8", H5	Art. 7038-H5-WW
Bit Socket; Allan Key, 48 mm, 3/8", H6	Art. 7038-H6-WW
Bit Socket; Allan Key, 48 mm, 3/8", H7	Art. 7038-H7-WW
Bit Socket; Allan Key, 48 mm, 3/8", H8	Art. 7038-H8-WW
Bit Socket; Allan Key with Ball End, 48 mm, 3/8" H10	Art. 7039-H10-WW
Bit Socket; Allan Key with Ball End, 48 mm, 3/8", H3	Art. 7039-H3-WW
Bit Socket; Allan Key with Ball End, 48 mm, 3/8", H4	Art. 7039-H4-WW
Bit Socket; Allan Key with Ball End, 48 mm, 3/8", H5	Art. 7039-H5-WW
Bit Socket; Allan Key with Ball End, 48 mm, 3/8", H6	Art. 7039-H6-WW
Bit Socket; Allan Key with Ball End, 48 mm, 3/8", H7	Art. 7039-H7-WW
Bit Socket; Allan Key with Ball End, 48 mm, 3/8", H8	Art. 7039-H8-WW



1/2" Drive Lok-Typ Shallow Socket 8 mm	Art. 1063-1-WW
1/2" Drive Lok-Typ Shallow Socket 17 mm	Art. 1063-10-WW
1/2" Drive Lok-Typ Shallow Socket 18 mm	Art. 1063-11-WW
1/2" Drive Lok-Typ Shallow Socket 19 mm	Art. 1063-12-WW
1/2" Drive Lok-Typ Shallow Socket 20 mm	Art. 1063-13-WW
1/2" Drive Lok-Typ Shallow Socket 21 mm	Art. 1063-14-WW
1/2" Drive Lok-Typ Shallow Socket 22 mm	Art. 1063-15-WW
1/2" Drive Lok-Typ Shallow Socket 23 mm	Art. 1063-16-WW
1/2" Drive Lok-Typ Shallow Socket 24 mm	Art. 1063-17-WW
1/2" Drive Lok-Typ Shallow Socket 27 mm	Art. 1063-18-WW
1/2" Drive Lok-Typ Shallow Socket 30 mm	Art. 1063-19-WW
1/2" Drive Lok-Typ Shallow Socket 9 mm	Art. 1063-2-WW
1/2" Drive Lok-Typ Shallow Socket 32 mm	Art. 1063-20-WW
1/2" Drive Lok-Typ Shallow Socket 10 mm	Art. 1063-3-WW
1/2" Drive Lok-Typ Shallow Socket 11 mm	Art. 1063-4-WW
1/2" Drive Lok-Typ Shallow Socket 12 mm	Art. 1063-5-WW
1/2" Drive Lok-Typ Shallow Socket 13 mm	Art. 1063-6-WW
1/2" Drive Lok-Typ Shallow Socket 14 mm	Art. 1063-7-WW
1/2" Drive Lok-Typ Shallow Socket 15 mm	Art. 1063-8-WW
1/2" Drive Lok-Typ Shallow Socket 16 mm	Art. 1063-9-WW
Socket; 1/2", 10 mm	Art. 4141-10-WW
Socket; 1/2", 11 mm	Art. 4141-11-WW
Socket; 1/2", 12 mm	Art. 4141-12-WW
Socket; 1/2", 13 mm	Art. 4141-13-WW
Socket; 1/2", 14 mm	Art. 4141-14-WW
Socket; 1/2", 15 mm	Art. 4141-15-WW
Socket; 1/2", 16 mm	Art. 4141-16-WW
Socket; 1/2", 17 mm	Art. 4141-17-WW
Socket; 1/2", 18 mm	Art. 4141-18-WW
Socket; 1/2", 19 mm	Art. 4141-19-WW
Socket; 1/2", 20 mm	Art. 4141-20-WW
Socket; 1/2", 21 mm	Art. 4141-21-WW
Socket; 1/2", 22 mm	Art. 4141-22-WW
Socket; 1/2", 24 mm	Art. 4141-24-WW
Socket; 1/2", 27 mm	Art. 4141-27-WW
Socket; 1/2", 30 mm	Art. 4141-30-WW
Socket; 1/2", 32 mm	Art. 4141-32-WW
3/8" Drive Lok-Typ Socket 8 mm	Art. 1233-1-WW
3/8" Drive Lok-Typ Socket 17 mm	Art. 1233-10-WW
3/8" Drive Lok-Typ Socket 18 mm	Art. 1233-11-WW
3/8" Drive Lok-Typ Socket 19 mm	Art. 1233-12-WW
3/8" Drive Lok-Typ Socket 20 mm	Art. 1233-13-WW
3/8" Drive Lok-Typ Socket 21 mm	Art. 1233-14-WW
3/8" Drive Lok-Typ Socket 22 mm	Art. 1233-15-WW
3/8" Drive Lok-Typ Socket 9 mm	Art. 1233-2-WW
3/8" Drive Lok-Typ Socket 10 mm	Art. 1233-3-WW
3/8" Drive Lok-Typ Socket 11 mm	Art. 1233-4-WW
3/8" Drive Lok-Typ Socket 12 mm	Art. 1233-5-WW
3/8" Drive Lok-Typ Socket 13 mm	Art. 1233-6-WW
3/8" Drive Lok-Typ Socket 14 mm	Art. 1233-7-WW
3/8" Drive Lok-Typ Socket 15 mm	Art. 1233-8-WW
3/8" Drive Lok-Typ Socket 16 mm	Art. 1233-9-WW
3/8" Drive Lok-Typ Socket, Deep, 8 mm	Art. 1234-1-WW
3/8" Drive Lok-Typ Socket, Deep, 17 mm	Art. 1234-10-WW
3/8" Drive Lok-Typ Socket, Deep, 18 mm	Art. 1234-11-WW
3/8" Drive Lok-Typ Socket, Deep, 19 mm	Art. 1234-12-WW
3/8" Drive Lok-Typ Socket, Deep, 9 mm	Art. 1234-2-WW
3/8" Drive Lok-Typ Socket, Deep, 10 mm	Art. 1234-3-WW
3/8" Drive Lok-Typ Socket, Deep, 11 mm	Art. 1234-4-WW
3/8" Drive Lok-Typ Socket, Deep, 12 mm	Art. 1234-5-WW
3/8" Drive Lok-Typ Socket, Deep, 13 mm	Art. 1234-6-WW
3/8" Drive Lok-Typ Socket, Deep, 14 mm	Art. 1234-7-WW
3/8" Drive Lok-Typ Socket, Deep, 15 mm	Art. 1234-8-WW
3/8" Drive Lok-Typ Socket, Deep, 16 mm	Art. 1234-9-WW



Single Socketry

Socket; 3/8", 10 mm	Art. 4145-10-WW
Socket; 3/8", 11 mm	Art. 4145-11-WW
Socket; 3/8", 12 mm	Art. 4145-12-WW
Socket; 3/8", 13 mm	Art. 4145-13-WW
Socket; 3/8", 14 mm	Art. 4145-14-WW
Socket; 3/8", 15 mm	Art. 4145-15-WW
Socket; 3/8", 16 mm	Art. 4145-16-WW
Socket; 3/8", 17 mm	Art. 4145-17-WW
Socket; 3/8", 18 mm	Art. 4145-18-WW
Socket; 3/8", 19 mm	Art. 4145-19-WW
Socket; 3/8", 20 mm	Art. 4145-20-WW
Socket; 3/8", 21 mm	Art. 4145-21-WW
Socket; 3/8", 22 mm	Art. 4145-22-WW
Socket; 3/8", 23 mm	Art. 4145-23-WW
Socket; 3/8", 24 mm	Art. 4145-24-WW
Socket; 3/8", 8 mm	Art. 4145-8-WW
Socket; 3/8", 9 mm	Art. 4145-9-WW
Socket; Deep, 3/8", 8 mm	Art. 4146-8-WW
Socket; Deep, 3/8", 9 mm	Art. 4146-9-WW
Socket; Deep, 3/8", 10 mm	Art. 4146-10-WW
Socket; Deep, 3/8", 11 mm	Art. 4146-11-WW
Socket; Deep, 3/8", 12 mm	Art. 4146-12-WW
Socket; Deep, 3/8", 13 mm	Art. 4146-13-WW
Socket; Deep, 3/8", 14 mm	Art. 4146-14-WW
Socket; Deep, 3/8", 15 mm	Art. 4146-15-WW
Socket; Deep, 3/8", 16 mm	Art. 4146-16-WW
Socket; Deep, 3/8", 17 mm	Art. 4146-17-WW
Socket; Deep, 3/8", 18 mm	Art. 4146-18-WW
Socket; Deep, 3/8", 19 mm	Art. 4146-19-WW
Socket; Deep, 3/8", 20 mm	Art. 4146-20-WW
Socket; Deep, 3/8", 21 mm	Art. 4146-21-WW
4-MM 1/4 dr Lok-Typ Sockets Deep	Art. 4035-4-WW
5-MM 1/4 dr Lok-Typ Sockets Deep	Art. 4035-5-WW
5.5-MM 1/4 dr Lok-Typ Sockets Deep	Art. 4035-5.5-WW
6-MM 1/4 dr Lok-Typ Sockets Deep	Art. 4035-6-WW
7-MM 1/4 dr Lok-Typ Sockets Deep	Art. 4035-7-WW
8-MM 1/4 dr Lok-Typ Sockets Deep	Art. 4035-8-WW
9-MM 1/4 dr Lok-Typ Sockets Deep	Art. 4035-9-WW
10-MM 1/4 dr Lok-Typ Sockets Deep	Art. 4035-10-WW
11-MM 1/4 dr Lok-Typ Sockets Deep	Art. 4035-11-WW
12-MM 1/4 dr Lok-Typ Sockets Deep	Art. 4035-12-WW
4-MM 1/4 dr Lok-Typ Socket	Art. 4036-4-WW
5-MM 1/4 dr Lok-Typ Socket	Art. 4036-5-WW
5.5-MM 1/4 dr Lok-Typ Socket	Art. 4036-5.5-WW
6-MM 1/4 dr Lok-Typ Socket	Art. 4036-6-WW
7-MM 1/4 dr Lok-Typ Socket	Art. 4036-7-WW
8-MM 1/4 dr Lok-Typ Socket	Art. 4036-8-WW
9-MM 1/4 dr Lok-Typ Socket	Art. 4036-9-WW
10-MM 1/4 dr Lok-Typ Socket	Art. 4036-10-WW
11-MM 1/4 dr Lok-Typ Socket	Art. 4036-11-WW
12-MM 1/4 dr Lok-Typ Socket	Art. 4036-12-WW
13-MM 1/4 dr Lok-Typ Socket	Art. 4036-13-WW
1/4" dr Shallow Socket 4-mm	Art. 4143-4-WW
1/4" dr Shallow Socket 4.5-mm	Art. 4143-4.5-WW
1/4" dr Shallow Socket 5-mm	Art. 4143-5-WW
1/4" dr Shallow Socket 5.5-mm	Art. 4143-5.5-WW
1/4" dr Shallow Socket 6-mm	Art. 4143-6-WW
1/4" dr Shallow Socket 7-mm	Art. 4143-7-WW
1/4" dr Shallow Socket 8-mm	Art. 4143-8-WW
1/4" dr Shallow Socket 9-mm	Art. 4143-9-WW
1/4" dr Shallow Socket 10-mm	Art. 4143-10-WW
1/4" dr Shallow Socket 11-mm	Art. 4143-11-WW
1/4" dr Shallow Socket 12-mm	Art. 4143-12-WW
1/4" dr Shallow Socket 13-mm	Art. 4143-13-WW
1/4" dr Shallow Socket 14-mm	Art. 4143-14-WW



1/4"dr Deep Socket 4-mm	Art. 4144-4-WW
1/4"dr Deep Socket 4.5-mm	Art. 4144-4.5-WW
1/4"dr Deep Socket 5-mm	Art. 4144-5-WW
1/4"dr Deep Socket 5.5-mm	Art. 4144-5.5-WW
1/4"dr Deep Socket 6-mm	Art. 4144-6-WW
1/4"dr Deep Socket 7-mm	Art. 4144-7-WW
1/4"dr Deep Socket 8-mm	Art. 4144-8-WW
1/4"dr Deep Socket 9-mm	Art. 4144-9-WW
1/4"dr Deep Socket 10-mm	Art. 4144-10-WW
1/4"dr Deep Socket 11-mm	Art. 4144-11-WW
1/4"dr Deep Socket 12-mm	Art. 4144-12-WW
1/4"dr Deep Socket 13-mm	Art. 4144-13-WW
1/4"dr Deep Socket 14-mm	Art. 4144-14-WW
Protective Impact 1/2" with Plastic Coating; 17 mm	Art. 1080-17-WW
Protective Impact 1/2" with Plastic Coating; 19 mm	Art. 1080-19-WW
Protective Impact 1/2" with Plastic Coating; 21 mm	Art. 1080-21-WW
Socket; 1/2", 10 mm, Deep, Impact (Lok-Typ™)	Art. 1095-1-WW
Socket; 1/2", 11 mm, Deep, Impact (Lok-Typ™)	Art. 1095-2-WW
Socket; 1/2", 12 mm, Deep, Impact (Lok-Typ™)	Art. 1095-3-WW
Socket; 1/2", 13 mm, Deep, Impact (Lok-Typ™)	Art. 1095-4-WW
Socket; 1/2", 14 mm, Deep, Impact (Lok-Typ™)	Art. 1095-5-WW
Socket; 1/2", 15 mm, Deep, Impact (Lok-Typ™)	Art. 1095-6-WW
Socket; 1/2", 16 mm, Deep, Impact (Lok-Typ™)	Art. 1095-7-WW
Socket; 1/2", 17 mm, Deep, Impact (Lok-Typ™)	Art. 1095-8-WW
Socket; 1/2", 18 mm, Deep, Impact (Lok-Typ™)	Art. 1095-9-WW
Socket; 1/2", 19 mm, Deep, Impact (Lok-Typ™)	Art. 1095-10-WW
Socket; 1/2", 21 mm, Deep, Impact (Lok-Typ™)	Art. 1095-11-WW
Socket; 1/2", 22 mm, Deep, Impact (Lok-Typ™)	Art. 1095-12-WW
Socket; 1/2", 24 mm, Deep, Impact (Lok-Typ™)	Art. 1095-13-WW
Socket; 1/2", 27 mm, Deep, Impact (Lok-Typ™)	Art. 1095-14-WW
Socket; 1/2", 30 mm, Deep, Impact (Lok-Typ™)	Art. 1095-15-WW
Socket; 1/2", 32 mm, Deep, Impact (Lok-Typ™)	Art. 1095-16-WW
1/2" Female Socket, E18, 38mm	Art. 1165-4-10-WW
1/2" Female Socket, E20, 38mm	Art. 1165-4-11-WW
1/2" Female Socket, E22, 38mm	Art. 1165-4-12-WW
1/2" Female Socket, E24, 38mm	Art. 1165-4-13-WW
Socket; Impact, 6pt, Deep, 17 mm, 1/2"	Art. 4119-17-WW
Socket; Impact, 6pt, Deep, 19 mm, 1/2"	Art. 4119-19-WW
Socket; Impact, 6pt, Deep, 21 mm, 1/2"	Art. 4119-21-WW
Socket; Impact, 6pt, Deep, 24 mm, 1/2"	Art. 4119-24-WW
Socket; Impact, 6pt, Deep, 32 mm, 1/2"	Art. 4119-32-WW
Socket; 1/2 Deep Impact, 10 mm	Art. 4162-10-WW
Socket; 1/2 Deep Impact, 11 mm	Art. 4162-11-WW
Socket; 1/2 Deep Impact, 12 mm	Art. 4162-12-WW
Socket; 1/2 Deep Impact, 13 mm	Art. 4162-13-WW
Socket; 1/2 Deep Impact, 14 mm	Art. 4162-14-WW
Socket; 1/2 Deep Impact, 15 mm	Art. 4162-15-WW
Socket; 1/2 Deep Impact, 16 mm	Art. 4162-16-WW
Socket; 1/2 Deep Impact, 18 mm	Art. 4162-18-WW
Socket; 1/2 Deep Impact, 22 mm	Art. 4162-22-WW
Socket; 1/2 Deep Impact, 27 mm	Art. 4162-27-WW
Socket; 1/2 Deep Impact, 30 mm	Art. 4162-30-WW
Socket; Deep Impact, 1/2", 12pt, 10 mm	Art. 60070-10-WW
Socket; Deep Impact, 1/2", 12pt, 11 mm	Art. 60070-11-WW
Socket; Deep Impact, 1/2", 12pt, 12 mm	Art. 60070-12-WW
Socket; Deep Impact, 1/2", 12pt, 13 mm	Art. 60070-13-WW
Socket; Deep Impact, 1/2", 12pt, 14 mm	Art. 60070-14-WW
Socket; Deep Impact, 1/2", 12pt, 15 mm	Art. 60070-15-WW
Socket; Deep Impact, 1/2", 12pt, 16 mm	Art. 60070-16-WW
Socket; Deep Impact, 1/2", 12pt, 17 mm	Art. 60070-17-WW
Socket; Deep Impact, 1/2", 12pt, 18 mm	Art. 60070-18-WW
Socket; Deep Impact, 1/2", 12pt, 19 mm	Art. 60070-19-WW
Socket; Deep Impact, 1/2", 12pt, 21 mm	Art. 60070-21-WW
Socket; Deep Impact, 1/2", 12pt, 22 mm	Art. 60070-22-WW
Socket; Deep Impact, 1/2", 12pt, 24 mm	Art. 60070-24-WW



Single Socketry

Socket; Deep Impact, 1/2", 12pt, 27 mm	Art. 60070-27-WW
Socket; Deep Impact, 1/2", 12pt, 30 mm	Art. 60070-30-WW
Socket; Deep Impact, 1/2", 12pt, 33 mm	Art. 60070-33-WW
Socket; Deep Impact, 1/2", 12pt, 34 mm	Art. 60070-34-WW
Socket; Deep Impact, 1/2", 12pt, 36 mm	Art. 60070-36-WW
Socket; Deep Impact, 1/2", 12pt, 38 mm	Art. 60070-38-WW
Socket; Extra Deep, Impact, 1/2" 10mm	Art. 7001-10-WW
Socket; Extra Deep, Impact, 1/2" 12mm	Art. 7001-12-WW
Socket; Extra Deep, Impact, 1/2" 13mm	Art. 7001-13-WW
Socket; Extra Deep, Impact, 1/2" 14mm	Art. 7001-14-WW
Socket; Extra Deep, Impact, 1/2" 15mm	Art. 7001-15-WW
Socket; Extra Deep, Impact, 1/2" 17mm	Art. 7001-17-WW
Socket; Extra Deep, Impact, 1/2" 18mm	Art. 7001-18-WW
Socket; Extra Deep, Impact, 1/2" 19mm	Art. 7001-19-WW
Socket; Extra Deep, Impact, 1/2" 21mm	Art. 7001-21-WW
Socket; Extra Deep, Impact, 1/2" 22mm	Art. 7001-22-WW
Socket; Extra Deep, Impact, 1/2" 24mm	Art. 7001-24-WW
Socket; Extra Deep, Impact, 1/2" 27mm	Art. 7001-27-WW
Socket; Extra Deep, Impact, 1/2" 30mm	Art. 7001-30-WW
Socket; Extra Deep, Impact, 1/2" 32mm	Art. 7001-32-WW
Socket; Shallow, Impact 1/2", Lok-Typ, 10 mm	Art. 7024-10-WW
Socket; Shallow, Impact 1/2", Lok-Typ, 11 mm	Art. 7024-11-WW
Socket; Shallow, Impact 1/2", Lok-Typ, 12 mm	Art. 7024-12-WW
Socket; Shallow, Impact 1/2", Lok-Typ, 13 mm	Art. 7024-13-WW
Socket; Shallow, Impact 1/2", Lok-Typ, 14 mm	Art. 7024-14-WW
Socket; Shallow, Impact 1/2", Lok-Typ, 15 mm	Art. 7024-15-WW
Socket; Shallow, Impact 1/2", Lok-Typ, 16 mm	Art. 7024-16-WW
Socket; Shallow, Impact 1/2", Lok-Typ, 17 mm	Art. 7024-17-WW
Socket; Shallow, Impact 1/2", Lok-Typ, 18 mm	Art. 7024-18-WW
Socket; Shallow, Impact 1/2", Lok-Typ, 19 mm	Art. 7024-19-WW
Socket; Shallow, Impact 1/2", Lok-Typ, 21 mm	Art. 7024-21-WW
Socket; Shallow, Impact 1/2", Lok-Typ, 22 mm	Art. 7024-22-WW
Socket; Shallow, Impact 1/2", Lok-Typ, 24 mm	Art. 7024-24-WW
Socket; Shallow, Impact 1/2", Lok-Typ, 27 mm	Art. 7024-27-WW
Socket; Shallow, Impact 1/2", Lok-Typ, 30 mm	Art. 7024-30-WW
Socket; Shallow, Impact 1/2", Lok-Typ, 32 mm	Art. 7024-32-WW
Semi Deep Impact Socket, 1/2", 6pt, 10mm	Art. 7051-10-WW
Semi Deep Impact Socket, 1/2", 6pt, 11mm	Art. 7051-11-WW
Semi Deep Impact Socket, 1/2", 6pt, 12mm	Art. 7051-12-WW
Semi Deep Impact Socket, 1/2", 6pt, 13mm	Art. 7051-13-WW
Semi Deep Impact Socket, 1/2", 6pt, 14mm	Art. 7051-14-WW
Semi Deep Impact Socket, 1/2", 6pt, 15mm	Art. 7051-15-WW
Semi Deep Impact Socket, 1/2", 6pt, 16mm	Art. 7051-16-WW
Semi Deep Impact Socket, 1/2", 6pt, 17mm	Art. 7051-17-WW
Semi Deep Impact Socket, 1/2", 6pt, 18mm	Art. 7051-18-WW
Semi Deep Impact Socket, 1/2", 6pt, 19mm	Art. 7051-19-WW
Semi Deep Impact Socket, 1/2", 6pt, 21mm	Art. 7051-21-WW
Semi Deep Impact Socket, 1/2", 6pt, 22mm	Art. 7051-22-WW
Semi Deep Impact Socket, 1/2", 6pt, 23mm	Art. 7051-23-WW
Semi Deep Impact Socket, 1/2", 6pt, 24mm	Art. 7051-24-WW
Semi Deep Impact Socket, 1/2", 6pt, 27mm	Art. 7051-27-WW
Semi Deep Impact Socket, 1/2", 6pt, 30mm	Art. 7051-30-WW
Semi Deep Impact Socket, 1/2", 6pt, 32mm	Art. 7051-32-WW
Socket; 3/8", 8 mm, Deep, Impact (Lok-Typ™)	Art. 1094-1-WW
Socket; 3/8", 9 mm, Deep, Impact (Lok-Typ™)	Art. 1094-2-WW
Socket; 3/8", 16 mm, Deep, Impact (Lok-Typ™)	Art. 1094-10-WW
Socket; 3/8", 17 mm, Deep, Impact (Lok-Typ™)	Art. 1094-11-WW
Socket; 3/8", 18 mm, Deep, Impact (Lok-Typ™)	Art. 1094-12-WW
Socket; 3/8", 19 mm, Deep, Impact (Lok-Typ™)	Art. 1094-13-WW
Socket; 3/8", 10 mm, Deep, Impact (Lok-Typ™)	Art. 1094-3-WW
Socket; 3/8", 11 mm, Deep, Impact (Lok-Typ™)	Art. 1094-5-WW
Socket; 3/8", 12 mm, Deep, Impact (Lok-Typ™)	Art. 1094-6-WW
Socket; 3/8", 13 mm, Deep, Impact (Lok-Typ™)	Art. 1094-7-WW
Socket; 3/8", 14 mm, Deep, Impact (Lok-Typ™)	Art. 1094-8-WW
Socket; 3/8", 15 mm, Deep, Impact (Lok-Typ™)	Art. 1094-9-WW



3/8" Female Socket, E10, 28mm	Art. 1165-4-6-WW
3/8" Female Socket, E12, 28mm	Art. 1165-4-7-WW
3/8" Female Socket, E14, 28mm	Art. 1165-4-8-WW
3/8" Female Socket, E16, 28mm	Art. 1165-4-9-WW
1/4" Female Socket, E4, 25mm	Art. 1165-4-1-WW
1/4" Female Socket, E5, 25mm	Art. 1165-4-2-WW
1/4" Female Socket, E6, 25mm	Art. 1165-4-3-WW
1/4" Female Socket, E7, 25mm	Art. 1165-4-4-WW
1/4" Female Socket, E8, 25mm	Art. 1165-4-5-WW
Semi Deep Impact Socket, 3/8", 6pt, 8mm	Art. 7052-8-WW
Semi Deep Impact Socket, 3/8", 6pt, 9mm	Art. 7052-9-WW
Semi Deep Impact Socket, 3/8", 6pt, 10mm	Art. 7052-10-WW
Semi Deep Impact Socket, 3/8", 6pt, 11mm	Art. 7052-11-WW
Semi Deep Impact Socket, 3/8", 6pt, 12mm	Art. 7052-12-WW
Semi Deep Impact Socket, 3/8", 6pt, 13mm	Art. 7052-13-WW
Semi Deep Impact Socket, 3/8", 6pt, 14mm	Art. 7052-14-WW
Semi Deep Impact Socket, 3/8", 6pt, 15mm	Art. 7052-15-WW
Semi Deep Impact Socket, 3/8", 6pt, 16mm	Art. 7052-16-WW
Semi Deep Impact Socket, 3/8", 6pt, 17mm	Art. 7052-17-WW
Semi Deep Impact Socket, 3/8", 6pt, 18mm	Art. 7052-18-WW
Semi Deep Impact Socket, 3/8", 6pt, 19mm	Art. 7052-19-WW
Semi Deep Impact Socket, 3/8", 6pt, 21mm	Art. 7052-21-WW
Semi Deep Impact Socket, 3/8", 6pt, 22mm	Art. 7052-22-WW
Locking Wheel Nut Remover 26	Art. 2940-1-WW
Locking Wheel Nut Remover 35.8	Art. 2940-10-WW
Locking Wheel Nut Remover 36.8	Art. 2940-11-WW
Locking Wheel Nut Remover 27	Art. 2940-2-WW
Locking Wheel Nut Remover 28	Art. 2940-3-WW
Locking Wheel Nut Remover 28.8	Art. 2940-4-WW
Locking Wheel Nut Remover 28.9	Art. 2940-5-WW
Locking Wheel Nut Remover 30	Art. 2940-6-WW
Locking Wheel Nut Remover 30.9	Art. 2940-7-WW
Locking Wheel Nut Remover 31.8	Art. 2940-8-WW
Locking Wheel Nut Remover 34.8	Art. 2940-9-WW
Twist Socket; 3/8", 10 mm	Art. 4090-10-WW
Twist Socket; 3/8", 11 mm	Art. 4090-11-WW
Twist Socket; 3/8", 12 mm	Art. 4090-12-WW
Twist Socket; 3/8", 13 mm	Art. 4090-13-WW
Twist Socket; 3/8", 14 mm	Art. 4090-14-WW
Twist Socket; 3/8", 15 mm	Art. 4090-15-WW
Twist Socket; 3/8", 16 mm (5/8")	Art. 4090-16-WW
Twist Socket; 3/8", 17 mm	Art. 4090-17-WW
Twist Socket; 3/8", 19 mm (3/4")	Art. 4090-19-WW
Twist Socket; Long, 17 mm, 1/2"	Art. 60065-17-WW
Twist Socket; Long, 19 mm, 1/2"	Art. 60065-19-WW
Twist Socket; Long, 21 mm, 1/2"	Art. 60065-21-WW
Twist Socket; Long, 22 mm, 1/2"	Art. 60065-22-WW
3-mm Lok-Typ Torx Remover	Art. 7453-3-WW
4-mm Lok-Typ Torx Remover	Art. 7453-4-WW
5-mm Lok-Typ Torx Remover	Art. 7453-5-WW
6-mm Lok-Typ Torx Remover	Art. 7453-6-WW
7-mm Lok-Typ Torx Remover	Art. 7453-7-WW
8-mm Lok-Typ Torx Remover	Art. 7453-8-WW
10-mm Lok-Typ Torx Remover	Art. 7453-10-WW
12-mm Lok-Typ Torx Remover	Art. 7453-12-WW
Locking Wheel Nut Removal Adapter; 27.0	Art. 1158-2-WW
Locking Wheel Nut Removal Adapter; 28.0	Art. 1158-3-WW
Locking Wheel Nut Removal Adapter; 28.8	Art. 1158-4-WW
Locking Wheel Nut Removal Adapter; 28.9	Art. 1158-5-WW
Locking Wheel Nut Removal Adapter; 30.0	Art. 1158-6-WW
Locking Wheel Nut Removal Adapter; 30.9	Art. 1158-7-WW
Locking Wheel Nut Removal Adapter; 31.8	Art. 1158-8-WW



Single Socketry

34.8mm Socket lug Nut Socket	Art. 1158-12-WW
35.8mm Socket lug Nut Socket	Art. 1158-13-WW
36.8mm Socket lug Nut Socket	Art. 1158-14-WW
37.8mm Socket lug Nut Socket	Art. 1158-15-WW
38.8mm Socket lug Nut Socket	Art. 1158-16-WW
39.8mm Socket lug Nut Socket	Art. 1158-17-WW
Ratchet Spanner; Flexi-Head, Stubby, 10 mm	Art. 8017-3-WW
Ratchet Spanner; Flexi-Head, Stubby, 11 mm	Art. 8017-4-WW
Ratchet Spanner; Flexi-Head, Stubby, 12 mm	Art. 8017-5-WW
Ratchet Spanner; Flexi-Head, Stubby, 13 mm	Art. 8017-6-WW
Ratchet Spanner; Flexi-Head, Stubby, 14 mm	Art. 8017-7-WW
Ratchet Spanner; Flexi-Head, Stubby, 15 mm	Art. 8017-8-WW
Ratchet Spanner; Flexi-Head, Stubby, 16 mm	Art. 8017-9-WW
Ratchet Spanner; Reversible Switch, 10 mm	Art. 808-10-WW
Ratchet Spanner; Reversible Switch, 11 mm	Art. 808-11-WW
Ratchet Spanner; Reversible Switch, 12 mm	Art. 808-12-WW
Ratchet Spanner; Reversible Switch, 13 mm	Art. 808-13-WW
Ratchet Spanner; Reversible Switch, 14 mm	Art. 808-14-WW
Ratchet Spanner; Reversible Switch, 15 mm	Art. 808-15-WW
Ratchet Spanner; Reversible Switch, 16 mm	Art. 808-16-WW
Ratchet Spanner; Reversible Switch, 17 mm	Art. 808-17-WW
Ratchet Spanner; Reversible Switch, 18 mm	Art. 808-18-WW
Ratchet Spanner; Reversible Switch, 19 mm	Art. 808-19-WW
Ratchet Spanner; Reversible Switch, 20 mm	Art. 808-20-WW
Ratchet Spanner; Reversible Switch, 21 mm	Art. 808-21-WW
Ratchet Spanner; Reversible Switch, 22 mm	Art. 808-22-WW
Ratchet Spanner; Reversible Switch, 24 mm	Art. 808-24-WW
Ratchet Spanner; Reversible Switch, 8 mm	Art. 808-8-WW
Ratchet Spanner; Reversible Switch, 9 mm	Art. 808-9-WW
Ratchet Spanner; Aviation Type, Flexi-Head 8x10 mm	Art. 817-1-WW
Ratchet Spanner; Aviation Type, Flexi-Head 10x11 mm	Art. 817-2-WW
Ratchet Spanner; Aviation Type, Flexi-Head 12x13 mm	Art. 817-3-WW
Ratchet Spanner; Aviation Type, Flexi-Head 14x15 mm	Art. 817-4-WW
Ratchet Spanner; Aviation Type, Flexi-Head 16x18 mm	Art. 817-5-WW
Ratchet Spanner; Aviation Type, Flexi-Head 17x19 mm	Art. 817-6-WW
Ratchet Spanner; Ring&Ratchet, 8 mm	Art. 60035-8-WW
Ratchet Spanner; Ring&Ratchet, 10 mm	Art. 60035-10-WW
Ratchet Spanner; Ring&Ratchet, 12 mm	Art. 60035-12-WW
Ratchet Spanner; Ring&Ratchet, 13 mm	Art. 60035-13-WW
Ratchet Spanner; Ring&Ratchet, 14 mm	Art. 60035-14-WW
Ratchet Spanner; Ring&Ratchet, 17 mm	Art. 60035-17-WW
Ratchet Spanner; Ring&Ratchet, 19 mm	Art. 60035-19-WW
Ratchet Spanner; 8 mm	Art. 8009-1-WW
Ratchet Spanner; 9 mm	Art. 8009-2-WW
Ratchet Spanner; 10 mm	Art. 8009-3-WW
Ratchet Spanner; 11 mm	Art. 8009-4-WW
Ratchet Spanner; 12 mm	Art. 8009-5-WW
Ratchet Spanner; 13 mm	Art. 8009-6-WW
Ratchet Spanner; 14 mm	Art. 8009-7-WW
Ratchet Spanner; 15 mm	Art. 8009-8-WW
Ratchet Spanner; 16 mm	Art. 8009-9-WW
Ratchet Spanner; 17 mm	Art. 8009-10-WW
Ratchet Spanner; 18 mm	Art. 8009-11-WW
Ratchet Spanner; 19 mm	Art. 8009-12-WW
Ratchet Spanner; 21 mm	Art. 8009-14-WW
Ratchet Spanner; 22 mm	Art. 8009-15-WW
Ratchet Spanner; 24 mm	Art. 8009-17-WW
Ratchet Spanner; 27 mm	Art. 8009-20-WW
Ratchet Spanner; 30 mm	Art. 8009-23-WW
Ratchet Spanner; 32 mm	Art. 8009-25-WW



Ratchet Spanner; Flexi-Head, 8 mm	Art. 8010-1-WW
Ratchet Spanner; Flexi-Head, 9 mm	Art. 8010-2-WW
Ratchet Spanner; Flexi-Head, 10 mm	Art. 8010-3-WW
Ratchet Spanner; Flexi-Head, 11 mm	Art. 8010-4-WW
Ratchet Spanner; Flexi-Head, 12 mm	Art. 8010-5-WW
Ratchet Spanner; Flexi-Head, 13 mm	Art. 8010-6-WW
Ratchet Spanner; Flexi-Head, 14 mm	Art. 8010-7-WW
Ratchet Spanner; Flexi-Head, 15 mm	Art. 8010-8-WW
Ratchet Spanner; Flexi-Head, 16 mm	Art. 8010-9-WW
Ratchet Spanner; Flexi-Head, 17 mm	Art. 8010-10-WW
Ratchet Spanner; Flexi-Head, 19 mm	Art. 8010-11-WW
Ratchet Spanner; Flexi-Head, 19 mm	Art. 8010-12-WW
Ratchet Spanner; Flexi-Head, Stubby, 8 mm	Art. 8017-1-WW
Ratchet Spanner; Flexi-Head, Stubby, 9 mm	Art. 8017-2-WW
Ratchet Spanner; Flexi-Head, Stubby, 17 mm	Art. 8017-10-WW
Ratchet Spanner; Flexi-Head, Stubby, 18 mm	Art. 8017-11-WW
Ratchet Spanner; Flexi-Head, Stubby, 19 mm	Art. 8017-12-WW
Crowfoot Spanner; 1/2", 10 mm	Art. 4216-10-WW
Crowfoot Spanner; 1/2", 11 mm	Art. 4216-11-WW
Crowfoot Spanner; 1/2", 12 mm	Art. 4216-12-WW
Crowfoot Spanner; 1/2", 13 mm	Art. 4216-13-WW
Crowfoot Spanner; 1/2", 14 mm	Art. 4216-14-WW
Crowfoot Spanner; 1/2", 15 mm	Art. 4216-15-WW
Crowfoot Spanner; 1/2", 16 mm	Art. 4216-16-WW
Crowfoot Spanner; 1/2", 17 mm	Art. 4216-17-WW
Crowfoot Spanner; 1/2", 18 mm	Art. 4216-18-WW
Crowfoot Spanner; 1/2", 19 mm	Art. 4216-19-WW
Crowfoot Spanner; 1/2", 20 mm	Art. 4029-20-WW
Crowfoot Spanner; 1/2", 21 mm	Art. 4029-21-WW
Crowfoot Spanner; 1/2", 22 mm	Art. 4029-22-WW
Crowfoot Spanner; 1/2", 23 mm	Art. 4029-23-WW
Crowfoot Spanner; 1/2", 24 mm	Art. 4029-24-WW
Crowfoot Spanner; 1/2", 25 mm	Art. 4029-25-WW
Crowfoot Spanner; 1/2", 26 mm	Art. 4029-26-WW
Crowfoot Spanner; 1/2", 27 mm	Art. 4029-27-WW
Crowfoot Spanner; 1/2", 28 mm	Art. 4029-28-WW
Crowfoot Spanner; 1/2", 30 mm	Art. 4029-30-WW
Crowfoot Spanner; 1/2", 32 mm	Art. 4029-32-WW
Combination Spanner; 8 mm	Art. 8031-1-WW
Combination Spanner; 9 mm	Art. 8031-2-WW
Combination Spanner; 10 mm	Art. 8031-3-WW
Combination Spanner; 11 mm	Art. 8031-4-WW
Combination Spanner; 12 mm	Art. 8031-5-WW
Combination Spanner; 10 mm	Art. 8031-6-WW
Combination Spanner; 14 mm	Art. 8031-7-WW
Combination Spanner; 15 mm	Art. 8031-8-WW
Combination Spanner; 16 mm	Art. 8031-9-WW
Combination Spanner; 17 mm	Art. 8031-10-WW
Combination Spanner; 18 mm	Art. 8031-11-WW
Combination Spanner; 19 mm	Art. 8031-12-WW
Combination Spanner; 21 mm	Art. 8031-16-WW
Combination Spanner; 22 mm	Art. 8031-17-WW
Combination Spanner; 23 mm	Art. 8031-18-WW
Combination Spanner; 24 mm	Art. 8031-19-WW
Combination Spanner; 25 mm	Art. 8031-20-WW
Combination Spanner; 26 mm	Art. 8031-21-WW
Combination Spanner; 27 mm	Art. 8031-22-WW
Combination Spanner; 28 mm	Art. 8031-23-WW
Combination Spanner; 30 mm	Art. 8031-24-WW
Combination Spanner; 32 mm	Art. 8031-25-WW



Single Socketry

Spanner; Aviation Type, Double Ring, 8x9 mm	Art. 816-7-WW
Spanner; Aviation Type, Double Ring, 8x10 mm	Art. 816-1-WW
Spanner; Aviation Type, Double Ring, 10x12 mm	Art. 816-8-WW
Spanner; Aviation Type, Double Ring, 11x13 mm	Art. 816-2-WW
Spanner; Aviation Type, Double Ring, 14x15 mm	Art. 816-3-WW
Spanner; Aviation Type, Double Ring, 16x17 mm	Art. 816-4-WW
Spanner; Aviation Type, Double Ring, 18x19 mm	Art. 816-5-WW
Spanner; Aviation Type, Double Ring, 21x23 mm	Art. 816-9-WW
Spanner; Aviation Type, Double Ring, 22x24 mm	Art. 816-6-WW



SINGLE SOCKETS & WRENCHES

POPULAR SIZES FROM SETS

Can't find what you're looking for? Give us a call and we may be able to arrange stock of additional single units & sizes.



WORKSHOP TOOLS



Creeper & Seat for Mechanics

Clothing and Safety > Job Safety

With double ball bearing rolling wheels.
Persistent synthetic leather padded cover.
Converts easily from creeper to seat and back, adjustable.
Seat surface: 320 x 310 mm.
Seat height: 445 mm.
Lying surface: 1060 x 310 mm (with headrest).



Art. 7056-WW

Creeper Seat; Welzh

Clothing and Safety > Job Safety

Padded mobile mechanics seat.
3 partition divider tray, ideal for storing tools during and before use.
Fluid roller wheels for smooth movement around the workshop.
37cm height.
35cm width.



Art. 7012-WW

Support Hook; Universal

Clothing and Safety > Job Safety

The Universal Support Hook can be your third hand to hold the steering Knuckle or brake caliper, prevent the oil pipe or wire be tearing.



Art. 7021-WW

Uni-Support Hook: 4-Piece Kit

Clothing and Safety > Job Safety

Uni-Support Hooks.
4-Piece Kit.
Universal Use on applications such as, Brake Calipers, Cables, Hose etc.
x2 Solid Hooks.
x2 Flexible Hooks.
Features a Steel Spring Core and Protective Rubber Coating.

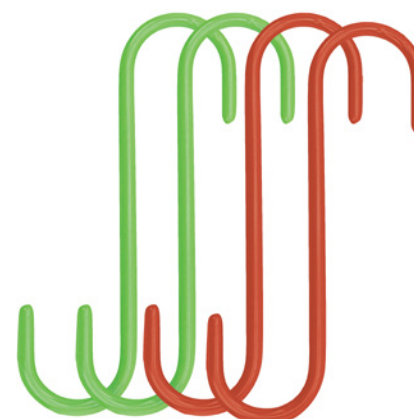

Art. 91007-WW

Mechanics Knee Protection Matt With EVA Technology

Clothing and Safety > Job Safety

Dimensions: 480 x 320 x 36 mm.
Oil, acid and fuel resistant.
EVA foam.



Art. 7007-WW

Mechanics Working Mat With EVA Technology

Clothing and Safety > Job Safety

Dimensions: 1150 x 550 x 36 mm.
Acid Resistant EVA foam.
Extra large size makes this perfect when work under vehicles.
Must have item for the workplace.
Available in black or green.



Black: Art. 826-WW

Green: Art. 826-1-WW

Mechanics Working Kneel Mat With EVA Technology & LED Lighting

Clothing and Safety > Job Safety

Made from EVA oil and acid resistant foam.
Fitted with super bright LED strips.
Ideal for working under vehicles where light can be an issue.
Dimensions: 460x270x30 mm.



Art. 4046-WW

Mechanics Foldable Work Matt

Clothing and Safety > Job Safety

Four way folding mat.
Size: 1800 x 430mm x 100mm.
Head/neck rest for comfort.
Handles for manoeuvrability & storage.



Art. 4064-WW

Gloves; Mechanics Style, Size: L

Clothing and Safety > Job Safety

Ideally suited for: tire service, automotive, assembly, industrial.
Coated palm and finger area ensures secure grip.
Velcro band.
Professional quality.



M Art. 35102-WW

L Art. 35100-WW

XL Art. 35101-WW

Welding Helmet (Skull Version) Green; Automatic

Clothing and Safety > Job Safety

Photoelectric liquid crystal light control.
Field of view: 92 x 42 mm.
Cassette size: 110 x 90 x 9 mm.
Switching time 1/25000 sec.
Time from dark to light 0.1 - 1.0 sec.
Deactivated status: DIN 4.
Activated status: DIN 9 - 13.
External regulator for variable protection stages.
Two internal regulator for variable sensitivity and delay.
Power supply: battery CR2032.
UV / IR protection DIN 16.
Arc sensor 2.
Low-amp TIG => 5 Amp.
Display for low-battery.
ADF self-test.

Art. 810-2-WW



Welding Helmet (Skull Version); Automatic

Clothing and Safety > Job Safety

Photoelectric liquid crystal light control.
Field of view: 92 x 42 mm.
Cassette size: 110 x 90 x 9 mm.
Switching time 1/25000 sec.
Time from dark to light 0.1 - 1.0 sec.
Deactivated status: DIN 4.
Activated status: DIN 9 - 13.
External regulator for variable protection stages.
Two internal regulator for variable sensitivity and delay.
Power supply: battery CR2032.
UV / IR protection DIN 16.
Arc sensor 2.
Low-amp TIG => 5 Amp.
Display for low-battery.
ADF self-test.

Art. 810-WW



Welding Helmet (Flame Pattern)

Clothing and Safety > Job Safety

Suitable for ARC, TIG, MIG, Spot, Micro, Wire, AC, DC, and Plasma Welders and Plasma Cutters.
Power supply: Solar cells, batteries change required 2 X CR2032 lithium batteries.
Power on/off: Fully automatic.
Delay time: 0.2-0.8s adjustable.
Filter size: 110x90x9mm.
Viewing Area: 92x42mm.
Switch time: 1/25000s.
Light state: DIN.4.
Dark state: DIN.9-13.
Shade knob: Out.
Arc sensor: 2 pieces.
Welding helmet weight: 500g.

Art. 800095-UTC



Recovery Tie Down Straps 3000Kgs With Anti-Slip Protector

Clothing and Safety > Job Safety

Suitable for up to 3000kg (3 Metric tonnes).
Anti-Slip protection cover on the straps.
6 metres in length.
Durable and long lasting.



Art. 814-WW

Adaptor For VAG Models For use with 2887-WW

Garage Equipment > Fluid and Extraction Equipment

New updated adaptor for VAG Models.
For use with 2887-WW.
For Use On: VW-Golf, Polo, Jetta, Passat, Seat- Leon, Skoda-Ocatvia, Fabia.



Art. 2887-1-WW

Car Engine Oil Filling Device with Adapters

Garage Equipment > Fluid and Extraction Equipment

Allows for fast oil filling without spillage.
Great for many late model vehicles with internal baffles.
2 litre funnel fits adapters for wide application range.
Colour-coded adapters for oil filler hole.
Special angled extension with swivel feature for hard-to-reach places.
Applications: Audi, BMW, Citroen, Ford, SEAT, Skoda, Peugeot, Renault, Vauxhall, VW etc.



Art. 2887-WW

Fluid Extractor Manual 6-Litres

Garage Equipment > Fluid and Extraction Equipment

Can be operated via pneumatic air system or hand pump.
Transparent body to for visibility of the fluid during use.
Suitable for fluid evacuation.
Can be used for, Petrol , Diesel Oil Etc
Multipile Adators
Maintenance free.
Features: 6ltr Capacity.



Art. 4010-WW

70 Litre Waste Oil Drain Receiver

Garage Equipment > Fluid and Extraction Equipment

Designed for containing waste oils, such as on engines, gearboxes, rear axles, etc.
Compressed air connection, makes it easier to empty the container without oil spillage.
Hopper capacity: 8 litres (Ø 48 cm).
4 castors, 2 swivel wheels for easy manoeuvring (Ø 150 / 75 mm).
Includes emptying hose.
Length 165 cm.
Min. Height: 112 cm.
Max. Height: 162 cm.
Container: Ø 41 cm / height 82 cm.



Art. 60072-WW

70 Litre Mobile Suction Evac Oil Drainer, Air support

Garage Equipment > Fluid and Extraction Equipment

Sucking speed: 0.6-1.6L/Min.
Work pressure: 7-8Bar.
Collecting height: 1.85m.
Tack capacity: 90L.
Capacity of measuring cup: 10L.
Length of suction pipe: 1.5m.
Length of drainpipe: 2.0m.
Total weight: 37kgs.
Overall dimension: 500x500x500.
Fixed wheel: 7".
Swivel castor: 4".
Function: Multi-function: oil sucking, oil collecting & oil filling.
Additional large oil tray convenient for oil collecting.

Easy use to drain oil in low pressure.
Transparent measuring cup for easy oil observation.
Different type of nozzles is equipped for various condition.



Art. 60073-WW

Fluid Extractor Manual & Air Operational 10-Litres

Garage Equipment > Fluid and Extraction Equipment

Can be operated via pneumatic air system or hand pump.
Transparent body to for visibility of the fluid during use.
Suitable for fluid evacuation.
Can be used for, Petrol , Diesel Oil Etc
Multiple Adaptors
Maintenance free.
10L capacity.



Art. 7062-WW

2-Piece Universal Oil Funnel Set

Garage Equipment > Fluid and Extraction Equipment

Designed to fit the majority of oil intakes.
The specially designed clamp can be adjusted to fit.
Minimise spilling and mess.
Stable and secure fitting.



Art. 4013-WW

Oil Mate 16-Litre Oil Pan & Holder For Transmission Jack

Jacking and Lifting > Transmission Jack Accessories

This tool is an indispensable assistance with automotive oil work, ensuring quick, clean changes and easy drainage.

Oil mate's mounting point fits standard European transmission jacks.

Tilting oil pan is removable and replaceable (71002-WW & 71001-WW).

Anti-spill inner rim and triple channel spout flow system help minimise spills.

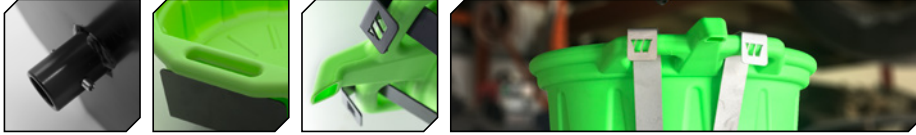

Art. 3100-WW

16-Litre Fuel Pan

Garage Equipment > Fluid and Extraction Equipment

Made from HDPE oil and fuel resistant plastic.

Impact resistant.

Diameter: 570 mm.

Height: 120 mm.

Weight: 1075g.



Art. 71002-WW

16-Litre Oil Pan

Garage Equipment > Fluid and Extraction Equipment

Made from HDPE oil and fuel resistant plastic.

Impact resistant.

Diameter: 570 mm.

Height: 120 mm.

Weight: 1075g.



Art. 71001-WW

12 Volt Oil Pump

Garage Equipment > Fluid and Extraction Equipment

Max. flow rate for engine oil approx. 0,2l /min.

Ideal equipment for quick and clean oil-changes.

The oil-pump works by connecting the clamps to the 12V car battery.

Can remove 100% of the used oil if inserted through the dipstick opening.

Complete with all necessary accessories.

Max. suction lift height: 70 cm.

Not suitable for fuel and other easy flammable fluids.



Art. 9910-WW

Booster Pack; Mini Type, 12v

Garage Equipment > Booster Packs

Diesel engines: up to 3.0l.
Petrol engines: up to 6.5l.
Mains or 12v charging.
Specifications.
Dimensions: 17 x 18 x 15.5 cm.
Weight: 5.1kg.
Digital meter: display voltage 3 to 30 v.
Output: 12v(DC) max/ 10A : 5v USB/max 2A.
Instant max current 1200A.
Charging power: AC 100-240v, 50/60Hz, CE/UL,PSE.
Battery: ACID, DC 12v/14aH.
Cold Cranking Amps: 800.
Replacement Battery: 1120-BATTERY-WW.
Replacement Charger: 1120-CHARGER-WW.

Art. 1120-WW



Booster Pack, Extreme Heavy Duty; 12/24v

Garage Equipment > Booster Packs

Automatic charger with smart circuit which allows the unit to be left in continuous charge without incurring damage.
Superior quality components guarantee reliability and high levels of safety.
Starts up to 30 cars before recharging is needed*.
LED Power level indicator.
Impact resistant, durable and robust casing.
12v/24v.
Replacement Charger: 1121-P4-WW.
Replacement Battery: 1121-P3-WW.

Art. 1121-WW



Booster Pack, Extreme Heavy Duty; 12v

Garage Equipment > Booster Packs

Automatic charger with smart circuit which allows the unit to be left in continuous charge without incurring damage.
Superior quality components guarantee reliability and high levels of safety.
Starts up to 30 cars before recharging is needed*.
LED Power level indicator.
Impact resistant, durable and robust casing.
12v.
Replacement Charger: 1121-P4-WW.
Replacement Battery: 1121-P3-WW.

Art. 1122-WW



Universal Engine Support

Garage Equipment > Battery Boosters

2- and 3-point support on car wing edges and hood latch
Wide area of application due to adjustable suspension points Complete with 2 pendant ropes
Capacity: 315 kg
Cross beams width: 1000 - 1550mm
Longitudinal beam length: 24-fold adjustable
90, 120, 150, 180, 210, 240, 270, 300, 330,
360, 390, 420, 450, 480, 510, 540, 570, 600,
630, 660, 690, 720, 750, 780 mm
Supporting foot height (longitudinal beam):
100-130 - 160-185 - 210-240 mm
Supporting foot height (crossbeams): 105 mm

Art. 1129-WW



Digital Battery Tester

Diagnostic > Electrical Diagnostics

For testing vehicle batteries, charger and starter systems.
Suitable for 12v batteries with cold start current 200 to 1000 a.
3-Digit digital voltage display.
Battery condition is shown via 3 led.
Load current: 125 ampere.
Test cable length: 48



Art. 4099-WW

Jump Leads; Heavy Duty, 6m

Garage Equipment > Booster Cables

Six metres in length.
Insulated grips.
Durable and long lasting.
Made with high quality materials designed to last.
Heavy duty construction.



Art. 1202-WW

Jump Leads; Heavy Duty, 6m, 800 amp

Garage Equipment > Booster Cables

Rated Voltage: 12/24V DC.
800AMP/50MM².
Length: 6 Meters.



Art. 60055-WW

Induction Rope Wire for Induction Heater

Garage Equipment > Heat Induction

For heating flanges, bearing housing, shafts, gears, exhaust connections, etc.
Malleable, therefore universal application.
Wire diameter: 4 mm.
Wire length: 800 mm.

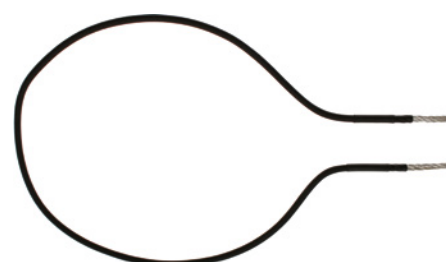

Art. 2169-3-WW

Induction Heater UK Plug

Garage Equipment > Heat Induction

There is an alternating magnetic field.
The metallic object (e.g. nut), in the induction coil, acts on the induced eddy currents as an electrical resistance and thus heats up.
Allows heating of screws / nuts without severely heating surrounding components or even destroying them, as it is often the case when heated with a torch.
Within the shortest possible time, e.g. rusty nuts are heated and can be loosened.
Using for e.g. ball joint pinch bolts and other items on axle and engine.
Also for heating components such as bearings.
Includes the following induction coils inductive coil 19 mm, 220 mm long (for Ø 10-16mm)
Inductive coil 27 mm, 220 mm long (for Ø 17-24 mm) inductive coil 50 mm, 235 mm length.
(for heating small surfaces) formless coil, 780 mm, for heating of components (bearings, etc.).
Dimensions: 200 x 140 x 75 mm.
Power supply: ~230V (50-60Hz).
Current: 7.5 Amps.
Max. Power: 1.5 kw.



Art. 2169-WW

Induction Heater EU Plug

Garage Equipment > Heat Induction

There is an alternating magnetic field.
The metallic object (e.g. nut), in the induction coil, acts on the induced eddy currents as an electrical resistance and thus heats up.
Allows heating of screws / nuts without severely heating surrounding components or even destroying them, as it is often the case when heated with a torch.
Within the shortest possible time, e.g. rusty nuts are heated and can be loosened.
Using for e.g. ball joint pinch bolts and other items on axle and engine.
Also for heating components such as bearings.
Includes the following induction coils inductive coil 19 mm, 220 mm long (for Ø 10-16mm)
Inductive coil 27 mm, 220 mm long (for Ø 17-24 mm) inductive coil 50 mm, 235 mm length.
(for heating small surfaces) formless coil, 780 mm, for heating of components (bearings, etc.).
Dimensions: 200 x 140 x 75 mm.
Power supply: ~230V (50-60Hz).
Current: 7.5 Amps.
Max. Power: 1.5 kw.



Art. 2169-1-WW

8-piece Induction Coil Set, Flat Type, for Induction Heater

Garage Equipment > Heat Induction

For heating of screws, nuts, shafts, etc.
90° angled type.
Wire diameter: 4 mm.
Coil width: approx. 23 mm.
Overall length: approx. 230 mm.
Includes coils with the following internal diameters: 15 - 19 - 20 - 23 - 27 - 33 - 39 - 47 mm.



Art. 2169-2-WW

8-piece Induction Coil Set for Induction Heater

Garage Equipment > Heat Induction

Includes coils with the following internal diameters: 15 - 19 - 20 - 23 - 27 - 33 - 39 - 47 mm.
For heating of screws, nuts, shafts, etc.
Overall length: approx. 220 mm.
Coil height: approx. 23 mm.
Wire diameter: 4 mm.
Straight type.



Art. 2169-4-WW

LED Magnetic Tray

Garage Equipment > Garage Storage

150 mm in diameter with a stainless steel finish.
The magnet supplied is very strong with a rubber covering to stop scratches to potentially expensive parts.
The versatile Tri-LED light prove extremely useful when space is an issue.
Perfect when working on vehicles with small parts.



Art. 30892-WW

Magnetic Tray

Garage Equipment > Garage Storage

150 mm in diameter with a stainless steel finish.
The magnet supplied is very strong with a rubber covering to stop scratches to potentially expensive parts.
Perfect when working on vehicles with small parts.



Art. 30894-WW

Magnetic Tray Double

Garage Equipment > Garage Storage

The magnet supplied is very strong with a rubber covering to stop scratches to potentially expensive parts.
Perfect when working on vehicles with small parts.
Stainless steel finish.



Art. 30895-WW

Extra Large Magnetic Tray Quad

Garage Equipment > Garage Storage

Extra strong rubber covered magnet to protect connecting surfaces.
Stainless steel finish.



Art. 30897-WW

Magnetic Air Tools Holder

Holds air impact wrenches, wheel nut sockets and torque wrenches on lifting platforms.
2 strong magnets.
15 kg lifting capacity.

Garage Equipment > Garage Storage



Art. 7053-WW

Extra Deep Magnetic Tray

All purpose: use in workshop, construction, car-repair, etc. special high finish allows storing of non-magnetic small parts like aluminium, brass, stainless steel as well as large magnetic tools and very strong magnets, rubber coated.

Garage Equipment > Garage Storage



Art. 30898-WW

Retractable Power Cable Reel 13m for Electrical Tools UK fittings

Cable length: 15m + 1.5m.
Working Voltage: AC250V.
Amps: 16 A / 50 Hz.
No suitable for outdoor use.
Can be locked in any position.
Over heat protection.
Can be wall mounted.
Can be used in workshops or at home.

Garage Equipment > Electrical Equipment



Art. 829-WW

Retractable Power Cable Reel 13m for Electrical Tools EU fittings

Cable length: 15m + 1.5m.
Working Voltage: AC250V.
Amps: 16 A / 50 Hz.
No suitable for outdoor use.
Can be locked in any position.
Over heat protection.
Can be wall mounted.
Can be used in workshops or at home.

Garage Equipment > Electrical Equipment



Art. 828-WW

4-Piece Magnetic Trays

Garage Equipment > Garage Storage

Multiple Magnets on each tray provide strength and stability.
Rubber coated magnets protect from scratching.

Use in workshop, construction, car repair etc.

Sizes:

310x110x120mm.

270x110x120mm.

210x110x120mm.

150x110x120mm.

Tray Depth: 30mm.



Art. 60049-WW

MAGNETIC STORAGE SHELVES & TRAYS

SOFT COATED MAGNETS PROTECT SURFACES

Our range of magnetic trays and shelves are great for keeping track of small parts and tools while you work and go perfectly with our tool cabinets.



Display Stand WELZH

High strength shelving unit ideal for display and support of heavy tools and cases.
Highly durable, versatile shelving units can be fitted in 5cm increments.
Perforated back panels fit 3mm hooks in 7mm increments.
Height: 2240 mm.
Length: 1030 mm.
Width: 550 mm.
Weight: 49.4 kg.

Garage Equipment > Tool Cabinets

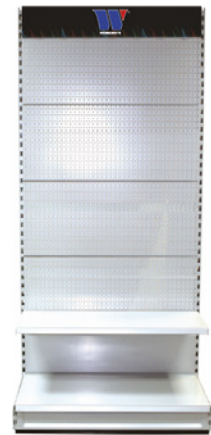

Art. 2476-WW

Workshop Table with Drawer; Fully Adjustable

Features a rubberized top surface to prevent damage to tools and the table.
Top section has 4 compartments helping to keep parts safe and well organised.
Height: 930 to 1260 mm.
Width: 440 x 510 mm.
360 degree rotation.
Capacity: 90 kg.
Suitable for use when sitting or standing in both garage and workshop environments.
Heavy duty castors.

Garage Equipment > Tool Cabinets



Art. 91003-WW

XL Tool Cart 3-Drawed With Lockable Lid (Green)

Professional quality workshop trolley with 2 shelves.
Spring hinge lid.
Heavy duty drawer construction; top shelves: 40kg capacity, bottom shelves: 50kg.
Two lower storage shelves with a 50kg capacity each, can be installed base down or base up to give either tool and component security or unobstructed access.
Features a quick access tool holder; perfect for storing commonly used tools such as screwdrivers.
Fitted with heavy duty caster with locks.
Dimensions (WxDxH).
Overall Size: 925 x 440 x 900mm.
Shelf Size (x2): 760 x 435 x 60mm.
Medium Drawer (x1): 560 x 400 x 65mm.
Medium Drawer (x1): 560 x 400 x 85mm.
Upper Tray Size: 585 x 435 x 75mm.
Total Load Capacity: 150kg.

Garage Equipment > Tool Cabinets



Art. 91006-WW

XL Tool Cart 3-Drawed With Lockable Lid (Black)

Professional quality workshop trolley with 2 shelves.
Spring hinge lid.
Heavy duty drawer construction; top shelves: 40kg capacity, bottom shelves: 50kg.
Two lower storage shelves with a 50kg capacity each, can be installed base down or base up to give either tool and component security or unobstructed access.
Features a quick access tool holder; perfect for storing commonly used tools such as screwdrivers.
Fitted with heavy duty caster with locks.
Dimensions (WxDxH).
Overall Size: 925 x 440 x 900mm.
Shelf Size (x2): 760 x 435 x 60mm.
Medium Drawer (x1): 560 x 400 x 65mm.
Medium Drawer (x1): 560 x 400 x 85mm.
Upper Tray Size: 585 x 435 x 75mm.
Total Load Capacity: 150kg.

Garage Equipment > Tool Cabinets



Art. 91005-WW

Hand Held Gas Torch

Garage Equipment > Gas Torches and Heating

Piezo ignition.
Locking trigger and flame lock.
Adjustable flame.
10g gas tank capacity.
1300 °C working temperature



Art. 8030-WW

Swivel Base For Transmission Jack

Jacking and Lifting > Transmission Jack Accessories

Standard European transmission jack fitting on base.
Adjustable chain length for universal application.



Art. 997-1-WW

Jack; 2-Ton Pneumatic, Bellow

Jacking and Lifting > Other Jacks

This product is designed for lifting vehicles at maximum height of 300mm and minimum of 120mm.
Compact and lightweight.
Lifts load with compressed air.
Uses 105 psi of air pressure max.



Art. 4038-WW

Jack; 2-Ton Extended Pneumatic, Bellow

Jacking and Lifting > Other Jacks

This product is designed for lifting vehicles at maximum height of 400mm and minimum of 140mm.
Compact and lightweight.
Lifts load with compressed air.
Uses 105 psi of air pressure max.



Art. 4039-WW

Car Ramps Low Profile (2-Piece Set)

Jacking and Lifting > Other Jacks

Manufactured from Polypropylene (PP) Size 700(l)x200(w)x 70mm(h) with 80mm end stop.
Capacity 4000kg per pair.
Ideal for low sports cars to get access for trolley jacks, light and easy to store.
When two pairs are used they are ideal for classic car storage lifting the car and preventing the build up of moisture under the tyres.

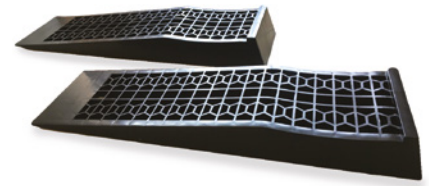

Art. 7068-WW

Hydraulic Car Dolly Jack

Jacking and Lifting > Other Jacks

Car Dolly Jack Allows for the easy moving of damaged vehicles load capacity 680 kg per jack
tire width up to max. 295 mm ground clearance: 150 mm max. lifting roll distance: 550 mm
(extended)min. lifting roll distance: 270 mm (retracted)dimensions (retracted): 345 x 630 mm
dimensions (extended): 800 x 630 mm.
Available separately:
7081-1-WW: Replacement Hydraulics.
7081-2-WW: Replacement Wheel.



Art. 7081-WW

Wheel Dollies 2-Piece Set

Jacking and Lifting > Other Jacks

Ideal for manoeuvring in small areas, for example with 4 steel castor wheels lateral struts prevent
the tyre from slipping max. tyre width: 360 mm dimensions: 385 x 605 mm.
Capacity per piece: 450 kg.
Replacement Wheels; 7082-1-WW



Art. 7082-WW

Transmission Jack; 600 kg, Heavy Duty

Jacking and Lifting > Transmission Jacks

For assembling and disassembling of gearboxes, rear axles and suspension parts.
Swivel saddle.
Height 1130 to 1970 mm.
4 ball bearing castors.
Heavy duty construction.
840 mm stroke.
Quick lift hydraulic foot pump.
Weight 34 Kg.



Art. 4055-WW

Transmission Jack; 500 kg

Jacking and Lifting > Transmission Jacks

This hydraulic transmission jack can be used when assembling and disassembling parts which need to be lifted, descended or transported.

This jack is a movable hydraulic jack with the following advantages:

Compact construction.

Light weight.

Long lifting range.

Max weight 500kg.



Art. 4056-WW

Transmission Jack 500kg; Telescopic Vertical

Jacking and Lifting > Transmission Jacks

For assembling and disassembling engines, gearboxes and rear axles.

Adjustable head plate 60 mm to the side and from -10° to 35°; in inclination, therefore especially suitable for mounting of automatic transmissions.

Height approx. 880 to 1770 mm.

4 ball bearing caster wheels.

Compact construction, lightweight.

High lifting range.

Fast lifting due to hydraulic foot pedal.



Art. 997-WW

Trolley Jack; Mobile Type; Air Hydraulic, 20 ton

Jacking and Lifting > Trolley Jacks

Capacity: max. 22 ton.

Min. height: 260 mm.

Max. height: 435 mm.

Piston stroke: 120 mm.

4 attachments for different min. and max. heights:

Ø 48 mm, length 20, 60 and 100 mm.

Ø 68 mm, length 25 mm.

80 mm lifting spindle, adjustable.



Art. 60069-WW

Trolley Jack; Aluminium, 2.5 ton

Jacking and Lifting > Trolley Jacks

Dual lifting piston.

Durable and lightweight aluminium / steel construction.

Min. height: 100 mm.

Max. height: 460 mm.

Rear height: 155 mm.

Length: 640 mm.

Width: 285 mm.

Weight: 26.6 kg.

Front castors: Ø 65 mm.

Steering castors: Ø 45 mm.



Art. 78905-WW

Trolley Jack; 3.5 ton, Heavy Duty

Jacking and Lifting > Trolley Jacks

Double action mechanics.
Strength, lightweight aluminium & steel structure.
Product Size: 760x355x160mm, Length: 698.5mm, Weight: 42.5 Kg.
Min Range: 82mm.
Max Range: 525mm.
50" handle for easier pumping whilst under load.



Art. 78912-WW

Trolley Jack; 3 ton, Heavy Duty

Jacking and Lifting > Trolley Jacks

3-Ton max lifting capacity.
145mm to 520mm lifting range.
Perfect for loaded vans up to 3.5 Ton GVW.
Twist handle release mechanism.
Heavy duty rear castors & large saddle aid positioning.
Weight: 37.4kg.



Art. 998-WW

Bottle Jack; Hydraulic, 20T

Jacking and Lifting > Bottle Jacks

Idea for use in workshops and garages.
Hand operated.
Capacity: 20 ton.
Min height: 244 mm.
Max height: 449 mm.



Art. 78911-WW

Bottle Jack; Air & Hydraulic, 20T

Jacking and Lifting > Bottle Jacks

Designed for operating either manually or pneumatically heavy-duty steel construction meets ANSI standards.
Available air pressure: 80 PSI to 120 PSI 20 ton lifting capacity.
Extension screw gives added height when necessary.
Fitted with safety valve to prevent overloading.
Two-piece handle allows for easy pumping.
Air hose can swivel in any direction.
Double spring return.
Min. height: 10 3/16in.
Max. height: 19 7/8in.



Art. 800017-UTC

Bottle Jack; Stubby, Air & Hydraulic, 20T

Jacking and Lifting > Bottle Jacks

20 ton capacity makes it suitable for many applications.
Air intake: 110-175 psi @ 7.8 CFM.
Min height: 205 mm.
Max height: 400 mm.



Art. 827-WW

Portable Power Kit; 4-Ton

Presses > Hydraulic Press

For special operations on car bodies and fenders.
75 mm hydraulic cylinder pressing width.
350 mm hydraulic pump length.
Maximum pressure: 4 tons.
Many accessories.



Art. 60910-WW

Porta Power Kit; 10-Ton

Presses > Hydraulic Press

For special operations on car bodies and fenders.
Maximum pressure: 4 tons.
Many accessories.



Art. 60911-WW

Puller Set; 10 ton Hydraulic

Pullers and Installers > Hydraulic Pullers

Hydraulic ram 10 ton (4148-WW).
2 extension rods one twin head and one triple head.
3 legs each in following lengths: 100, 150 and 200 mm.
Max. pulling width: 240 mm with 100 mm pulling leg length.
280 mm with 150 mm pulling leg length.



Art. 4102-WW

Replacement Bolts And Nuts For 40016 & 40017

Presses > Pressing Accessories

Replacement bolts & nuts for 40016-ww and 40017-ww.



Art. 40016-1-WW

Universal Press Support Mate

Presses > Pressing Accessories

Allows for a quick solution to assist in the removal of wheel bearings working with the Hydraulic Press.
For use with WELZH 40017-WW.
The large diameter is ideal for holding hubs and pressing out wheel bearings.
0 Great Alternative then traditional V blocks and old bearing casings.
Diameter 160mm (H) 177mm (ø).



Art. 3300-WW

Universal Press Support Blue*

Presses > Pressing Accessories

The special design of the block allows the pins to be adjusted to suit almost all components.
When paired with a shop press such as Art. 824 it will become an invaluable piece of kit.
3 point contact provide a safe and secure point of contact.
Capacity: 20 ton.



Art. 40017-WW

UNIVERSAL PRESS SUPPORT MATE™

3300-WW & 40017-WW

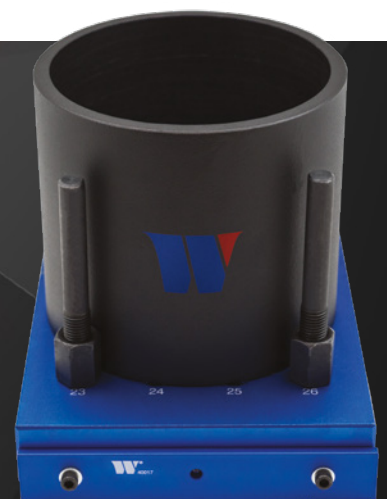

Press for Workshops; 10 ton

Jacking and Lifting > Workshop Press

For removal and installation of bearings, bushings, etc.
 Suitable for fixed mounting on e.g. workbenches.
 Dimensions: (H) 1075 x (W) 620 x (D) 450 mm.
 3-way adjustable support beam.
 Can be used on work-pieces up to following dimensions:
 Width: 345 mm.
 Height: 170 to 330 mm.
 Stroke of hydraulic cylinder: 90 mm.
 Adding a Universal Press Block will expand the amount of applications.
 Available separately:
 8026-1-WW: Replacement Hydraulic pump.
 8026-2-WW: Replacement gauge.



Art. 8026-WW

Hydraulic Ram For Pullers & Extractors; 12-Ton

Pullers and Installers > Hydraulic and Air Pullers

12-Ton Hydraulic Ram.



Art. 4148-WW

Linch Pin Assortment - 50-Pieces

Small Parts and Consumables

Galvanized & Zinc coated.
 Includes the following Sizes:
 Linch pin 16 x 4.5 mm.
 Linch pin 18 x 6.0 mm.
 Linch pin 6 x 8.0 mm.
 Linch pin 10 x 11.0 mm.



Art. 8399-WW

Hose Connector Kit; Plastic, 113 pcs

Small Parts and Consumables

Straight Connectors:
 (30) 1/8" x 1/8".
 (10) 3/16" x 3/16".
 (8) 1/4" x 1/4".
 (6) 5/16" x 5/16".
 (6) 3/8" x 3/8".
 Straight Reducers:
 (10) 1/4" x 3/16".
 (6) 3/8" x 1/4".
 Tee Connectors:
 (12) 1/8".
 (8) 5/32".
 (8) 3/16".
 (6) 1/4".
 (3) 3/8".



Art. 8940-WW

LIGHTING



PROFESSIONAL LED HAND LAMPS

SIRIUS RANGE



Sirius Range LED Hand Lamps

Unique 180° rotate function enables the light source to be positioned in any direction. Each lamp contains seven super bright SMD LEDs which provides an impressive 350 lumens at a light spread of 120° providing ample light for most situations. The lamp also features a top inspection lamp rated at 3W. Two swivel hooks, 2 rubberised rear magnets, and a bottom mounted magnet gives multiple ways to position and store the lamp giving easy hands free access. Equipped with a superior 2.2Ah Lithium-Ion battery for long life. Charges via any micro USB - can be used with mains or directly into a USB port. Includes mains charger and USB lead. Length: 255 mm.

Hand Lamps > Sirius Range



■ Art. 786-WW

■ Art. 787-WW

■ Art. 788-WW

Sirius Range LED Hand Lamps - Mini Range

Hand Lamps > Sirius Range

Compact, lightweight and versatile - perfect for the busy workshop environment or home use. Unique 180° rotate function enables the light source to be positioned in any direction. Each lamp contains seven super bright SMD LEDs which provides an impressive 220 lumens providing ample light for most situations. The lamp also features a top inspection lamp rated at 1W. A swivel hook, 2 rubberised magnets, and swivel bottom gives multiple ways to position and store the lamp giving easy hands free access. Equipped with a superior 1.5Ah Lithium for long life. Charges via any micro USB - can be used with mains or directly into a USB port. Includes mains charger and USB lead.



■ Art. 791-WW

■ Art. 790-WW

■ Art. 792-WW

Slim Line Multifunction Rechargeable Inspection Work Light

Hand Lamps > Other Hand Lamps

Slim design allows for use in hard to use spaces.
SMD work light with top light function.
3 LED's battery level & charging indicator.
Front light: High/Low: 600/240 lm, 6hrs.
Top light: High/Low: 120 lm, 10hrs.
USB charging with USB charger.
120 degree rotation.
Magnetic base.



Art. 793-WW

Shock Resistant Hand Lamp with Scratch Resistant Lens

Hand Lamps > Other Hand Lamps

Shock proof multi-function work-light with USB charging.
Dual hooks and magnets allows it to be placed while using other tools.
3w COB light and 3W top lamp product ample brightness.
180 degree base rotations with high powered base magnet.
Protective rubber coating.
Sunken lens prevents scratches increasing longevity.



Art. 785-WW

Art. 783-WW

Rechargeable LED Headlight

Hand Lamps > Head Lamps

Motion sensor for hands free activation while working.
Adjustable strap with rubber grip strip to prevent loose movement.
Durable protective outer casing, buttons and USB port cover.
Charged via micro USB cable.
Two brightness options.



Art. 794-WW

16 SMD Strip Working Light

Hand Lamps > Other Hand Lamps

SMD LED delivers 230 Lumens of light with an output.
SMD LED lifetime- 50000 hrs 3.7v.
Ultra Thin compact & rugged design only weighs 0.25 pounds.
1300mah li-ion battery with docking charging station.
Light has 16 high efficiency.



Art. 818-WW

Hood Light; Telescopic, Cordless, LED

Workshop Lamps > Hood Lights

Robust and durable design - perfect for the busy workshop environment.
The attachment hooks are padded and polymer coated to prevent damage to the bonnet.
120 LEDs with a 120° spread of light provides ample illumination of the engine bay - or where ever it is used.
Lithium-Ion battery provides longer life; 7.4V / 2.0Ah.
Capacity: 7W.
Width range: 1290 - 2190 mm.
Operating time: approx. 4h.
Charging time: approx. 6h.
Includes 230V and 12V charger.



Art. 8114-WW

Hood Light; Telescopic, Corded

Workshop Lamps > Hood Lights

Fluorescent tube type T8, 30 watt (890 mm).
Telescopic bar, extends 110 to 190 cm.
Extra long power cord: 4.5 m (230 V).
360° swivel hook.



Art. 8113-WW

Mechanics Hat With Led Light

Workshop Lamps > Hood Lights

Button Battery operated
Light has three levels Level
Up 25 hour use.



Art. 35103-WW

Category	Page
Air Lines > Air Hose	8 - 10
Air Lines > Air Line Accessories	8
Air Lines > Air Line Reels	8 - 10
Air Tool Accessories > Air Line Accessories	8, 11
Air Tool Accessories > Air Tool Attachments	11 - 16, 21
Air Tools > Air Drills	24
Air Tools > Air Grinders	24 - 26
Air Tools > Air Hammer	17
Air Tools > Air Impact Wrench	18 - 22
Air Tools > Air Ratchets	22 - 24
Air Tools > Air Sanders	28, 29
Air Tools > Air Saws	29
Air Tools > Other Air Tools	26 - 28, 51
Bit Socket Assortments > 3/8" Socket Tool Set	202
Bit Socket Assortments > Bit Sets	191
Bit Socket Assortments > Bit Sockets	200, 201, 259
Bit Socket Assortments > Hex Bit Assortments	197, 198, 258, 261, 262
Bit Socket Assortments > Mixed Bit Assortments	193, 195, 196, 259 - 262
Bit Socket Assortments > Mixed Bit Sockets	202
Bit Socket Assortments > Ribe Bit Assortments	202, 259
Bit Socket Assortments > Ribe Spline Assortments	202, 259
Bit Socket Assortments > Spline Assortments	199
Bit Socket Assortments > Spline Bit Assortments	199, 200, 262
Bit Socket Assortments > Torx Assortments	194, 261
Bit Socket Assortments > Torx Bit Assortments	191 - 196, 258, 260, 262
Blow Guns and Tyre Inflators > Blow Guns	30, 31
Blow Guns and Tyre Inflators > Tyre Inflators	30
Body and Chassis > Body Work	37 - 44
Body and Chassis > Headlamps and Wind-screens	45
Body and Chassis > Parts Removal	43, 44
Body and Chassis > Pry bars	40
Body and Chassis > Sanding and Polishing	45
Brakes > Brake Bleeding	47 - 51
Brakes > Brake Caliper Rewind	52, 53
Brakes > Brake Pipe and Flaring	45 - 47
Brakes > Disk Brake Spreaders	51
Brakes > Specialist Brake Service	53 - 56, 144
Brakes > Testing and Measuring	56
Breaker Bars > 1/2" Breaker Bars	219
Breaker Bars > 1" Breaker Bars	219
Breaker Bars > 3/4" Breaker Bars	219
Breaker Bars > Breaker Bar Accessories	218
Brushes > Other Brushes	73, 141, 142
Chrome Accessories > Adapters and Reducers	203, 204
Chrome Accessories > Extension Bars	205 - 209
Clothing and Safety > Job Safety	286 - 289
Cordless Tools > Batteries and Chargers	34, 35
Cordless Tools > Battery Series	34
Crowfoot Wrenches > Crowfoot Wrench Set	265

Cutting and Drilling > Burrs	152
Cutting and Drilling > Cutting and Grinding Disks	150 - 152
Cutting and Drilling > Drill Bits and Sets	147 - 149
Cutting and Drilling > Knives	182
Cutting and Drilling > Tap and Die Sets	143 - 147
Diagnostic > Electrical Diagnostics	56 - 60, 293
Diagnostic > Non Electrical Diagnostic	60 - 63, 68
Electrical and Electronic > Charging Systems	64
Electrical and Electronic > Radio and Sat Nav	64
Electrical and Electronic > Terminal Connections	56, 57, 65, 66
Engine Timing Tools > Alfa Romeo Timing Tools	133
Engine Timing Tools > Audi Timing Tools	138
Engine Timing Tools > BMW Mini Timing Tools	137
Engine Timing Tools > BMW Timing Tools	128 - 130
Engine Timing Tools > Citroen Timing Tools	125, 126
Engine Timing Tools > Fiat Timing Tools	139
Engine Timing Tools > Ford Timing Tools	133 - 137
Engine Timing Tools > Land Rover Timing Tools	139
Engine Timing Tools > Mercedes Benz Timing Tools	138, 139
Engine Timing Tools > Renault Timing Tools	127, 128
Engine Timing Tools > Universal Timing Tools	120, 121
Engine Timing Tools > Vauxhall Timing Tools	130 - 133
Engine Timing Tools > Volkswagen Timing Tools	122 - 125
Engine Tools > Cylinder Heads	91, 92
Engine Tools > Engine Valves	88
Engine Tools > Exhaust Tools	86, 87
Engine Tools > Fuel Filters	89 - 91
Engine Tools > Fuel Lines	74, 91
Engine Tools > Fuel Tank and Sender	74, 87
Engine Tools > Glow Plugs	85, 86
Engine Tools > Injectors	69 - 75
Engine Tools > Oil Filters	76, 77, 81 - 84
Engine Tools > Oil Tanks	88, 89
Engine Tools > Radiator and Cooling Systems	66 - 68
Engine Tools > Radiator Testing	66
Engine Tools > Turbo and Charging Systems	87
Engine Tools > Universal Timing Tools	120
Garage Equipment > Battery Boosters	292
Garage Equipment > Booster Cables	293
Garage Equipment > Booster Packs	292
Garage Equipment > Electrical Equipment	296
Garage Equipment > Fluid and Extraction Equipment	78 - 81, 289 - 291
Garage Equipment > Garage Storage	295 - 297
Garage Equipment > Gas Torches and Heating	65, 299
Garage Equipment > Heat Induction	293, 294
Garage Equipment > Service Tools	38
Garage Equipment > Tool Cabinets	298
Hammers > Hammers sets	153
Hammers > Single Hammers	153, 154
Hand Lamps > Head Lamps	308
Hand Lamps > Other Hand Lamps	308, 309

Hand Lamps > Sirius Range	307
Hand Tools > Breaker Bar Accessories	218
Hubs and Bearings > GEN2 Bearings	99 - 101
Hubs and Bearings > GEN3 Bearings	102
Hubs and Bearings > Universal Bearing Kits	95 - 105
Impact Accessories > Impact Adapters and Reducers	210 - 213
Impact Socket Assortments > 1/2" Impact Assortments	215 - 217
Impact Socket Assortments > 1/4" Impact Assortments	217
Impact Socket Assortments > 1" Impact Assortments	217
Impact Socket Assortments > 3/4" Impact Assortments	217
Impact Socket Assortments > 3/8" Impact Assortments	214
Jacking and Lifting > Bottle Jacks	302, 303
Jacking and Lifting > Other Jacks	300
Jacking and Lifting > Transmission Jack Accessories	78, 118, 291, 299
Jacking and Lifting > Transmission Jacks	300, 301
Jacking and Lifting > Trolley Jacks	301, 302
Jacking and Lifting > Workshop Press	305
Measuring > Calipers	155
Oil and Fuel Tanks > Oil Tanks	77
Pliers > Circlip Pliers	166, 167
Pliers > Combination Pliers	173
Pliers > Crimping Pliers	57, 174, 175
Pliers > Cutting Pliers	173, 174
Pliers > Hose Clip and Clamp Pliers	160 - 165
Pliers > Lock Ring Pliers	167 - 169
Pliers > Long Nose Pliers	172, 173
Pliers > Pliers Sets	171
Pliers > Specialist Pliers	156 - 160
Pliers > Water Pump Pliers	170, 171
Power Tools > Battery Series	33
Power Tools > Cordless Impact Wrench	33
Power Tools > Other Cordless Tools	32
Powertrain > Clutch	106 - 108
Presses > Hydraulic Press	97, 303, 304
Presses > Pressing Accessories	303, 304
Pry Bars, Picks and Pick Up Tools > Files	181, 182
Pry Bars, Picks and Pick Up Tools > Pick and Hooks	180, 181
Pry Bars, Picks and Pick Up Tools > Pick Up Tools	178 - 180
Pry Bars, Picks and Pick Up Tools > Pry Bars	175 - 178
Pullers and Installers > Hydraulic and Air Pullers	305
Pullers and Installers > Hydraulic Pullers	105, 303
Pulling Equipment > Manual Pullers	105, 106
Punch and Chisels > Punches	182
Ratchet Repair Kits > Ratchet and Extension Bar	222
Ratchets > 1/2" Single Ratchets	220
Ratchets > Ratchet and Extension Bar	223
Ratchets > Ratchet Repair Kits	222

Ratchets > Ratchet Sets	220, 221
Ratchets > Ratchets	222, 223
Riveters > Riveters and Sets	155
Screwdrivers and Key Sets > Key Sets	183, 187, 188, 189, 193, 261
Screwdrivers and Key Sets > Screwdrivers	183 - 187
Small Parts and Consumables	305
Socket Assortments > 1/2" Assortments	224, 225
Socket Assortments > 1/4" Assortments	223, 224, 228, 229
Socket Assortments > 3/8" Assortments	226, 227
Socket Tools Sets > 1/2" Socket Tool Set	232
Socket Tools Sets > 1/4" Socket Tool Set	231, 235
Socket Tools Sets > 1" Assortments	230, 231
Socket Tools Sets > 1" Socket Tool Set	231
Socket Tools Sets > 3/4" Socket Tool Set	230
Socket Tools Sets > 3/8" Socket Tool Set	234
Socket Tools Sets > Mixed Drive Socket Tool Set	232 - 234
Socket Tools Sets > Mixed Drive Socket Tools Sets	232
Spanner Accessories > Spanner Accessories	265
Spanner Sets > Combination Spanner Sets	268, 269
Spanner Sets > Double Ring Spanner Sets	267, 268
Spanner Sets > Ratchet Spanner Sets	269 - 271
Spanner Sets > Specialist Spanner Sets	121, 266, 267
Specialist Sockets > Drive Shaft Socket	247
Specialist Sockets > Drive Shaft Sockets	247, 248
Specialist Sockets > Extractor Sockets	253 - 256
Specialist Sockets > Oil Filter Sockets	256
Specialist Sockets > Other Specialist Sockets	16, 110, 249 - 253
Specialist Sockets > Spark Plug Sockets	257
Specialist Sockets > Wheel Nut Sockets	236 - 246
Steering and Suspension > Ball Joint Kits	113 - 117
Steering and Suspension > Bushes and Rubbers	93 - 97
Steering and Suspension > CV Joints	23, 117
Steering and Suspension > Drop Arm Pullers	118
Steering and Suspension > Specialist Spanner Sets	117
Steering and Suspension > Spring Compressors	112, 113
Steering and Suspension > Universal Steering and Suspension	16, 108 - 111
Torque Tools > 1/2" Torque Wrench	257, 264
Torque Tools > 3/8" Torque Wrench	264
Wheel and Tyres > Tyre Workshop	23
Workshop Lamps > Hood Lights	309
Workshop Lighting > Emergency Lights	309
Workshop Tools > Hood Lights	309

Code	RRP*	Page
1001-WW	126.60	265
1002-WW	247.79	56
1003-1-WW	90.90	107
1003-WW	64.05	107
1004-WW	69.03	265
1005-1-WW	93.05	65
1005-2-WW	238.39	65
1005-WW	190.94	65
1006-WW	189.98	111
1012-WW	245.92	114
1013-1-WW	160.95	15
1013-1-WW	160.95	101
1013-2-WW	281.16	102
1014-2-WW	84.16	68
1014-WW	69.90	68
1015-1-WW	78.38	142
1015-WW	82.18	142
1016-WW	52.40	119
1017-1-WW	247.20	97
1017-2-WW	101.08	97
1017-WW	150.38	97
1018-1-WW	199.49	78
1018-2-WW	88.16	78
1019-1-WW	24.15	121
1019-WW	139.28	121
1020-23-WW	41.76	112
1020-23-WW	41.76	113
1020-28-WW	41.76	112
1020-28-WW	41.76	113
1020-34-WW	42.90	113
1020-34-WW	42.90	113
1020-WW	85.08	113
1021-WW	96.53	266
1023-WW	122.72	124
1024-WW	97.22	126
1025-WW	103.78	126
10267-WW	23.13	218
1028-WW	67.83	69
1030-WW	83.12	69
1031-WW	135.18	18
1033-1-WW	528.12	98
1033-WW	358.28	98
1034-1-WW	238.95	44
1034-2-WW	88.23	45
1035-1-WW	228.36	106
1035-2-WW	331.73	106
1035-WW	196.69	106
1038-WW	198.43	40
1039-WW	228.75	99
1040-WW	178.91	36
1042-WW	95.46	92
1043-WW	46.05	174
1044-WW	46.05	174

1046-1-WW	8.55	175
1046-2-WW	12.45	175
1046-3-WW	17.34	175
1046-4-WW	19.35	175
1046-WW	59.60	175
1047-WW	138.24	69
1048-WW	48.60	155
1050-WW	78.85	243
1051-WW	62.03	155
1052-WW	277.19	112
1054-WW	86.10	27
1054-WW	86.10	50
1055-WW	19.50	190
1056-WW	73.38	183
1059-WW	242.66	127
1060-WW	91.44	120
1060-WW	91.44	265
1063-10-WW	5.91	276
1063-11-WW	6.24	276
1063-12-WW	6.24	276
1063-13-WW	6.81	276
1063-14-WW	7.59	276
1063-15-WW	7.59	276
1063-16-WW	8.40	276
1063-17-WW	9.06	276
1063-18-WW	9.84	276
1063-19-WW	10.20	276
1063-1-WW	4.77	276
1063-20-WW	12.36	276
1063-2-WW	4.77	276
1063-3-WW	4.77	276
1063-4-WW	4.77	276
1063-5-WW	5.13	276
1063-6-WW	5.13	276
1063-7-WW	5.25	276
1063-8-WW	5.25	276
1063-9-WW	5.91	276
1063-WW	71.88	224
1064-WW	75.08	246
1065-WW	85.42	120
1065-WW	85.42	265
1066-WW	42.57	155
1069-WW	145.28	84
1070-10-WW	138.50	16
1070-11-WW	28.83	13
1070-12-WW	75.63	13
1070-13-WW	33.90	13
1070-14-WW	77.75	14
1070-15-WW	69.00	14
1070-16-WW	86.86	14
1070-17-WW	80.35	10
1070-3-WW	39.99	12
1070-4-WW	35.13	11
1070-5-WW	39.99	11

1070-6-WW	32.91	11
1070-7-WW	31.83	11
1070-9-WW	30.90	12
1070-CHUCK-WW	31.65	12
1070-WW	248.03	16
1071-WW	80.72	125
1073-WW	225.12	130
1075-WW	94.23	121
1076-WW	86.34	122
1077-WW	77.88	246
1078-WW	53.90	63
1079-WW	149.04	166
1080-17-WW	10.56	278
1080-19-WW	10.56	278
1080-21-WW	10.56	278
1080-WW	33.51	235
1081-WW	48.15	248
1082-WW	74.35	176
1084-1-WW	2.01	202
1084-2-WW	2.01	202
1084-3-WW	3.24	202
1084-4-WW	2.70	202
1084-5-WW	7.38	203
1084-6-WW	6.63	203
1084-WW	27.45	203
1085-WW	58.48	252
1088-WW	95.96	132
1094-10-WW	6.03	279
1094-11-WW	6.45	279
1094-12-WW	6.81	279
1094-13-WW	7.02	279
1094-1-WW	4.56	279
1094-2-WW	4.56	279
1094-3-WW	4.56	279
1094-5-WW	4.98	279
1094-6-WW	4.98	279
1094-7-WW	5.34	279
1094-8-WW	5.34	279
1094-9-WW	5.76	279
1094-WW	38.95	213
1095-10-WW	8.37	278
1095-11-WW	8.88	278
1095-12-WW	9.18	278
1095-13-WW	10.20	278
1095-14-WW	10.86	278
1095-15-WW	13.50	278
1095-16-WW	14.31	278
1095-1-WW	6.87	278
1095-2-WW	6.87	278
1095-3-WW	7.26	278
1095-4-WW	7.26	278
1095-5-WW	7.74	278
1095-6-WW	7.74	278
1095-7-WW	7.74	278

1095-8-WW	8.13	278
1095-9-WW	8.13	278
1095-WW	96.93	214
1097-WW	96.43	92
1098-WW	82.88	142
1099-WW	58.03	155
1100-WW	89.46	266
1106-WW	79.80	252
1108-WW	117.22	113
1109-WW	110.62	136
11101-WW	96.34	219
11105-WW	214.40	229
11106-WW	40.20	218
11108-BUTTON-WW	2.25	221
11109-BUTTON-WW	2.64	221
11110-BUTTON-WW	3.00	221
11114-WW	109.02	221
11115-WW	86.22	219
11116-WW	59.00	220
11117-WW	69.00	220
11118-WW	98.95	219
11119-WW	91.08	222
1111-WW	89.13	22
11120-1-WW	10.62	221
11121-1-WW	12.87	221
11122-1-WW	12.60	221
11126-WW	114.58	220
11127-WW	110.42	220
1112-WW	89.13	22
11131-WW	232.25	229
1113-WW	18.84	42
11142-WW	205.98	92
1114-WW	282.21	111
11166-WW	99.88	190
1116-WW	111.82	69
1117-WW	39.93	159
1120-WW	252.60	291
1121-P3-WW	80.52	291
1121-WW	331.25	291
1122-WW	250.79	291
1123-WW	32.52	41
1124-WW	33.69	156
1125-WW	132.68	85
1126-1-WW	35.88	57
1126-2-WW	40.56	57
1126-3-WW	40.77	57
1126-WW	69.93	55
1128-WW	119.84	117
1130-1-WW	10.41	75
1130-WW	154.96	75
1131-WW	258.15	98
1132-WW	194.81	99
1135-WW	210.42	92
1139-WW	41.91	159

1140-WW	11.76	248
11410-WW	51.88	224
1143-WW	136.34	59
1144-WW	192.20	99
1145-WW	199.28	99
1146-WW	225.59	100
1148-WW	134.14	12
1149-WW	43.08	166
1151-WW	43.90	255
1152-22-WW	13.50	248
1152-WW	78.38	248
1155-WW	125.20	38
1156-WW	86.40	256
1158-10-WW.	0.00	245
1158-11-WW	116.78	245
1158-12-WW	14.82	281
1158-13-WW	14.82	281
1158-14-WW	14.82	281
1158-15-WW	14.82	281
1158-16-WW	15.06	281
1158-17-WW	15.06	281
1158-2-WW	11.49	280
1158-3-WW	11.94	280
1158-4-WW	11.94	280
1158-5-WW	11.94	280
1158-6-WW	12.18	280
1158-7-WW	12.18	280
1158-8-WW	12.18	280
1158-9-WW.	0.00	245
1158-WW	80.00	245
1161-1-WW	38.50	160
1161-WW	30.57	160
1162-WW	25.29	160
1163-WW	32.19	59
1165-1-10-WW	3.90	272
1165-1-11-WW	3.90	272
1165-1-12-WW	3.90	272
1165-1-13-WW	4.65	272
1165-1-14-WW	6.06	272
1165-1-15-WW	7.20	272
1165-1-1-WW	2.76	272
1165-1-2-WW	2.76	272
1165-1-3-WW	2.76	272
1165-1-4-WW	2.76	272
1165-1-5-WW	2.76	272
1165-1-6-WW	2.76	272
1165-1-7-WW	2.76	272
1165-1-8-WW	2.76	272
1165-1-9-WW	3.90	272
1165-1-WW	43.74	190
1165-1-WW	43.74	259
1165-2-10-WW	3.18	272
1165-2-11-WW	4.26	272
1165-2-12-WW	5.70	272

1165-2-1-WW	2.22	272
1165-2-2-WW	2.22	272
1165-2-3-WW	2.22	272
1165-2-4-WW	2.22	272
1165-2-5-WW	2.22	272
1165-2-6-WW	2.22	272
1165-2-7-WW	2.22	272
1165-2-8-WW	3.18	272
1165-2-9-WW	3.18	272
1165-2-WW	30.66	190
1165-2-WW	30.66	259
1165-3-10-WW	2.28	272
1165-3-11-WW	3.36	272
1165-3-12-WW	5.22	272
1165-3-1-WW	2.28	272
1165-3-2-WW	2.28	272
1165-3-3-WW	2.28	272
1165-3-4-WW	2.28	272
1165-3-5-WW	2.28	272
1165-3-6-WW	2.28	272
1165-3-7-WW	2.28	272
1165-3-8-WW	3.36	272
1165-3-9-WW	3.36	272
1165-3-WW	30.00	194
1165-3-WW	30.00	259
1165-4-10-WW	4.44	278
1165-4-11-WW	4.62	278
1165-4-12-WW	4.98	278
1165-4-13-WW	5.52	278
1165-4-1-WW	2.70	280
1165-4-2-WW	2.64	280
1165-4-3-WW	2.64	280
1165-4-4-WW	2.64	280
1165-4-5-WW	2.64	280
1165-4-6-WW	3.06	280
1165-4-7-WW	3.06	280
1165-4-8-WW	3.18	280
1165-4-9-WW	3.36	280
1165-4-WW	36.09	191
1165-4-WW	36.09	259
1165-WW	78.40	191
1165-WW	78.40	257
1168-WW	210.86	103
1169-WW	67.70	79
1170-WW	90.70	137
1172-WW	284.85	36
1173-WW	74.30	133
1174-WW	122.78	129
1175-WW	25.32	57
1176-WW	228.53	73
1176-WW	228.53	86
1177-WW	40.71	44
1178-WW	240.06	93
1179-WW	101.56	79

1180-1-WW	16.68	236
1180-WW	16.02	236
1181-ADPT-1-WW	166.17	96
1181-WW	258.85	94
1182-WW	233.54	46
1183-1-WW	56.38	47
1183-WW	140.16	47
1184-WW	36.30	80
1185-WW	14.55	256
1186-WW	67.60	267
1187-WW	30.36	15
1188-WW	104.66	266
1189-WW	44.98	71
1190-WW	46.18	182
1191-WW	46.18	182
1192-WW	79.13	86
1193-WW	40.08	156
1194-WW	261.42	67
1195-1-WW	158.34	50
1195-WW	68.90	50
1197-WW	210.29	55
1198-WW	214.69	102
1199-WW	228.42	70
1200-WW	94.66	80
1201-WW	75.13	80
1202-WW	52.75	292
1208-WW	302.54	61
1210-WW	62.50	45
1211-WW	129.84	51
1212-WW	35.79	196
1213-WW	33.48	191
1214-WW	40.92	191
1215-WW	337.58	45
1216-WW	92.54	66
1217-WW	24.78	80
1219-WW	17.13	156
1220-WW	44.15	156
1222-WW	382.85	229
1223-WW	344.88	230
1224-WW	138.76	68
1226-WW	18.12	10
1227-WW	99.10	137
1228-WW	44.88	136
1229-WW	99.65	133
1230-WW	81.30	133
1231-WW	105.58	68
1232-WW	114.20	43
1233-10-WW	4.44	276
1233-11-WW	4.44	276
1233-12-WW	4.44	276
1233-13-WW	4.71	276
1233-14-WW	5.13	276
1233-15-WW	5.34	276
1233-1-WW	3.66	276

1233-2-WW	3.66	276
1233-3-WW	3.66	276
1233-4-WW	3.66	276
1233-5-WW	3.84	276
1233-6-WW	3.84	276
1233-7-WW	3.84	276
1233-8-WW	3.99	276
1233-9-WW	3.99	276
1233-WW	45.33	226
1234-10-WW	6.96	276
1234-11-WW	7.23	276
1234-12-WW	7.44	276
1234-1-WW	5.13	276
1234-2-WW	5.13	276
1234-3-WW	5.13	276
1234-4-WW	5.64	276
1234-5-WW	5.64	276
1234-6-WW	5.76	276
1234-7-WW	5.76	276
1234-8-WW	6.24	276
1234-9-WW	6.45	276
1234-WW	57.80	226
1235-WW	30.81	186
1237-WW	158.24	59
1238-1-WW	131.04	13
1238-1-WW	131.04	71
1238-WW	242.51	15
1238-WW	242.51	71
1240-WW	83.50	48
1241-WW	181.56	129
1242-4-WW	13.56	39
1242-5-WW	13.56	39
1242-6-WW	13.56	39
1242-7-WW	13.56	39
1242-8-WW	8.94	39
1242-WW	112.16	39
1244-WW	40.58	42
1245-WW	99.22	45
12500-WW	310.32	103
1250-WW	30.42	103
1251-WW	37.74	103
1252-WW	46.65	103
1253-WW	70.00	103
1254-WW	130.36	103
1255-WW	220.67	103
1256-WW	85.15	102
1322-WW	304.76	236
1323-WW	247.33	236
1324-WW	65.88	170
1330-WW	171.05	76
1400-WW	101.58	162
1402-WW	43.71	175
1407-WW	56.78	30
1408-WW	67.40	30

1409-WW	75.00	30
1410-WW	84.38	30
1605-WW	71.78	152
1641-WW	447.98	38
1650-WW	48.48	181
1820-WW	16.32	187
1821-WW	14.13	187
1822-WW	15.00	187
1823-WW	15.51	187
1824-WW	17.70	186
1825-WW	17.31	188
1900-DIEHOLDER-LARGE-WW	12.60	144
1900-DIEHOLDERS-MALL-WW	4.65	144
1900-TAPHOLDER-LARGE-WW	17.25	144
1900-TAPHOLDERS-MALL-WW	5.16	144
1900-WW	162.76	145
1901-WW	158.84	145
1902-WW	121.24	145
1903-WW	42.70	249
1904-WW	138.62	144
1905-WW	53.43	145
1906-WW	44.61	143
2001-WW	112.40	169
2008-WW	93.45	146
2009-WW	47.93	147
2010-WW	81.42	147
2011-WW	35.37	147
2012-WW	158.34	147
2013-WW	102.08	148
2014-WW	52.55	148
2020-1-WW	81.10	33
2020-2-WW	36.39	33
2020-WW	397.50	32
2110-WW	86.98	132
2111-WW	92.66	133
2113-WW	190.05	97
2114-WW	225.20	18
2115-WW	87.92	23
2116-WW	271.01	32
2117-WW	174.99	33
2118-WW	95.30	34
2119-WW	85.42	23
2120-WW	91.05	24
2121-WW	83.14	25
2122-WW	51.90	24
2123-WW	91.15	16
2124-WW	97.35	24
2125-WW	55.20	27
2169-1-WW	765.11	293
2169-2-WW	234.21	293
2169-3-WW	33.03	292

2169-4-WW	234.21	293
2169-WW	765.11	293
2439-WW	13.80	177
2476-WW	270.78	297
2483-WW	34.59	47
2522-WW	15.63	105
2579-WW	0.00	269
2581-WW	0.00	268
2581-WW	0.00	269
267-REPAIR-WW	10.56	217
2885-WW	69.98	235
2886-WW	60.35	194
2887-1-WW	18.60	288
2887-WW	95.55	288
2888-WW	60.40	214
2889-WW	48.60	213
2890-WW	97.78	195
2940-10-WW	21.30	280
2940-11-WW	21.30	280
2940-1-WW	18.90	280
2940-2-WW	18.90	280
2940-3-WW	19.41	280
2940-4-WW	14.55	280
2940-5-WW	19.41	280
2940-6-WW	19.80	280
2940-7-WW	19.80	280
2940-8-WW	19.80	280
2940-9-WW	21.30	280
2940-WW	150.00	240
3000-1-WW	269.79	18
3000-WW	269.79	17
3001-WW	93.45	27
3002-WW	87.22	28
3004-WW	110.02	28
3006-WW	87.48	26
3007-WW	71.03	26
3008-WW	65.15	26
3009-WW	113.64	23
3010-WW	92.00	28
3011-WW	113.24	28
3012-WW	60.58	21
3013-WW	60.58	21
3014-WW	82.48	24
3015-1-WW	2.88	149
3015-2-WW	2.31	149
3015-WW	98.90	25
3016-WW	81.84	25
3018-WW	88.63	21
3019-WW	88.63	21
3020-1-WW	75.00	151
3020-WW	173.44	25
30890-WW	5.07	177
30892-WW	11.94	294
30893-WW	4.71	177

30894-WW	5.22	294
30895-WW	13.77	294
30896-WW	28.86	108
30897-WW	24.75	294
30898-WW	9.06	295
3100-WW	125.00	77
3100-WW	125.00	290
3101-17-WW	16.86	237
3101-19-WW	16.86	237
3101-21-WW	16.86	237
3101-WW	40.73	237
3102-WW	37.63	168
3114-1-WW	195.03	20
3114-2-WW	28.74	20
3114-WW	195.03	20
3115-WW	156.55	19
3116-1-WW	264.06	19
3116-WW	264.06	19
3117-WW	235.56	18
3118-WW	167.85	20
3119-WW	202.35	23
3120-WW	155.07	19
3200-WW	100.00	117
3300-WW	101.20	303
3400-WW	105.00	109
35100-WW	18.57	287
35101-WW	18.57	287
35102-WW	15.36	287
4000-WW	324.87	60
40016-1-WW	50.30	303
40017-WW	160.71	303
4001-WW	40.10	161
4002-WW	38.73	46
4003-1-WW	122.66	60
4003-WW	387.47	60
4004-WW	14.73	249
4005-WW	27.15	160
40063-WW	242.04	137
4006-WW	108.48	240
4007-WW	96.72	240
4008-WW	42.36	74
4009-WW	176.68	120
4010-WW	111.74	288
4011-WW	34.83	134
4012-WW	31.32	128
4013-WW	45.70	289
4014-WW	320.93	87
4015-WW	254.46	134
4016-WW	15.27	249
4017-1-WW	92.84	53
4017-2-WW	42.20	53
4017-3-WW	42.20	53
4017-WW	92.84	53
4018-WW	47.10	243

4019-WW	59.63	240
4020-WW	54.58	241
4021-WW	416.46	32
4022-WW	31.02	188
4023-WW	39.03	188
4024-WW	37.26	188
4025-WW	195.99	122
4026-1-WW	95.82	48
4026-WW	95.82	48
4027-WW	27.39	55
4028-WW	51.93	157
4029-20-WW	15.30	282
4029-21-WW	15.30	282
4029-22-WW	15.30	282
4029-23-WW	18.51	282
4029-24-WW	18.51	282
4029-25-WW	18.51	282
4029-26-WW	21.75	282
4029-27-WW	21.75	282
4029-28-WW	21.75	282
4029-30-WW	25.05	282
4029-32-WW	25.05	282
4029-WW	106.92	264
4030-WW	42.80	9
4031-WW	81.63	9
4033-WW	512.43	95
4034-WW	138.76	241
4035-10-WW	3.78	277
4035-11-WW	3.93	277
4035-12-WW	4.17	277
4035-4-WW	3.15	277
4035-5.5-WW	3.15	277
4035-5-WW	3.15	277
4035-6-WW	3.15	277
4035-7-WW	3.27	277
4035-8-WW	2.31	277
4035-9-WW	3.48	277
4035-WW	35.97	227
4036-10-WW	1.86	277
4036-11-WW	1.86	277
4036-12-WW	1.98	277
4036-13-WW	2.25	277
4036-4-WW	1.74	277
4036-5.5-WW	1.74	277
4036-5-WW	1.74	277
4036-6-WW	1.74	277
4036-7-WW	1.74	277
4036-8-WW	1.74	277
4036-9-WW	1.74	277
4036-WW	23.16	227
4038-WW	438.44	298
4039-WW	526.56	298
4040-WW	89.08	66
4041-H10-WW	3.90	272

4041-H12-WW	4.59	272
4041-H14-WW	5.04	272
4041-H15-WW	6.51	272
4041-H17-WW	7.14	272
4041-H19-WW	8.76	272
4041-H2.5-WW	2.31	272
4041-H22-WW	11.19	272
4041-H2-WW	2.31	272
4041-H3-WW	2.31	272
4041-H4-WW	2.31	272
4041-H5.5-WW	2.31	272
4041-H5-WW	2.31	272
4041-H6-WW	2.31	272
4041-H7-WW	3.60	272
4041-H8-WW	3.60	272
4041-H9-WW	3.90	272
4041-WW	48.85	192
4041-WW	48.85	258
4042-WW	182.97	9
4043-WW	25.38	209
4044-WW	41.35	161
4045-WW	132.34	252
4047-WW	136.84	116
4048-WW	148.52	114
4049-WW	131.60	101
4050-WW	46.30	116
4051-WW	59.80	107
4052-WW	21.06	29
4053-WW	38.25	58
4054-M10-WW	3.90	272
4054-M12-WW	5.25	272
4054-M13-WW	5.16	272
4054-M14-WW	5.16	272
4054-M16-WW	7.65	272
4054-M18-WW	8.94	272
4054-M4-WW	2.40	273
4054-M5-WW	2.40	273
4054-M6-WW	2.40	273
4054-M7-WW	3.66	273
4054-M8-WW	3.66	273
4054-M9-WW	3.90	273
4054-WW	47.80	199
4054-WW	47.80	258
4055-WW	294.23	299
4056-WW	194.25	300
4057-WW	48.35	183
4058-WW	87.78	204
4060-WW	55.00	246
4061-WW	36.84	39
4062-WW	92.48	119
4063-1-WW	87.50	241
4063-WW	155.42	241
4064-WW	53.13	286
4067-WW	41.16	81

4068-T30-WW	8.22	273
4068-T40-WW	8.22	273
4068-T45-WW	8.40	273
4068-T50-WW	8.40	273
4068-T55-WW	9.66	273
4068-T60-WW	9.66	273
4068-T70-WW	11.16	273
4068-T80-WW	13.41	273
4068-WW	70.33	193
4069-WW	269.82	84
4070-M10-WW	8.40	273
4070-M12-WW	9.66	273
4070-M14-WW	9.66	273
4070-M16-WW	11.16	273
4070-M18-WW	13.41	273
4070-M5-WW	8.22	273
4070-M6-WW	8.22	273
4070-M8-WW	8.40	273
4070-WW	70.33	198
4071-H10-WW	7.41	273
4071-H12-WW	8.52	273
4071-H14-WW	8.52	273
4071-H17-WW	9.84	273
4071-H19-WW	11.82	273
4071-H5-WW	7.26	273
4071-H6-WW	7.26	273
4071-H8-WW	7.41	273
4071-WW	65.58	196
4072-WW	53.00	176
4073-WW	152.56	176
4074-WW	61.98	122
4075-WW	228.55	128
4076-WW	73.55	134
4077-WW	108.76	132
4078-WW	249.15	138
4080-WW	59.33	14
4081-WW	92.05	161
4082-WW	133.20	122
4083-WW	95.34	49
4084-WW	50.00	89
4085-WW	130.06	148
4086-WW	154.16	101
4087-WW	37.50	89
4088-WW	37.50	89
4089-WW	37.50	89
4090-10-WW	10.11	280
4090-11-WW	10.11	280
4090-12-WW	10.11	280
4090-13-WW	10.11	280
4090-14-WW	10.11	280
4090-15-WW	10.11	280
4090-16-WW	11.79	280
4090-17-WW	11.79	280
4090-19-WW	11.79	280

4090-WW	56.35	253
4091-WW	115.00	108
4092-WW	167.46	93
4093-WW	106.24	15
4093-WW	106.24	249
4094-WW	145.84	109
4095-WW	41.98	157
4096-WW	80.50	146
4097-WW	46.68	162
4098-WW	44.70	148
4099-WW	75.38	59
4099-WW	75.38	292
4101-WW	11.34	256
4102-WW	258.78	104
4102-WW	258.78	302
4103-1-WW	28.44	110
4103-2-WW	29.19	110
4104-WW	67.73	230
4105-WW	86.65	52
4106-1-WW	93.32	61
4106-1-WW	93.32	70
4106-WW	93.00	61
4106-WW	93.00	70
4107-H19-WW	11.97	273
4108-WW	63.45	38
4110-WW	85.98	100
4111-WW	31.05	165
4112-WW	30.99	165
4113-WW	44.70	165
4114-WW	65.10	165
4115-WW	41.93	166
4116-WW	31.80	166
4113-WW	91.58	253
4114-WW	91.06	84
4116-10-WW	9.84	210
4116-11-WW	12.09	210
4116-12-WW	15.96	210
4116-1-WW	56.55	209
4116-2-WW	1.80	210
4116-3-WW	1.86	211
4116-4-WW	2.31	211
4116-5-WW	3.45	211
4116-6-WW	6.36	211
4116-7-WW	10.62	212
4116-8-WW	13.26	212
4116-9-WW	16.86	212
4116-WW	40.65	212
4117-WW	224.35	104
4118-WW	24.36	37
4119-17-WW	6.72	278
4119-19-WW	7.41	278
4119-21-WW	8.22	278
4119-24-WW	10.53	278
4119-32-WW	16.44	278

4119-WW	77.15	214
4120-WW	153.18	42
4121-WW	174.16	84
4121-WW	174.16	250
4122-WW	84.40	242
4123-WW	93.38	37
4128-WW	69.48	37
4130-WW	23.28	250
4131-WW	83.53	40
4132-WW	69.80	88
4133-WW	83.75	94
4134-WW	28.98	37
4135-WW	76.28	253
4136-WW	125.20	26
4137-WW	81.90	231
4139-WW	186.81	43
4140-WW	153.22	200
4141-10-WW	0.00	276
4141-11-WW	0.00	276
4141-12-WW	0.00	276
4141-13-WW	0.00	276
4141-14-WW	0.00	276
4141-15-WW	0.00	276
4141-16-WW	0.00	276
4141-17-WW	0.00	276
4141-18-WW	0.00	276
4141-19-WW	0.00	276
4141-20-WW	0.00	276
4141-21-WW	0.00	276
4141-22-WW	0.00	276
4141-24-WW	0.00	276
4141-27-WW	0.00	276
4141-30-WW	0.00	276
4141-32-WW	0.00	276
4141-WW	38.67	225
4142-WW	42.53	225
4143-10-WW	0.00	277
4143-11-WW	0.00	277
4143-12-WW	0.00	277
4143-13-WW	0.00	277
4143-14-WW	0.00	277
4143-4.5-WW	0.00	277
4143-4-WW	0.00	277
4143-5.5-WW	0.00	277
4143-5-WW	0.00	277
4143-6-WW	0.00	277
4143-7-WW	0.00	277
4143-8-WW	0.00	277
4143-9-WW	0.00	277
4143-WW	18.78	228
4144-10-WW	0.00	278
4144-11-WW	0.00	278
4144-12-WW	0.00	278
4144-13-WW	0.00	278

4144-14-WW	0.00	278
4144-4.5-WW	0.00	278
4144-4-WW	0.00	278
4144-5.5-WW	0.00	278
4144-5-WW	0.00	278
4144-6-WW	0.00	278
4144-7-WW	0.00	278
4144-8-WW	0.00	278
4144-9-WW	0.00	278
4144-WW	29.55	228
4145-10-WW	0.00	277
4145-11-WW	0.00	277
4145-12-WW	0.00	277
4145-13-WW	0.00	277
4145-14-WW	0.00	277
4145-15-WW	0.00	277
4145-16-WW	0.00	277
4145-17-WW	0.00	277
4145-18-WW	0.00	277
4145-19-WW	0.00	277
4145-20-WW	0.00	277
4145-21-WW	0.00	277
4145-22-WW	0.00	277
4145-23-WW	0.00	277
4145-24-WW	0.00	277
4145-8-WW	0.00	277
4145-9-WW	0.00	277
4145-WW	32.76	226
4146-10-WW	0.00	277
4146-11-WW	0.00	277
4146-12-WW	0.00	277
4146-13-WW	0.00	277
4146-14-WW	0.00	277
4146-15-WW	0.00	277
4146-16-WW	0.00	277
4146-17-WW	0.00	277
4146-18-WW	0.00	277
4146-19-WW	0.00	277
4146-20-WW	0.00	277
4146-21-WW	0.00	277
4146-8-WW	0.00	277
4146-9-WW	0.00	277
4146-WW	39.57	226
4147-WW	55.10	216
4148-WW	84.00	304
4149-WW	219.69	93
4150-WW	173.84	231
4151-WW	72.48	253
4155-WW	39.18	130
4156-WW	105.04	126
4157-WW	48.50	127
4158-WW	84.88	136
4159-WW	15.27	127
4160-WW	95.03	138

4161-WW	83.40	128
4162-10-WW	7.62	278
4162-11-WW	7.62	278
4162-12-WW	7.62	278
4162-13-WW	7.74	278
4162-14-WW	7.74	278
4162-15-WW	7.74	278
4162-16-WW	6.39	278
4162-18-WW	8.82	278
4162-22-WW	9.00	278
4162-27-WW	11.64	278
4162-30-WW	1.62	278
4162-WW	77.10	214
4163-WW	72.75	130
4164-WW	63.78	130
4165-WW	42.20	192
4167-M10-WW	5.94	273
4167-M12-WW	5.94	273
4167-M14-WW	5.94	273
4167-M16-WW	10.47	273
4167-M18-WW	10.68	273
4167-M4-WW	4.14	273
4167-M5-WW	4.14	273
4167-M6-WW	4.14	273
4167-M8-WW	4.14	273
4167-WW	39.98	198
4168-T10-WW	4.14	273
4168-T15-WW	4.14	273
4168-T20-WW	4.14	273
4168-T25-WW	4.14	273
4168-T27-WW	4.14	273
4168-T30-WW	4.14	273
4168-T40-WW	5.94	273
4168-T45-WW	5.94	273
4168-T47-WW	5.94	273
4168-T50-WW	5.94	273
4168-WW	44.31	193
4169-WW	38.95	197
4170-WW	58.10	167
4171-WW	91.85	134
4172-WW	48.70	230
4173-WW	42.75	225
4174-WW	46.08	225
4175-WW	17.88	228
4176-WW	23.34	228
4177-WW	28.86	227
4178-WW	34.35	227
4179-WW	32.73	123
4180-WW	72.40	58
4182-1-WW	0.00	49
4182-2-WW	0.00	49
4182-WW	85.10	49
4183-WW	98.00	246
4184-WW	23.28	247

4185-1-WW	148.96	242
4185-2-WW	138.76	242
4186-WW	86.70	242
4187-WW	77.50	234
4188-WW	162.39	231
4189-WW	150.35	232
4190-WW	16.86	250
4191-WW	29.04	87
4192-WW	125.24	22
4192-WW	125.24	116
4193-WW	55.38	51
4194-WW	82.04	116
4196-WW	118.96	115
4197-WW	89.63	250
4198-WW	55.05	55
4199-WW	148.62	70
4201-WW	123.28	105
4202-WW	132.34	123
4203-WW	110.72	103
4204-WW	102.16	233
4206-WW	90.53	218
4207-1-WW	33.93	217
4207-WW	86.20	218
4208-WW	62.25	87
4209-WW	31.59	247
4210-WW	42.84	247
4211-WW	23.55	247
4212-1-WW	34.83	105
4212-WW	139.58	105
4213-WW	37.20	161
4216-10-WW	9.90	282
4216-11-WW	9.90	282
4216-12-WW	9.90	282
4216-13-WW	10.56	282
4216-14-WW	10.56	282
4216-15-WW	10.56	282
4216-16-WW	11.31	282
4216-17-WW	11.31	282
4216-18-WW	12.00	282
4216-19-WW	12.00	282
4216-WW	52.70	264
4217-WW	80.00	135
4218-WW	42.84	201
4219-WW	122.08	66
4301-WW	24.75	29
5000-WW	21.36	88
5001-WW	228.20	41
5002-WW	86.18	137
5003-WW	32.34	178
5004-WW	161.49	244
5005-WW	47.93	157
5006-WW	122.28	131
5007-WW	98.95	168
5008-WW	266.39	46

5009-WW	98.80	81
500-WW	22.50	178
5010-WW	51.95	64
5011-WW	74.85	40
5012-WW	76.90	183
5013-WW	45.53	157
5014-WW	41.30	162
5015-WW	136.32	195
5015-WW	136.32	260
5016-WW	47.30	182
5017-WW	46.43	182
5018-WW	31.74	87
5019-WW	42.75	183
501-WW	4.68	178
5020-WW	97.85	115
5021-1-WW	71.45	34
5021-2-WW	0.00	34
5021-WW	151.00	31
5022-WW	110.86	216
5024-WW	38.52	81
5025-WW	38.52	81
51001-WW	97.18	146
51002-WW	29.97	158
51003-WW	180.84	115
51004-WW	150.42	128
51005-WW	158.25	120
51006-WW	468.63	129
51007-WW	139.96	125
51008-WW	50.55	135
51009-WW	172.61	123
5180-10-200-WW	7.86	273
5180-M10-100-WW	4.95	273
5180-M10-140-WW	5.94	273
5180-M10-55-WW	3.93	273
5180-M12-100-WW	5.49	273
5180-M12-140-WW	6.75	273
5180-M12-200-WW	8.43	273
5180-M12-55-WW	4.26	273
5180-M14-100-WW	6.63	273
5180-M14-140-WW	8.07	273
5180-M14-200-WW	10.56	273
5180-M14-55-WW	5.07	273
5180-M16-55-WW	6.63	273
5180-M5-100-WW	4.95	273
5180-M5-140-WW	5.94	273
5180-M5-55-WW	3.93	274
5180-M6-100-WW	4.95	274
5180-M6-140-WW	5.94	274
5180-M6-55-WW	3.93	274
5180-M8-100-WW	4.95	274
5180-M8-140-WW	5.94	274
5180-M8-200-WW	7.86	274
5180-M8-55-WW	3.93	274
5180-M9-100-WW	4.95	274

5180-M9-140-WW	5.94	274
5180-M9-55-WW	3.93	274
5180-WW	88.34	198
5181-WW	91.04	196
5182-T20-100-WW	4.53	274
5182-T20-55-WW	3.63	274
5182-T25-100-WW	4.53	274
5182-T25-55-WW	3.63	274
5182-T27-100-WW	4.53	274
5182-T27-55-WW	3.63	274
5182-T30-100-WW	4.53	274
5182-T30-55-WW	3.63	274
5182-T40-100-WW	4.53	274
5182-T40-140-WW	5.46	274
5182-T40-200-WW	7.26	274
5182-T40-55-WW	3.63	274
5182-T45-100-WW	4.53	274
5182-T45-140-WW	5.46	274
5182-T45-200-WW	7.26	274
5182-T45-55-WW	3.63	274
5182-T50-100-WW	4.53	274
5182-T50-140-WW	5.46	274
5182-T50-200-WW	7.26	274
5182-T50-55-WW	3.63	274
5182-T55-100-WW	4.53	274
5182-T55-140-WW	5.46	274
5182-T55-200-WW	7.26	274
5182-T55-55-WW	3.63	274
5182-T60-100-WW	5.07	274
5182-T60-140-WW	6.21	274
5182-T60-200-WW	7.77	274
5182-T60-55-WW	3.90	274
5182-T70-100-WW	6.09	274
5182-T70-140-WW	7.41	274
5182-T70-200-WW	9.72	274
5182-T70-55-WW	4.65	274
5182-WW	94.88	194
5189-WW	20.34	197
557-WW	36.87	10
558-WW	34.14	170
559-WW	30.00	10
600021-WW	61.55	162
600022-WW	73.50	163
600023-WW	67.88	74
600027-WW	35.04	82
60005-WW	41.68	7
60006-WW	19.05	7
60008-WW	41.93	7
60009-WW	166.11	8
60010-WW	76.20	7
60011-WW	159.56	8
60012-WW	189.70	8
60013-1-WW	9.39	72
60013-WW	120.76	72

60025-WW	21.00	82
60026-WW	36.63	88
60028-WW	51.00	251
60029-WW	41.49	90
60030-WW	250.13	100
60031-WW	98.34	51
60032-WW	50.98	7
60033-WW	207.42	58
60035-10-WW	11.31	281
60035-12-WW	12.36	281
60035-13-WW	13.95	281
60035-14-WW	15.60	281
60035-17-WW	18.39	281
60035-19-WW	20.25	281
60035-8-WW	10.95	281
60035-WW	84.50	268
60036-WW	155.84	125
60038-WW	152.48	106
60039-WW	253.58	16
60040-WW	15.51	119
60041-WW	147.66	56
60042-WW	128.34	48
60043-WW	23.58	256
60044-WW	49.13	82
60045-WW	122.86	56
60045-WW	122.86	173
60046-WW	26.73	114
60048-WW	117.50	94
60049-WW	39.66	296
60050-WW	26.94	179
60051-WW	36.36	39
60052-WW	28.14	168
60053-WW	83.84	56
60053-WW	83.84	173
60054-WW	91.62	58
60055-WW	72.05	292
60056-WW	96.50	63
60057-17-WW	28.14	239
60057-19-WW	28.14	239
60057-21-WW	28.14	239
60057-WW	79.05	239
60058-WW	39.39	50
60059-WW	149.74	232
60063-WW	26.31	251
60065-17-WW	22.80	280
60065-19-WW	24.06	280
60065-21-WW	24.69	280
60065-22-WW	27.81	280
60065-WW	80.05	254
60066-WW	36.87	154
60067-WW	13.44	180
60068-WW	13.23	163
60069-WW	309.38	300
60070-10-WW	6.72	278

60070-11-WW	7.02	278
60070-12-WW	7.02	278
60070-13-WW	7.14	278
60070-14-WW	7.14	278
60070-15-WW	7.14	278
60070-16-WW	7.14	278
60070-17-WW	7.26	278
60070-18-WW	8.10	278
60070-19-WW	8.10	278
60070-21-WW	8.10	278
60070-22-WW	8.28	278
60070-24-WW	8.85	278
60070-27-WW	10.68	279
60070-30-WW	12.99	279
60070-33-WW	14.16	279
60070-34-WW	19.02	279
60070-36-WW	19.56	279
60070-38-WW	24.21	279
60070-WW	87.08	215
60072-WW	218.15	78
60072-WW	218.15	289
60073-WW	389.07	78
60073-WW	389.07	289
60074-WW	164.13	85
60075-WW	201.34	129
60076-WW	193.95	244
60077-17-WW	31.68	238
60077-19-WW	31.68	238
60077-21-WW	31.68	238
60077-WW	80.08	238
60078-WW	30.81	86
60079-WW	26.13	251
60080-WW	21.06	65
60084-WW	94.95	222
6017-WW	90.00	269
60910-WW	186.15	302
60911-WW	240.69	302
6100-WW	228.75	51
6105-WW	97.36	223
6106-WW	63.98	223
6107-WW	62.78	223
6108-WW	89.70	223
6110-WW	12.24	204
6111-WW	29.13	204
6112-WW	35.67	204
6113-WW	43.17	205
6114-WW	33.06	206
6115-WW	45.28	206
6116-WW	23.43	203
6117-WW	41.15	205
6118-WW	61.73	205
6119-WW	0.00	206
6120-WW	0.00	206
6121-WW	0.00	207

6123-WW	0.00	207
6124-WW	0.00	207
6125-WW	0.00	207
6126-WW	0.00	208
6127-WW	0.00	208
6128-WW	0.00	208
67305-1-WW	72.55	95
67305-M10-WW	20.28	95
67305-M12-WW	22.11	95
67305-M14-WW	23.16	95
67305-M16-WW	25.32	95
67305-M18-WW	24.00	95
67305-WW	213.01	94
67306-A1-WW	159.40	96
67306-A2-WW	86.13	96
67306-WW	262.59	96
67307-1-WW	126.04	73
67307-WW	129.56	73
6880-WW	55.13	200
6881-WW	33.75	200
6882-WW	58.33	199
7001-10-WW	17.49	279
7001-12-WW	17.49	279
7001-13-WW	17.49	279
7001-14-WW	17.49	279
7001-15-WW	17.61	279
7001-17-WW	17.94	279
7001-18-WW	18.30	279
7001-19-WW	19.50	279
7001-21-WW	20.19	279
7001-22-WW	20.46	279
7001-24-WW	22.05	279
7001-27-WW	26.16	279
7001-30-WW	32.46	279
7001-32-WW	36.24	279
7001-WW	145.84	215
7003-WW	136.08	93
7007-WW	18.24	286
7009-WW	90.50	163
7010-WW	198.56	117
7011-WW	25.95	110
7012-WW	43.29	285
7013-WW	393.30	27
7017-WW	536.51	61
7018-WW	68.05	110
7019-WW	26.31	163
701-WW	81.40	71
701-WW	81.40	90
7020-WW	88.03	254
7021-WW	39.30	285
7023-1-WW	34.38	195
7023-1-WW	34.38	261
7023-2-WW	39.99	197
7023-2-WW	39.99	261

7023-3-WW	44.37	197
7023-3-WW	44.37	261
7023-4-WW	39.18	199
7023-4-WW	39.18	261
7023-H10-WW	5.76	274
7023-H3-WW	5.43	274
7023-H4-WW	5.43	274
7023-H5-WW	5.76	274
7023-H6-WW	5.76	274
7023-H7-WW	5.76	274
7023-H8-WW	5.76	274
7023-H9-WW	5.76	274
7023-M10-WW	6.63	274
7023-M4-WW	5.25	274
7023-M5-WW	5.25	274
7023-M6-WW	5.25	274
7023-M7-WW	5.25	274
7023-M8-WW	5.25	274
7023-M9-WW	6.63	274
7023-T20-WW	5.43	274
7023-T25-WW	5.43	274
7023-T27-WW	5.43	274
7023-T30-WW	5.43	274
7023-T40-WW	5.43	274
7023-T45-WW	5.43	274
7023-WW	82.88	194
7023-WW	82.88	261
7024-10-WW	3.96	279
7024-11-WW	3.96	279
7024-12-WW	3.96	279
7024-13-WW	3.96	279
7024-14-WW	3.96	279
7024-15-WW	3.96	279
7024-16-WW	3.96	279
7024-17-WW	3.96	279
7024-18-WW	3.96	279
7024-19-WW	5.88	279
7024-21-WW	7.98	279
7024-22-WW	8.10	279
7024-24-WW	8.85	279
7024-27-WW	8.85	279
7024-30-WW	12.18	279
7024-32-WW	12.18	279
7024-WW	81.98	215
7025-WW	36.51	119
7026-WW	225.55	107
7027-1-WW	9.63	153
7027-2-WW	11.55	153
7027-3-WW	15.36	153
7027-4-WW	31.74	153
7027-WW	61.45	152
7028-WW	258.85	138
7029-WW	14.67	123
702-WW	231.90	73

702-WW	231.90	90
7030-T10-WW	4.26	275
7030-T15-WW	4.26	275
7030-T20-WW	4.26	275
7030-T25-WW	4.26	275
7030-T27-WW	4.26	275
7030-T30-WW	4.26	275
7030-T40-WW	5.64	275
7030-T45-WW	5.64	275
7030-T47-WW	5.64	275
7030-T50-WW	5.64	275
7030-T55-WW	5.64	275
7030-T60-WW	9.51	275
7030-T6-WW	4.38	275
7030-T70-WW	4.95	275
7030-T8-WW	4.38	275
7030-WW	55.68	192
7030-WW	55.68	257
7031-H10-WW	0.00	275
7031-H12-WW	0.00	275
7031-H14-WW	0.00	275
7031-H15-WW	0.00	275
7031-H17-WW	0.00	275
7031-H19-WW	0.00	275
7031-H2.5-WW	0.00	275
7031-H22-WW	0.00	275
7031-H2-WW	0.00	275
7031-H3-WW	0.00	275
7031-H4-WW	0.00	275
7031-H5.5-WW	0.00	275
7031-H5-WW	0.00	275
7031-H6-WW	0.00	275
7031-H7-WW	0.00	275
7031-H8-WW	0.00	275
7031-H9-WW	0.00	275
7031-WW	94.53	196
7031-WW	94.53	257
7032-M10-WW	0.00	275
7032-M12-WW	0.00	275
7032-M13-WW	0.00	275
7032-M14-WW	0.00	275
7032-M16-WW	0.00	275
7032-M18-WW	0.00	275
7032-M4-WW	0.00	275
7032-M5-WW	0.00	275
7032-M6-WW	0.00	275
7032-M7-WW	0.00	275
7032-M8-WW	0.00	275
7032-M9-WW	0.00	275
7032-WW	68.23	201
7032-WW	68.23	258
7033-WW	49.63	201
7033-WW	49.63	258
7034-WW	113.76	244

7035-1-WW	37.05	34
7035-WW	115.50	31
7036-1-WW	56.63	33
7036-WW	152.90	32
7037-T20-WW	0.00	275
7037-T25-WW	0.00	275
7037-T27-WW	0.00	275
7037-T30-WW	0.00	275
7037-T40-WW	0.00	275
7037-T45-WW	0.00	275
7037-WW	23.64	193
7037-WW	23.64	260
7038-H10-WW	0.00	275
7038-H3-WW	0.00	275
7038-H4-WW	0.00	275
7038-H5-WW	0.00	275
7038-H6-WW	0.00	275
7038-H7-WW	0.00	275
7038-H8-WW	0.00	275
7038-WW	27.06	192
7038-WW	27.06	260
7039-H10-WW	0.00	275
7039-H3-WW	0.00	275
7039-H4-WW	0.00	275
7039-H5-WW	0.00	275
7039-H6-WW	0.00	275
7039-H7-WW	0.00	275
7039-H8-WW	0.00	275
7039-WW	26.49	197
7039-WW	26.49	260
7050-WW	57.13	76
7051-10-WW	8.34	279
7051-11-WW	8.34	279
7051-12-WW	8.34	279
7051-13-WW	8.34	279
7051-14-WW	8.34	279
7051-15-WW	8.34	279
7051-16-WW	8.34	279
7051-17-WW	8.34	279
7051-18-WW	8.94	279
7051-19-WW	8.94	279
7051-21-WW	9.75	279
7051-22-WW	11.46	279
7051-23-WW	12.36	279
7051-24-WW	12.36	279
7051-27-WW	14.46	279
7051-30-WW	17.25	279
7051-32-WW	19.20	279
7051-WW	95.44	215
7052-10-WW	5.64	280
7052-11-WW	5.64	280
7052-12-WW	5.64	280
7052-13-WW	6.81	280
7052-14-WW	6.81	280

7052-15-WW	7.59	280
7052-16-WW	7.59	280
7052-17-WW	8.94	280
7052-18-WW	9.45	280
7052-19-WW	9.45	280
7052-21-WW	10.20	280
7052-22-WW	11.31	280
7052-8-WW	5.64	280
7052-9-WW	5.64	280
7052-WW	77.63	216
7053-WW	29.61	295
7054-WW	66.68	66
7056-WW	88.65	285
7057-WW	107.70	154
7058-WW	40.63	154
7059-WW	32.82	154
7060-WW	221.20	232
7061-WW	145.24	233
7062-WW	216.30	289
7063-WW	141.68	233
7064-WW	30.18	209
7065-WW	32.19	184
7067-WW	18.93	200
7068-WW	69.70	299
7070-WW	81.13	251
7071-WW	40.45	82
7072-WW	28.74	141
7077-WW	15.99	164
7080-WW	149.50	138
7081-WW	186.57	299
7082-WW	115.62	299
7087-WW	112.30	85
7089-WW	107.72	121
71001-WW	27.09	77
71001-WW	27.09	290
71002-WW	32.73	77
71002-WW	32.73	290
720-WW	0.00	219
7450-WW	76.70	264
7451-WW	40.93	264
7452-WW	68.75	29
7453-10-WW	16.68	280
7453-12-WW	17.25	280
7453-3-WW	11.31	280
7453-4-WW	11.31	280
7453-5-WW	11.31	280
7453-6-WW	11.31	280
7453-7-WW	12.12	280
7453-8-WW	10.71	280
7453-WW	78.13	254
78091-WW	83.34	151
78092-WW	99.66	151
78093-WW	228.70	95
780-WW	12.87	158

78100-WW	30.33	54
78101-WW	262.85	54
781-WW	47.33	171
783-WW	67.00	307
785-WW	69.70	307
786-WW	64.08	306
787-WW	64.08	306
788-WW	64.45	306
78904-WW	28.38	181
78905-WW	242.57	300
78906-WW	38.07	176
78907-WW	28.71	41
78908-WW	15.18	184
78909-WW	41.50	41
78910-WW	170.98	104
78911-WW	80.18	301
78912-WW	250.45	301
789-WW	12.93	178
790-WW	57.75	306
791-WW	57.75	306
792-WW	57.75	306
793-WW	77.60	307
794-WW	65.43	307
799-WW	18.54	63
800002-UTC	201.61	100
800003-UTC	53.95	169
800004-1-UTC	0.00	60
800004-UTC	94.50	62
800005-UTC	67.63	62
800005-UTC	67.63	67
800006-UTC	31.02	43
800007-UTC	108.52	85
800008-UTC	58.43	146
800010-UTC	56.98	135
800011-UTC	167.85	131
800013-UTC	70.03	113
800017-UTC	159.30	301
800018-UTC	38.76	171
800020-UTC	59.25	171
800021-UTC	31.65	184
800022-UTC	40.88	184
800023-UTC	123.78	269
800026-UTC	42.00	181
800027-UTC	89.16	267
800031-UTC	69.25	124
800033-UTC	39.54	168
800034-UTC	31.50	173
800035-UTC	232.30	124
800036-UTC	83.00	62
800037-UTC	99.95	105
800038-UTC	166.33	111
800039-UTC	93.75	63
800040-UTC	25.32	164
800041-UTC	87.70	104

800042-UTC	38.00	164
800043-UTC	26.70	164
800044-UTC	46.13	72
800044-UTC	46.13	140
800050-UTC	35.85	254
800051-UTC	141.34	43
800053-UTC	80.58	124
800054-UTC	43.92	86
800055-UTC	45.00	88
800060-1-UTC	68.23	67
800060-UTC	148.16	67
800061-UTC	111.54	101
800062-UTC	36.42	177
800063-UTC	44.43	169
800064-UTC	144.66	102
800065-UTC	147.92	229
800066-UTC	134.46	114
800067-UTC	42.09	185
800068-UTC	36.45	171
800069-UTC	44.05	188
800071-UTC	84.23	244
800072-UTC	196.56	198
800073-UTC	296.25	230
800074-UTC	28.68	255
800075-UTC	94.16	46
800076-UTC	13.56	83
800077-UTC	40.73	62
800078-UTC	43.14	115
800080-UTC	33.75	205
800090-UTC	40.50	186
800091-UTC	117.88	175
800092-UTC	37.50	143
800095-UTC	63.03	287
8001-WW	122.46	22
8002-WW	130.50	243
8003-WW	190.96	243
8004-WW	22.50	76
8005-WW	12.12	76
8007-WW	49.68	72
8007-WW	49.68	140
8008-WW	53.95	169
8009-10-WW	10.74	281
8009-11-WW	11.19	281
8009-12-WW	12.09	281
8009-14-WW	15.75	281
8009-15-WW	17.25	281
8009-17-WW	19.86	281
8009-1-WW	6.42	281
8009-20-WW	29.94	281
8009-23-WW	35.34	281
8009-25-WW	38.13	281
8009-2-WW	6.87	281
8009-3-WW	6.63	281
8009-4-WW	6.93	281

8009-5-WW	7.26	281
8009-6-WW	8.16	281
8009-7-WW	8.82	281
8009-8-WW	9.18	281
8009-9-WW	9.96	281
8009-WW	88.40	269
8010-10-WW	15.18	282
8010-11-WW	15.93	282
8010-12-WW	17.04	282
8010-1-WW	9.12	282
8010-2-WW	9.27	282
8010-3-WW	9.39	282
8010-4-WW	9.90	282
8010-5-WW	10.23	282
8010-6-WW	11.58	282
8010-7-WW	12.48	282
8010-8-WW	14.67	282
8010-9-WW	14.58	282
8010-WW	98.58	269
8012-WW	39.21	267
8013-WW	29.19	255
8014-WW	30.54	158
8015-WW	7.14	179
8016-1-WW	46.38	90
8016-WW	95.40	91
8017-10-WW	7.86	282
8017-11-WW	8.49	282
8017-12-WW	8.49	282
8017-1-WW	4.47	282
8017-2-WW	4.83	282
8017-3-WW	4.89	281
8017-4-WW	5.04	281
8017-5-WW	5.67	281
8017-6-WW	6.15	281
8017-7-WW	6.42	281
8017-8-WW	7.05	281
8017-9-WW	7.71	281
8017-WW	90.00	270
8018-WW	31.11	170
8019-6-WW	9.72	109
8019-WW	153.72	108
801-UTC	69.75	29
8020-WW	244.94	95
8022-WW	63.35	158
8023-WW	59.05	47
8024-WW	94.24	98
8025-WW	37.50	185
8026-WW	271.29	304
8028-WW	104.16	52
802-UTC	35.58	255
8030-WW	20.31	298
8031-10-WW	5.28	282
8031-11-WW	5.91	282
8031-12-WW	5.91	282

8031-16-WW	6.60	282
8031-17-WW	7.71	282
8031-18-WW	8.55	282
8031-19-WW	9.51	282
8031-1-WW	2.85	282
8031-20-WW	10.74	282
8031-21-WW	11.76	282
8031-22-WW	12.90	282
8031-23-WW	13.89	282
8031-24-WW	14.70	282
8031-25-WW	15.75	282
8031-2-WW	3.00	282
8031-3-WW	3.30	282
8031-4-WW	3.60	282
8031-5-WW	3.96	282
8031-6-WW	4.29	282
8031-7-WW	4.65	282
8031-8-WW	5.04	282
8031-9-WW	5.16	282
8031-WW	48.13	268
8032-WW	109.42	268
8033-WW	18.69	38
8034-WW	12.24	40
8035-WW	30.00	195
8036-WW	151.52	216
804-UTC	13.65	179
8050-WW	122.66	252
8051-WW	149.30	135
8052-WW	209.20	131
8053-WW	195.03	131
8054-WW	205.66	127
8055-WW	149.50	132
8056-WW	198.56	136
8057-WW	231.26	263
8058-WW	243.75	263
8059-WW	269.79	263
805-UTC	19.05	159
8060-WW	273.65	263
806-WW	37.32	268
807-WW	153.92	270
808-10-WW	9.39	281
808-11-WW	9.66	281
808-12-WW	10.05	281
808-13-WW	11.40	281
808-14-WW	12.15	281
808-15-WW	12.75	281
808-16-WW	13.89	281
808-17-WW	14.85	281
808-18-WW	15.60	281
808-19-WW	16.35	281
808-20-WW	18.00	281
808-21-WW	19.65	281
808-22-WW	21.54	281
808-24-WW	24.45	281

808-8-WW	9.00	281
808-9-WW	9.06	281
808-WW	123.12	270
809-WW	79.90	266
810008-UTC	180.47	111
810-2-WW	96.35	287
8107-10-WW	17.31	74
8107-10-WW	17.31	75
8107-11-WW	4.08	74
8107-11-WW	4.08	75
8107-12-WW	8.46	74
8107-12-WW	8.46	75
8107-13-WW	4.83	74
8107-13-WW	4.83	75
8107-14-WW	4.08	74
8107-14-WW	4.08	75
8107-15-WW	17.31	74
8107-15-WW	17.31	75
8107-16-WW	10.62	74
8107-16-WW	10.62	75
8107-17-WW	6.90	74
8107-17-WW	6.90	75
8107-18-WW	6.03	74
8107-18-WW	6.03	75
8107-19-WW	22.47	74
8107-19-WW	22.47	75
8107-1-WW	9.09	74
8107-20-WW	17.31	74
8107-21-WW	2.58	74
8107-22-WW	26.10	74
8107-23-WW	8.04	74
8107-2-WW	4.83	74
8107-2-WW	4.83	75
8107-3-WW	10.65	74
8107-3-WW	10.65	75
8107-4-WW	9.66	74
8107-4-WW	9.66	75
8107-5-WW	12.87	74
8107-5-WW	12.87	75
8107-6-WW	14.43	74
8107-6-WW	14.43	75
8107-7-WW	4.08	74
8107-7-WW	4.08	75
8107-8-WW	17.31	74
8107-8-WW	17.31	75
8107-9-WW	5.58	74
8107-9-WW	5.58	75
8107-WW	143.06	74
810-WW	88.95	287
8113-WW	101.36	308
8114-WW	97.92	308
8116-WW	129.14	108
8117-1-WW	2.19	54
8117-1-WW	2.19	143

8117-WW	63.70	54
8117-WW	63.70	143
811-WW	148.93	9
814-WW	26.16	288
815-1-WW	19.50	173
815-WW	58.60	172
816-1-WW	12.21	283
816-2-WW	15.54	283
816-3-WW	20.25	283
816-4-WW	23.67	283
816-5-WW	19.80	283
816-6-WW	31.71	283
816-7-WW	13.86	283
816-8-WW	17.64	283
816-9-WW	32.37	283
816-WW	66.15	267
817-1-WW	22.05	281
817-2-WW	23.46	281
817-3-WW	27.60	281
817-4-WW	31.11	281
817-5-WW	38.25	281
817-6-WW	40.11	281
817-WW	126.60	270
818-WW	59.25	308
819-WW	238.93	112
820-WW	36.30	140
821-WW	36.87	83
822-WW	42.45	83
823-WW	79.83	83
825-1-WW	43.30	185
825-2-WW	43.30	185
825-WW	38.90	186
826-1-WW	60.35	286
826-WW	51.70	286
827-WW	165.35	302
828-WW	120.92	295
829-WW	120.92	295
830-1-WW	8.19	52
830-WW	65.63	52
831-WW	41.98	140
8396-WW	238.96	149
8397-WW	238.96	149
8398-WW	238.96	150
8399-WW	29.07	304
8400-WW	187.85	150
8401-WW	230.55	150
874-WW	78.80	64
875-WW	7.35	179
876-WW	30.00	180
877-WW	14.55	180
878-WW	26.94	180
879-WW	13.50	181
880-WW	31.89	174
881-WW	31.89	174

8935-WW	241.92	150
8936-WW	82.14	44
8939-WW	247.77	151
8940-WW	34.05	304
8941-WW	2.25	44
90-WW	12.36	221
91003-WW	128.76	297
91005-WW	251.43	297
91006-WW	251.43	297
91007-WW	35.01	285
9101-WW	64.18	193
9102-WW	41.73	159
9103-WW	162.23	42
912-WW	112.58	8
91-WW	15.00	221
92-WW	18.00	221
9910-WW	42.63	77
9910-WW	42.63	290
997-1-WW	98.70	298
997-WW	376.62	300
998-WW	188.96	301

Item Name	Page	Item Name	Page
Warrior™ Air Line Hose; 3/8" x 10m	7	Impact Wrench; Composite, 1/2", 1385 nm	19
Warrior™ 1/2" x 50 ft. Premium Rubber Air Hose	7	Impact Wrench; Ultra Mini, 1/2", 800 nm (Red)	20
Warrior™ 3/8" x 50 ft. Premium Rubber Air Hose	7	Impact Wrench; Ultra Mini, 1/2", 800 nm (Green)	20
Warrior™ Air Line Swivel Attachment; 3/8"	7	Impact Wrench; Ultra Mini, 3/8", 800 nm (Red)	20
Air Line Reel Adjustable Wall Fixing	7	Protective Rubber Cover For 3114-WW	20
Warrior™ Air Hose Reel; Retractable, 3/8" x 10m	8	Air Ratchet; 3/8" Heavy Duty Composite Housing	21
Warrior™ Retractable 3/8" x 50 ft. Premium Rubber Air Hose Reel	8	Air Ratchet; 1/2" Heavy Duty Composite Housing	21
Warrior™ 1/2" x 50 ft. Premium Rubber Air Hose Reel	8	Air Ratchet; 3/8"	21
Welzh 3/8" x 50 ft. Rubber Air Hose & Reel	8	Air Ratchet; 1/2"	21
Air Hose 10-Meters; Blue Bird	9	Air Ratchet; 1/4", Mini Type	22
Air Hose 20-Meters; Blue Bird	9	Air Ratchet; 3/8", Mini Type	22
Air Hose Reel 15M With Blue Bird Hose; Retractable	9	Air Installation Tool For CV Boots	22
Air Hose Reel 15 Meter Retractable	9	Car Tyre Booster	22
Air Inlet Swivel Joint	10	Air Ratchet; Impact Type, 3/8"	23
12-Piece Air Hose Connector Adaptor Set UK Fitting	10	Drill with Keyless Chuck; Air Operated, 3/8"	23
12-Piece Air Hose Connector Adaptor Set EU Fitting	10	Drill With Key-less Chuck; Air Operated, 3/8", Angled	23
Vibration Hammer Chisel Adaptors, 9-Piece	10	Cut Off Tool Composite, Extra Long, 310 mm	23
Vibration Hammer Adaptor 1070-7	11	Die Grinder 6 mm Extra Long Shaft Composite 340mm	24
Vibration Hammer Adaptor 1070-4	11	Die Grinder 6 mm Composite 170mm	24
Vibration Hammer Adaptor 1070-5	11	Die Grinder 90° Angle Composite	24
Vibration Hammer Adaptor 1070-6	11	Die Grinder; Mini Type (Ultra Short)	24
Vibration Hammer Adaptor 1070-3	12	Angle Grinder; Ultra Short	25
Vibration Hammer Tyre Puncture Adaptor	12	Die Grinder; Ultra Short	25
Replacement Chuck For 1070-WW	12	Die Grinder; Micro Type, Pneumatic	25
Pneumatic Bolt Remover G-VIBRO	12	Needle Scaler Composite	25
Injector Removal Tool; Vibration Hammer Edition	13	Air Nibbler	26
Vibration Hammer Exhaust Chisels 2-Piece	13	Metal Shear; Air Operated	26
Vibration Needle De-scaler Attachment	13	Butterfly Gun; 3/8"	26
Vibro Adaptor For Locking Wheel Nuts	13	Mini BAT" Gun 3/8dr"	26
Pin Punches for Use with 1070-WW	14	Pneumatic Rotary Removal Tool	27
Vibration Impact Loosening Lever for Welzh 1070-WW	14	Brake Caliper Rewind Spindle; Air Operated	27
Wall Mount For 1070-WW	14	Sand Blaster; Air Operated, Hand Held, 1/4" NPT	27
Vibration Hammer Adaptors Extra Long, 4-Piece	14	Sander; Mini Type, 3", Air	27
Socket Set for use with Air Hammer (Vibration Impact)	15	Sander; Belt Type (10x330mm), Air Operated	28
Injector Removal Tool Kit; Vibration Hammer Edition	15	Reciprocating Saw, Low Vibration; Air Operated	28
52-Piece Mounting Press Set	15	Body Saw; Air Operated	28
Suspension Screw Extractor for VAG; 4-link Suspensions	15	Reciprocating Saw; Mini Type, Low Vibration	28
Vibration Hammer	16	Tyre Inflating Device; Digital	29
Vibration Hammer & 9-Piece Special Adaptor Set	16	Tyre Inflating Device	29
Vibration Hammer & 14-Piece Special Adaptor Set	16	Air Blow Gun with Brush Nozzle	29
Impact Wrench; Air, 1/2", 1982 nm (The Beast)	17	Air Blow Gun Set; 3pcs	29
Impact Wrench; Air, 1/2", 1982 nm (The Beast) Green	18	Airburst Filter & Radiator Cleaner; 12"	30
Impact Wrench; 1/2", 680 nm, (Mini)	18	Airburst Filter & Radiator Cleaner; 24"	30
Impact Wrench; Air, 1/2", 1600 nm	18	Airburst Filter & Radiator Cleaner; 36"	30
Impact Wrench; 3/4", 1860 nm	18	Airburst Filter & Radiator Cleaner; 48"	30
Impact Wrench with Anvil Head; 1", 2200 nm (Stubby Version)	19	Angle Grinder; Cordless 18v Lithium Battery	31
Impact Wrench with Anvil Head; 1", 2200 nm	19	Polishing Machine; Cordless	31
Impact Wrench; Composite, 1/2", 1350 nm	19	18-Volt Lithium Cordless Drill Kit	32
		Impact Wrench; Cordless Lithium Battery, 1/2", 600 nm	32
		Impact Wrench; Cordless Lithium Battery, 1/2", 540nm	32
		Impact Wrench; Cordless Lithium Battery, 1/2", 982 nm	32

18-Volt Replacement Lithium Battery For WELZH 7036-WW	33
Replacement Battery For 2020-WW	33
Replacement Charger For 2020-WW	33
Replacement Battery For 2116-WW & 4021-WW	33
Battery Charger For 2116-WW & 4021-WW	34
18 Volt Lithium Battery For 5021-WW	34
Replacement Charger For 5021-WW	34
Replacement Battery 10,8 V Li-Ion for WELZH 7035-WW	34
Electric Hot Stapler	36
Dent Removal PDR Kit; 33-Piece Deluxe Paintless	36
12-Piece Plastic Connectors	37
9-Piece Plastic Tab Connector	37
PDR Puller + 9-Piece Plastic Tab Set	37
Sliding PDR Hammer Incl 9-Piece Plastic Tab Connectors	37
Lock Out Tool Kit; Universal	38
7-Piece Dolly Set	38
23-Piece Dent Removal Set	38
PDR Sliding Hammer	38
Trim Removal Set; Stainless Steel, 5pcs	39
6-Piece Extra Long Door Upholstery Trim Tools	39
Plastic Welding Kit	39
12 Piece Plastic Welding Materials for ABS	39
12 Piece Plastic Welding Materials for PP	39
12 Piece Plastic Welding Materials for PE	39
12 Piece Plastic Welding Materials for PS	39
3 Piece Reinforced Mesh, Stainless Steel, 10 x 6 cm	39
Gas Soldering Torch Kit	40
5-Piece Inflating Air Pillow Set	40
Air Suctioned Professional Dent Puller	40
Fender Cover; Magnetic	40
8pc Removal Set	41
Trim Tool Set; 11pcs	41
Trim Tool Set ; 27 pcs	41
Master Auto Dent Repair Kit (ALUM. Hammer)	41
Cordless Electric Hot Stapler	42
Electric Hot Stapler Hand Held Version	42
Wiper Arm Puller	42
Easy Lock™ Wiper Arm Removal Tool	42
6-Piece Universal Wiper Arm Puller Set **UPDATED VERSION**	43
Professional Paintless Dent removal Set	43
Professional Paintless Dent Removal Set	43
12-Piece Air Bag Removal Kit	43
Light Cover Remover Set; 2-Piece	44
Mini Scraper	44
Sanding Block Kit *WerkConnect*; 20pcs	44
Hydraulic Brake Pipe Flaring Tool Kit	44
Hydraulic Ram For 1034-1-WW	45
Hand Held Brake Pipe Flaring Tool	45
Universal Hydraulic Flaring Tool Set	45
Hand Held Brake Pipe Flaring Tool SAE & DIN	45
Pipe Deburring Tool For Use On, copper brass steel plastics	46

Professional Brake Pipe Flaring Tool Kit	46
Universal Flaring Tool	46
Professional Air Brake Bleeder	46
Adaptor for Brake Bleeder E20	47
Adaptor Set For Air Brake Bleeder WELZH 1182	47
3-Piece Offset Brake Bleeding Wrenches	47
Brake Pipe Spanners; 6-Piece Set	47
4-Piece Brake Bleeding Wrench Set	48
6-Piece Brake Bleeding Wrench Set 7-8-9-10-11 MM 6-PT	48
6-Piece Brake Bleeding Wrench Set 7-8-9-10-11 MM 12-PT	48
4-piece Adapter Set for Air Brake Bleeder	48
Manual Brake Bleeder Universal 2-Litre	49
Manual Brake Bleeder Universal 4-Litre	49
Replacement Adaptor: For Hose	49
Replacement Adaptor: For Plastic Housing	49
Brake Caliper Rewind Spindle; Air Operated	50
Brake Bleeding Bottle	50
Gearless Ratcheting Caliper Press Kit	50
Ratcheting Brake Caliper Press	50
Brake Rewind Kit; Air Operated	51
2-Piece Adjustable Brake Pin Adaptors Universal Use	51
Brake Caliper Wind Back Kit	51
Brake Service Master Kit; 50pcs	51
Brake Service Kit; 34pcs	52
Brake Rewind Pin Adaptor For Vag 3-Pins	52
21-Piece Brake Piston Wind Back Kit (INCLUDES UPDATED ADAPTORS)	52
Brake Thread Repair Kit M9X1.25	52
Brake Nipple Repair Kit	53
Brake Nipple Repair Kit +	53
Replacement Nipples For 4017-WW 5-Pieces	53
Replacement Nipples For 4017-1-WW 5-Pieces	53
Electronic Brake Fluid Tester	54
Brake Fluid Boiling Point Tester	54
14-Piece Brake Thread Repair Kit M12x1.5 For Vag Group	54
Spare Insert For 8117-WW	54
6-Piece Brake Caliper Tool	55
Brake Pad Thickness Gauge Tool	55
19pc Terminal Test Kit	55
Electronic Stethoscope	55
23-Piece Terminal Release Tool Set	56
92-Piece Multi purpose Electronic Cable Set	56
Automotive Crimping Tool Set with 5 Pairs of Jaws	56
Supaseal Ratchet Crimping Pliers	56
Cordless Circuit Tester	57
Digital LCD 12-24V Wide Range Circuit Tester	57
Digital LCD 3-49Volts Wide Range Circuit Tester	57
Cordless Circuit Tester; Heavy Duty	57
Digital Multimeter	58
12-Volt Automotive Power Surge Protector	58
Multi Function Automotive Test With Temperature Measurement	58

Digital Multifunction Voltage Tester	58	Removal/Installation Tool for Fuel Return Line For VAG Models	71
Digital Battery Tester	59	38-Piece Brush Assortment Set	72
17-Piece Turbo System Test Set 16-22 mm	59	Brush Assortment Set; 38 pcs	72
Leakage Tester For Engine Charging Systems	59	Injector Clamping Bolt Thread Repair Kit - Mercedes Benz CDI	72
Suction Pump For Opel & Vauxhall	59	Replacement Insert Set From 60013-WW 5-pcs	72
Diesel Engine Compression Tester Kit For Common Rail Engines CRD	60	Injector Removal Kit with Slide Hammer and Adapters; 14 pcs	73
Replacement Compression Meter from 4003-WW	60	Injector Removal Kit with Slide Hammer and Adapters; 24 pcs	73
Diesel Engine Compression Master Test Kit	60	Universal Diesel Priming & Bleeding Kit	73
Replacement Gauge From 800004-UTC	60	Master Fuel Connector Repair Kit	73
Common Rail Flow Meter Set Updated Version	61	Injector Seat Cleaners; VAG Engines, 2.0L Common Rail	74
Common Rail Flow Meter Set	61	Injector Copper Seal Kit; 150 pcs	74
Master Diesel & Petrol Compression - Leakage Test Kit	61	Injector Seal Kit; Master Kit, 551 pcs	74
Engine Fuel Pressure Gauge, 0-8 bar	61	30x Ø15.0x8.0x1.5 Universal	74
Diesel Engine Compression Tester Set	62	12x Ø15.0x7.0x1.5 - Mercedes	74
Common Rail Diagnostic Set	62	30x Ø13.0x7.5x2.5 - Renault	74
Oil Pressure Test Kit	62	30x Ø15.0x7.5x1.5 - Iveco Ford BMW MAN	74
Petrol Engine Compression Tester	62	30x Ø15.0x7.5x2.0 - Iveco Ford BMW MAN	74
13-piece Alternator Pulley Bit Set	63	30x Ø15.45x8.0x2.0 - Universal	74
30-Piece Alternator Pulley Set	63	12x Ø13.5x10x2.0 - Mazda	74
22-Piece Alternator Pulley Set	63	30x Ø15.5x7.5x2.5 - Ford	74
18 Piece Radio Removal Set	63	12x Ø15.5x7.5x1.5 - Land Rover	74
Micro Gas Torch With 162-Piece Heat Shrink Kit	64	30x Ø15.0x7.5x3.0 - Renault	74
Mapp Hand Torch	64	12x Ø13.0x7.0x1.5 - Deutz	74
Connector Removal Tool VAG & Porsche	65	30x Ø13.5x7.5x1.5 - Ford	74
Pump For Radiator Pressure Test Kit 1005-WW	65	12x Ø15.0x7.5x1.5 - Fiat	74
24 Piece Radiator Pressure And Cooling System Tester	65	12x Ø15.5x7.5x1 - MAN Rover	74
18-Piece Radiator Pressure Test Set	65	30x Ø16.5x7.5x2 - Mercedes	74
7-Piece Updated Radiator Adaptor Set	66	12x Ø13.7x7.3x2 - Kia	74
Vacuum / Pressure Pump Kit	66	12x Ø13.7x7.3x2 - Kia	74
Universal Radiator Smart Cooling System Pressure Tester Kit	66	50x Ø10x6.0x1.0 - steel rings	74
Cooling System Flushing Gun	66	30x Ø15.8x7.5x3.0 - brass rings	74
Cooling System Tester Pump	67	20-Universal - plastic injector T-shape	74
14-Piece Universal Cooling System Tester	67	Aluminium Washers x 30	74
9-Piece Truck Cooling System Tester Set	67	30-Universal- plastic injector L-shape	74
Common Rail Diagnostic Set	67	Springs 25pcs	74
Injector Seat Cleaners; 17 pcs	68	Generation 2 Oil Filter Set 19-Piece	75
Injector Seat Cleaners; 6 pcs	68	Oil Filter Wrench; 24 mm x 6	75
Injector Shaft Wire Brush Cleaning Set	68	Oil Filter Wrench; 27 mm x 6	75
Injector Service Kit; Bosch, Delphi, Denso, Siemens	68	Oil Filter Wrench; 30 mm x 6	75
Injector Remover for Bosch Injectors; Diesel	69	Oil Filter Wrench; 32.5 mm x 6	75
Injector Removal Kit; CDI Injectors	69	Oil Filter Wrench; 36 mm x 6	75
Injector Pump Puller; VAG Engines	69	Oil Filter Wrench; 38 mm x 6	75
Injector Removal Kit; HDI Injectors	69	Oil Filter Wrench 16 Flutes, BMW-Volvo, 87mm, 915	75
Common Rail Flow Meter Set Updated Version	70	Oil Filter Wrench; 64.5 x 14, For Toyota, 901-T	75
Common Rail Flow Meter Set	70	Oil Filter Wrench; 64.5 x 14, For Toyota, 901-L	75
Injector Removal Master Kit; Bosch, Delphi, Denso, Siemens	70	Oil Filter Wrench; 66.5 x 14, for Ford/Mazda, 902	75
Injector Removal Adaptors; Universal	70	Oil Filter Wrench For Mercedes Benz; 74mm, 903B	75
Injector Seal Extractor	71	Oil Filter Wrench; 87-88 mm, 901-1	75
Injector Removal Tool; Vibration Hammer Edition	71	Oil Filter Wrench; 3 legged, Universal, 63-83 mm, 917	75
Injector Removal Tool Kit; Vibration Hammer Edition	71	Oil Filter Wrench; 100.5 mm, 05101	75

Oil Filter Wrench, 94.5 mm, 0595	75
Oil Filter Wrench, 84mm, 1284	75
Oil Filter Wrench, 92 mm, 0952	75
Oil Filter Wrench, 79mm, 0579	75
Oil Filter Wrench; Universal, 3 legged	75
Oil Filter Wrench Set; 3rd Generation	76
Master Plastic Oil Drain Plug Kit	76
Assembly Tool for Plastic Oil Drain Plugs	76
Plastic Oil Drain Plug	76
Oil Mate 16-Litre Oil Pan & Holder For Transmission Jack	77
16-Litre Fuel Pan	77
16-Litre Oil Pan	77
12 Volt Oil Pump	77
Transmission Filling Adaptors 8-Piece	78
Transmission Oil Filler with 9-piece Adaptor Set 9.5Ltr	78
70 Litre Waste Oil Drain Receiver	78
70 Litre Mobile Suction Evac Oil Drainer, Air support	78
Suction & Filling Car Fluid Syringe	79
Fluid Transfer / Extractor Pump Set	79
Syringe for Fluid and Oil; 200 cc	80
Suction & Filling Syringe For Diesel Fuel Systems Incl 3 Adaptors	80
AdBlue Syringe 1.5L	80
Oil Filter Wrench For Opel	80
Oil Filter Cap Wrench Ø64.5mm x 14 Flutes - Lexus/Toyota *Heavy Duty Design*	81
30-Piece Oil Filter Wrench Kit	81
Oil Filter Wrench DSG/VAG - Stubby Version	81
Oil Filter Wrench DSG/VAG	81
Universal Oil Filter Funnel	82
Oil Filter Wrench For 27 mm	82
7-Piece Low Profile Oil Filter Wrench Set	82
Oil Filter Chain *Professional Use* 60-115 mm	82
Oil Filter Wrench 3-Leg	83
Oil Filter Wrench; Universal, 60-80 mm	83
Oil Filter Wrench; Universal, 80-98 mm	83
Oil Filter Wrench; Universal, 100-140 mm	83
40-Piece Glow Plug Removal Kit M8-M10	84
Impact Vibration Glow Plug Removal Gun Incl Sockets 8-12 mm	84
Universal Glow Plug Extraction Master Kit	84
33-Piece Glow Plug Thread Repair Kit	84
Glow Plug Thread Repair Kit M8, M9, M10, M12	85
Glow Plug Removal Set for Damaged Glow Plugs	85
Damaged Glow Plug Removal Set	85
Ratcheting Exhaust Cutter	85
Exhaust Expander Set 3-Piece	86
Universal Diesel Priming & Bleeding Kit	86
Fuel Gauge & Pump Sender Collar Wrench	86
Turbo Actuator Adjustment Set - VAG	86
Universal Valve Spring Installer and Remover Tool Set	87
Mercedes Benz Valve Adjusting Wrench	87
Valve Lapping Tool Attachment	87

21-Piece Oil Drain Plug Key Set	87
Dipstick for Audi and VW with Oil Level Indicator	88
4-Piece Oil Dipstick Set For Mercedes Benz	88
4-Piece Oil Dipstick Set For Mercedes Benz	88
2-Piece Fuel Filter Tool for Diesel JTD / CDTi / DDiS / TiD / VCDi / Hdi	88
Fuel Filter Removal Tools for Ford Transit (Custom)	89
Fuel Filter Removal Tool For VW Crafter & Volkos	89
Fuel Filter Removal Tools for PSA Group 2.2 HDi Engines	89
Fuel Filter Removal Tools for Mercedes Benz 2.2 CDI	89
UFI Fuel Filter Cover Installation Lever	90
Removal/Installation Tool for Fuel Return Line For VAG Models	90
Master Fuel Connector Repair Kit	90
Cylinder Head Leakage Tester Replacement Fluid	90
Cylinder Head Leakage Tester	91
Bushing Tool Kit For VW Polo N9	92
Silent Block Tool for Renault Laguna II	92
Silent Block Tool For Bmw	92
Silent Block Tool for VAG; 18 pcs	92
Bush Tool for Rear Axle on Ford Fiesta MK6 2008 onwards	93
Bush Kit for Vauxhall 2004-14; Rear Axle	93
Trailing Arm Bush Tool Ford Mondeo MK4 & Galaxy S-Max	93
Bushing Kit for Mondeo and Galaxy S-Max	93
Bush Kit for Rear Axle on Ford Focus	94
Ford Focus & Mazda 3 Trailing Arm Bush Removal / Installer Set	94
Bush Tool for Volkswagen Golf 5	94
Universal Press & Pull Sleeve Set	94
Universal Press & Pull Sleeve Set For Commercial Use	95
Press And Pull Sleeve Set; 26 pcs	95
27-Piece Universal Press & Pull Sleeve Set	95
Replacement Spindle Set M10, M12, M14, M16	95
M10 Spindle For 67305 With Thrust Bolts	95
M12 Spindle For 67305 With Thrust Bolts	95
M14 Spindle For 67305 With Thrust Bolts	95
M16 Spindle For 67305 With Thrust Bolts	95
M18 Spindle For 67305 With Thrust Bolts	95
Universal Press Support Frame	96
Adapter for Ford Focus and Mazda 3 Rear Bushes - Installation and Removal	96
Adapters for 67306-WW For Mercedes Sprinter, VW Crafter	96
Ford Transit Lower Arm Bush Tool For Use With 67306-WW	96
Wheel Hub Puller With Heavy Duty Sliding Hammer	97
Hub Puller; 12 ton Hydraulic Ram	97
Hub Puller Base From 1017-WW	97
Hub Puller Tool; 12 ton Hydraulic, LGV	97
Hub Puller with Hydraulic Ram and Slide Hammer; New Base Size	98
Hub Arbieter™	98

Compact Wheel Bearing Kit; 62, 66, 67, 72, 78, 82, 85 mm GEN2	98	Strut Mate™	109
Compact Wheel Bearing Kit; 62, 66, 72, 85 (VAG Master Kit) GEN2	98	Wheel Separator for Dual Wheels	109
Compact Wheel Bearing Set 72mm GEN2	99	Clamp For Strut Insert Pistons	110
Compact Wheel Bearing Kit; 85 mm GEN2	99	Clamp for Strut Insert Pistons - 60mm	110
Compact Wheel Bearing Kit; 78 mm GEN2	99	5-Piece Strut Nut Tool Set - Audi, VW, Mercedes	110
Compact Wheel Bearing Kit; 82 mm GEN2	99	Steering Wheel Level	110
Compact Wheel Bearing Kit; 90 mm GEN2	100	Coil Spring Compressor (Wishbone Version)	111
Compact Wheel Bearing Kit; 62, 66, 72 mm GEN2	100	Mercedes Spring Compressor	111
Bearing Puller for Ford Transit Inner Front Wheel Bearings	100	Inter Link Coil Spring Compressor	111
Compact Wheel Bearing Kit; Ford Transit, GEN2	100	7pc Heavy Duty Coilspring Compressor	111
Bearing Removal Tool for Ford Transit Custom Front Hubs	101	Coilspring Compressor; Floor Standing, 1500 kg	112
Bearing Install and Removal Tool Kit; Universal, 23pcs	101	Flexi Jaw Coilspring Compressor	112
Bearing Tool Kit; Universal, 31pcs	101	Ball Joint Splitter; 23x55 mm	112
52-Piece Mounting Press Set	101	Ball Joint Splitter; 28x55 mm	112
Bearing Mounting Press Set; 52pcs	102	Ball Joint Splitter; 34x63 mm	113
64-Piece Mounting Press Including Vibration Adaptor	102	Ball Joint Splitters; 3pcs	113
21-Piece Extra Large Mounting Press Set	102	Ball Joint Splitter; 23x55 mm	113
Bearing Separator Kit; 14-Piece	102	Ball Joint Splitter; 28x55 mm	113
Bearing Separator Kit; 5pcs, 6.35 to 228.6 mm	103	Ball Joint Splitter; 34x63 mm	113
Bearing Separator 10-30 MM	103	3-Piece Ball Joint Separators	113
Bearing Separator 30-50 MM	103	Balljoint Splitter 8 Ton Hydraulic	113
Bearing Separator 50-75 MM	103	Ball Joint Separator 2-Stage	114
Bearing Separator 75-105 MM	103	Vibration Impact Ball Joint Puller 39mm	114
Bearing Separator 105-150 MM	103	Hydraulic Ball Joint Splitter 12-Ton	114
Bearing Separator 150-200 mm	103	Ball Joint Kit; T4, T5, LT	114
Universal Ring Puller GOLD-EDITION	103	Ball Joint Remover and Installer for Volvo	115
Bearing Race and Seal Driver; Universal, Adjustable	103	Ball Joint Assembly Set; 21-Piece	115
Bearing Puller for Blind Hole Bearings; 16pcs	104	Balljoint / Tie Rod Separator Set 5-Piece	115
Bearing Puller for Blind Hole Bearings; 5pcs	104	Ball joint Separator Kit; 5-Piece	115
Puller Set; 10 ton Hydraulic	104	Vibration Impact Ball Joint Separators 20-42mm	116
Puller Set 2 & 3 Legged; 12-Piece Universal	104	CV Joint Puller	116
16-Piece Slide Hammer Puller Set	105	Air Installation Tool For CV Boots	116
G-Hook	105	Tie Rod Spanner 4-Link Suspension On VAG Models	116
Heavy Duty Slide Hammer **For Use with WELZH Adaptor Kits**	105	Hub Mate Supporting Adaptor Device	117
Adaptor To connect 1017-ww & 1017-1-WW	105	Wishbone Off-Set Lever Bar Pat*	117
Clutch Alignment Tool	105	Wishbone Lever; Universal	117
Self Adjusting Clutch Tool	106	Camshaft Holders; Universal	119
Self Adjusting Clutch Tool Kit	106	Universal Pulley Puller	119
SAC Clutch Repair & Alignment Tool	106	Timing Pulley Puller	119
Clutch Alignment Tool For Trucks	106	Universal Stretch Belt Tool	119
Dual Mass Fly Wheel Tool	107	V-Ribbed Belt Mounting Tool Set	120
Rack End Removal and Install Kit, 28-35 mm	107	13-Piece Diesel Pump Timing Set	120
Axle Joint Tool 35-45 MM	107	Spanners for Poly-V-Belts	120
Steering Wrack End Remover Tool 22-55 mm	107	Fuel Tank Sender Unit Spanner Set	120
Tie Rod Remover; Inner, 27-42 mm	108	Engine Timing Tool Kit for VAG 1.0 / 1.2 / 1.4 L	121
Rack End Removal and Install Kit, Universal	108	Volkswagen, Audi, Seta And Skoda Master Timing Tool Set Petrol and Diesel Engines	121
Rack End Removal Tool for HGV's	108	Volkswagen, Audi, Seat And Skoda, 1.9 & 2.0 TDI Timing Kit	121
Shock Absorber Tool Kit	108	VW / AUDI FSI 2.0 Timing Tool Set	121
6MM Hexagon Socket From 8109-WW	109	VAG Engine Timing Tool Set For 1.6 & 2.0 Common Rail Diesel	122
		Engine Timing Tool Set for VAG 1.8 / 2.0L FSI / TFSI	122
		Engine Timing Tool Set for VW Polo, Lupo 1.2 L 3-Cylinder engines	122

VAG Engine Timing Tool Set For 2012 CR TDi Engines 1.6 & 2.0	122
VAG Engine Timing Tool Set For 1.2 TFSI	123
VAG Engine Timing Tool Set For 1.8/2.1 4V TFSI Engines	123
VAG 1.8/2.0 TFSi Petrol	123
2-Piece Ignition Coil Puller For Opel-Vauxhall	123
Engine Timing Tool Set For Vag 1.4 / 1.6 FSI	124
Engine Timing Tool Set For VAG 2.5, 4.9, TDI PD	124
Engine Timing Tool for VW and Audi, 1.2/1.4/1.6 FSI and 1.4 TSI	124
Citroen & Peugeot Timing Set	124
Engine Timing Tool Set Citroen / Peugeot	125
Citroen & Peugeot Timing Tool Set 1.8, 2.0, 2.2 EW7, EW10, EW12 Petrol	125
Citroen & Peugeot Master	125
Renault Master Timing Set	126
Opel Renault Nissan 1.5/1.9/2.2/2.5 DCI (VANS) Timing Tool Set	126
DCI Timing Set (Renault)	126
Engine Timing Tool Set Renault 1.4/1.6/2.0 16V	127
Diesel Engine Setting-Locking Tool Set For Renault-Nissan 1.5-1.9dci, Suzuki DDis, Dacia Dci Belt Driven	127
Flywheel Front Pulley Locking Tool Set - Renault & Nissan	127
26-Piece Engine Timing Tool Set For BMW Engines, N42, N46	127
Diesel Injection Fuel Pump Puller BMW	128
Engine Timing Tool Set for BMW N43	128
Diesel Engine Setting-Locking Tool Set For BMW N47-57, 2.0-3.0 Itr Chain Drive	128
Engine Timing Tool Set For Bmw-Mini-Citroen-Peugeot 1.4/1.6 N12	128
Engine Timing Tool Set for BMW M52; M54; M60; M62	129
Engine Timing Tool Set for BMW N42 / N46 / N46T	129
BMW Timing Tool Set S54	129
Engine Timing Tool Set For Opel / Vauxhall 1.0/1.2/1.4 Chain Driven Petrol Engines	129
Opel/ Vauxhall 26-piece timing tool set	130
Timing Tool Set For Opel / Vauxhall 1.0,1.2, 1.4 Twin Cams	130
Diesel Engine Setting Locking Tool Kit For Vauxhall/ Opel, Saab, Fiat, 1.9, CDTi/Tid/TTid, 2.0D,CDTi Belt Drive	130
Engine Timing Tool Set For Opel 1.6, 1.8 16v Z series	130
Engine Timing Kit Vauxhall/Opel 1.6CDTi	131
Opel / Vauxhall Engine Timing Tool Set	131
Engine Timing Chain Tool Kit - Vauxhall/Opel1.6 SIDI Petrol	131
Engine Timing Tool Kit - Vauxhall/Opel 2.0CDTi	131
Vauxhall, Opel, Nissan, Renault Timing Tool Set For 2.0DCi M9R Engines	132
Petrol Engine Setting/Locking Kit Alfa Romeo Fiat Lancia 1.2 16v,1.4 16v 1.4 T Jet - Belt	132
High Pressure Pump Sprocket Puller For Common-Rail Hyundai & Kia	132
Diesel engine locking Set	132

Engine Timing Tool Set For Ford / Volvo 1.6 Eco-boost	133
Engine Timing Tool Set For Volvo T4 and T5	133
Engine Timing Tool Set For Ford EcoBoost 2.0L	133
Engine Timing Tool Set For Ford	133
Belt Tensioner Wrench, Ford Duratorq Engines	134
Engine Timing Tool kit - Ford EcoBoost 1.0 Belt Drive 3 Cylinder	134
5-piece Engine Timing Tool Set for Ford Focus 1.6 TI-VCT & 2.0 TDCI Engines	134
Diesel Engine Timing And Injection Pump Tool Kit For Ford Duratorq 2.0	134
Stretch Belt Fitting Tool Dual Size Pulleys	135
Engine Timing Tool Kit Ford Transit 2.2 TDCI	135
Ford Engine Timing Tool Set Tdci	135
Diesel Engine Timing Tool Set for Fiat, Ford, Opel, Suzuki 1.3 Diesel	135
Engine Timing Tool Kit For Ford / Volvo 2.5 Turbo	136
Engine Timing Tool Set For MINI / PSA Engines N12	136
Engine Timing Tool Set BMW/Mini W16D	136
Petrol Engine Timing Kit For BMW, Mini, Citroen, Peugeot Chain Driven	136
Engine Timing Tool Set For VAG 2.4 & 3.2 FSI	137
Engine Timing Tool Set For VAG 2.7 & 3.0 TDi	137
Timing Tool Set for Mercedes-Benz	137
Timing Chain Guide For Mercedes Benz 651	137
Engine Timing Tool Set for Mercedes M271	138
Petrol Engine Setting-Locking Tool Set For Fiat, Ford, Lancia 1.2-1.4, 8v- Belt Drive	138
Diesel Engine Setting/Locking Tool Kit - Land Rover & Jaguar TDV8 3.6 - Chain Drive	138
Engine Timing Tool Kit For Land Rover & Jaguar 2.0 GTDi	138
38-Piece Brush Assortment Set	140
Brush Assortment Set; 38 pcs	140
Wire Brush Set; 24pcs	140
24-Piece Wire Brush Set	140
Wheel Hub Resurfacing Kit	141
114-Piece Oil Sump Repair Kit	142
48pc Oil Repair Set	142
Oxygen Sensor Thread Repair Set	142
40-Piece Tap & Die Set	143
8-Piece Thread Repair Kit For Drive Shafts	143
14-Piece Brake Thread Repair Kit M12x1.5 For Vag Group	143
Spare Insert For 8117-WW	143
Die Holder 38x14mm	144
Die Holder 25x9mm	144
Tap Wrench Holder M6-M20	144
Tap Wrench Holder M3-M12mm	144
Universal Outside Thread Chaser	144
110-Piece Metric & SAE Tap + Die Set	145
45-Piece Tap + Die Set M6-M24	145
110-Piece Metric Tap + Die Set M2-M18	145
30-Piece Metric Tap & Die Set M3-M12	145
Wheel Stud Master Re-Threader Kit	146
131-Piece Thread Repair Set	146

64-Piece Oil Plug Thread Repair Set	146	Brake Line Bending Pliers	159
Drill Bit Set; Fully Ground, 170 pcs	146	Space Saving Hose Clip Pliers	159
Drill Bit Set; Fully Ground, Left Hand Cutting, 5pcs	147	Hose Clamp Pliers Clic R Type	159
Drill Bit Set; Fully Ground, Left Hand Cutting, 19pcs	147	3-Way Hose Clamp Compressor	160
Drill Bit Set; Cobalt, 19 pcs	147	Hose Clamp Compressor 85mm	160
Drill Bit Set; Fully Ground HSS, Titanium Coated; 230 pcs	147	Hose Clamp Compressor 60mm	160
Drill Bit Set; Fully Ground; Cobalt, 170 pcs	148	Angled Composite Hose Locking Pliers	160
Drill Bit Set; Fully Ground; Cobalt, 25 pcs	148	Multi-purpose Hose Clamp Pliers	161
Drill Out Kit with Guides; Universal	148	Ergonomic Ratchet Pipe Clamps	161
Step Drills; Titanium, 4-30mm	148	Multi Direction Hose Clamp Pliers	161
Replacement Disk 4mm Thickness	149	Flex-Clamp Pliers	161
Replacement Disk 1mm Thickness	149	Hose Removal Pliers	162
Flap Disk, Type 29, Aluminium Oxide 40 Grit Ø 115 mm (200 per Box)	149	Universal Hose Clamp Pliers	162
Flap Disk, Type 29, Aluminium Oxide 60 Grit Ø 115 mm (200 per Box)	149	Flexible Hose Clamp Pliers	162
Flap Disk, Type 29, Aluminium Oxide 80 Grit Ø 115 mm (200 per Box)	150	Hose Clip Pliers; Long Reach, Interchangeable Heads	162
Cutting Disk For Stainless Steel 230x 2.0 x 22.2 mm WerkConnect™ (100 per box)	150	Flexible Hose Clamp Pliers Clip Type	163
Cutting Disk For Stainless Steel 125x 1.0 x 22.2 mm WerkConnect™ (400 per box)	150	2pc Hose Clamp Set	163
Cutting Disk For Stainless Steel 115 x 1.0 x 2.2 mm WerkConnect™ (400 per box)	150	9-Piece Hose Clamp Pliers Kit	163
Cutting Disks 75x1.0mm x 9.5mm WerkConnect™ 600-Piece Extra Thin	151	Click-R Collar Pliers	163
Burrs; Carbide for Use with 3020-WW, 10pcs	151	Hose Clamp Pliers 3-Piece	164
Burrs; Carbide, Short, 7pcs	151	Professional Long Reach Hose Clamp Pliers With Cable	164
Burrs; Carbide, Long, 7pcs	151	Long Reach Hose Clamp Pliers For Turbo Pipes On VAG Group	164
Dead Blow Mallet With Fibre Glass Shaft 3.8kg	152	Long Reach Hose Clamp Pliers	164
Dead Blow Hammer Set; 4-Piece	152	4-Piece Circlip Pliers Set, 175mm	165
Dead Blow Hammer; 1/2 lbs.	153	4-Piece Circlip Pliers Set, 150mm	165
Dead Blow Hammer; 1 lbs.	153	4-Piece Circlip Pliers Set, 225mm	165
Dead Blow Hammer; 2 lbs.	153	4-Piece Circlip Pliers Set, 300mm	165
Piston Hammer; 32 oz.	153	12-Piece circlip pliers set	166
Digital Vernier Caliper with Digital Display	154	6-Piece Circlip Pliers Set -130mm-160mm-230-mm	166
Professional long Arm Riveter Set, 3.2-6.4 mm	154	Circlip Pliers 90-Degree Internal	166
Lazy Tong Riveter	154	Pliers For Locking Rings	166
Professional Hand Riveter	154	Lock Ring Pliers Set 90, 30, + Straight Tipped	167
Swivel Head Oil Filter Pliers	155	Locking Ring Tool	168
CV Boot Pliers	155	4-Piece Locking Grip Pliers Set	168
Exhaust Hanger Remover	155	5-Piece Locking Grip Pliers Set	168
Flexi Head Fuel & Filter Pliers (commercial use)	155	Parrot Nose Locking Pliers	168
Special Exhaust Clamp Pliers For PSA	156	16-Piece Vice Grip Pliers Set	169
Tire Valve Cutting Pliers	156	Heavy Duty Water Pump Pliers 20" Inch	169
Magnetic Oil Drain Pliers	156	3-Piece Water Pump Pliers With Locking Function	169
Brake Spring Washer Pliers	156	Pliers for Water Pumps; 20"	169
Brake Pipe Bending Pliers 3/16", 1/4", 5/16", 3/8"	157	4-Piece Water Pump Pliers Set	170
Exhaust Pipe Clamp Removal Pliers	157	Pliers for Water Pumps; 16" (Heavy Duty)	170
CV Boot Clamp Pliers 260mm	157	3-Piece Pliers Set	170
Plastic Door Trim Pliers With Swivel Head	157	5 Piece Long Nose Pliers Set	171
Fuel Line Pliers	158	3-Piece High Leverage Pliers	171
Door Trim Pliers	158	3-Piece X-Type Pliers	171
Pliers for Spark Plugs; Long Nose Type, 3pcs	158	3-Piece Needles Nose Pliers Set 225mm	171
Drive Shaft Squeezing Pliers	158	Pliers; Long Nose, Double Joint, 3pcs	172
Swivel Head Oil Filter Pliers	159	Side Cutters; Double Joint, Long Nose, 290 mm	173
		Automotive Crimping Tool Set with 5 Pairs of Jaws	173
		Supaseal Ratchet Crimping Pliers	173
		3-Piece Diagonal Cutting Pliers Set	173

Ratchet Crimping Tool 0.5-6 mm ² (For None Insulated)	174
Ratchet Crimping Tool, 0.5 - 6 mm ² (For Insulated)	174
36 Inch Heavy Duty Pry Bar	174
36 Inch Angled Heavy Duty Pry Bar	174
4pc Heavy Duty Pry Bar Set	175
Heavy Duty Pry Bar 8" Inch	175
Pry Bar Set; 4-Piece Heavy Duty 2x900mm & 2x600mm	175
Tire Lever with Polymer Protector; 535 mm	175
Extendable Pry Bar With Rotating Head 63-94 MM	176
Extendable Pry Bar With Rotating Head 34-47 MM	176
Extendable Pry Bar With Rotating Head 86.5-135 MM	176
Pry Bar Set; 4pcs	176
36 Inch Angled Pry Bar	177
Flexible Magnetic Pick Up Tool	177
Bendable Magnetic Pick Up Tool	177
Magnetic Pick Up Pen	177
3-piece LED Tweezers Set	178
Telescopic Magnetic Pick Up Tool - 5-Pieces	178
Telescopic Magnetic Pick Up Tool	178
Flash Light With Magnetic Pick Up Tool	178
10-LB Magnetic Pick Up Tools	179
Magnetic Pick-up Tool - 2.5 lb, Claw, Magnet, Light	179
5-Piece Extra Long Pick Set	179
Pick Set; Mini Type, 4pcs	179
Pick and Hook Set; Extra Long, 10pcs	180
Pick and Hook Set; 6pcs	180
Pick and Hook Set w/ Scraper; 9pcs	180
12-Piece Needle Precision File Set	180
File Set; 5pcs	181
28-Piece Heavy Duty Punch & Chisels	181
18-Piece Professional Punch Set	181
Knife; Folding with Clip, inc. Blades	181
Screwdriver Set; L-Handle, 2-10 mm, S2	182
7-Piece L-Handle Tamper Torx & Torx Set T10-T40 S2	182
8-Piece T-Handle Hex Key Set	182
7-Piece T-Handle Torx key Set	182
Screwdriver Set; Diamond Tipped, Extra Long (10pcs)	183
7-Piece Ultra Low Profile Torx Handles T10-T40	183
Screwdriver Set; T-Handle with Interchangeable Heads	183
Screwdriver Set; T-Handle with Interchangeable Heads, Torx	183
Screwdriver Set; JIS Type	184
Screwdriver Set; Precision Type with Picks	184
Screwdriver Set; Torx	184
Screwdriver Set; Go-Through, 12pcs	184
Screwdriver Set; Flexi-Tips with Bits	185
Screwdriver Set; Tamper Proof Torx	185
Screwdriver Set; Go-Through, Green, 12pcs	185
Screwdriver Set; Go-Through, Orange, 12pcs	185
Screwdriver Set; Go-Through, Black, 12pcs	186
Screwdriver, Hex Key & Bit Set, 44-Piece	186

Bit Key Set; Lok-Typ™, 1.5-10 mm	186
9-Piece Extra Long L-Type Key Set, T-Star T10-T50	186
9-Piece Extra Long L-Type Key Set, Hex H1.5-H10	187
9-Piece L-Type Key Set, Ball Hex H1.5-H10	187
9-Piece L-Type Key Set, Hex H1.5-H10	187
9-Piece L-Type Key Set, T-Star T10-T50	187
9-Piece Extra Long L-Type Key Set, Ball Hex H1.5-H10	188
9-Piece Hex Key Wrench Set 1-10mm S2	188
13-Piece Torx Key Wrench Set T6-T50 S2	188
9-Piece Hex Key Wrench Set	188
16-Piece T-Handle T-Star & Hexagon	188
9-piece 1/4 & 3/8" Dr Socket Bit"	190
28-Piece Bit Socket Torxs Plus	190
Socket Set, Torx Bits®, S2 Steel, T6-T70	190
Socket Set, Torx® Plus Bits, S2 Steel, 8IP-60IP	190
Socket Set, Torx®; 3/8", E4-E24, S2 Steel	191
Socket and Bit Master Set; Torx®, S2 Steel	191
Bit Socket Set; Torx®, Stubby Type	191
Bit Socket Set; Torx®, Ball Ended, 130 mm, 1/4"	191
Bit Socket Set; Torx Set® T6-T70 110mm Length S2 Zinc Steel	192
Hex Key Set; 48 mm, H3-H10	192
Bit Socket Master Set; 17pcs	192
Socket and Bit Set; Torx; 1/2", 19pcs	192
Bit Socket Set; Impact, Torx, T30-80	193
Bit Socket Torx Set; Low Profile, Impact, T10-50	193
Bit Socket Set; 3/8dr Torx Set 48mm T20-T45	193
Socket Set; Impact, Torx, E10-24, 9pcs	193
Bit Socket Torx Assortment; 1/2" 32-Piece	194
12-piece Tamper Torx Set T8H-T60H S2 Zinc Steel	194
Bit Socket Set; Extra Long Torx, Hexagon, Ball-Ended Hexagon 110mm	194
Bit Socket and Adapter Set	194
Bit Socket Set; 3/8dr Extra Long Torx Set 110mm T20-T45	195
Bit Socket Master Set; Impact, 6pt, Spline, Torx	195
Bit Master Set; 81 pcs	195
Bit Socket Assortment Set; 44 pcs	195
Bit Socket Set; 6pt, Stubby Type	196
Bit Socket Hex Assortment; 1/2"	196
Bit Socket Set; Master Hex Bit Set 110 mm Length	196
Bit Socket Set; Impact, 6pt, H5-18	196
Bit Socket Hex Set; Low Profile, Impact, 6-19mm	197
Hex Assortment Set 3/8dr	197
Bit Socket Set; 3/8dr Extra Long Allan Key Set 110mm H3-H10	197
Bit Socket Set; 3/8dr Extra Long Ball Allan Key Set 110mm HB3-HB10	197
Bit Socket Set; 3/8dr Ball Allan Key Set 48mm HB3-HB10	197
88-piece 1/2" Bit Socket Sets: Spline	198
Bit Socket Spline Set; Low Profile, Impact, M4-18	198
Bit Socket Spline Assortment; 1/2" M5-M16	198
Bit Socket Set; Impact, Spline, M5-18	198
Bit Socket Set; 3/8dr Extra Long Spline Set 110mm M4-M10	199

Bit Socket Master Set; Spline, 12pcs	199	Impact-Adaptor, 3/4" int. - 1" ext	212
Bit Set; 1/2" and 3/8"; Hex, Torx and Spline; S2 Steel Range	199	Impact-Adaptor, 1" int. - 3/4" ext	212
Bit Set; Impact, 1" and 3/4" 16-Piece Set	200	Adapter Set; Impact, 1/4"-3/4"	212
Bit Master Set; Spline, Hex, Torx, Tamperproof Torx, 54pcs	200	Socket Set; 3/8", Deep, Impact (Lok-Typ™) 8-19 mm	213
Bit Set; 40pcs	200	Socket Set; Impact, Extra Stubby, 3/8"	213
Bit Set; Coloured, 32pcs	200	Socket Set; 1/2", Deep, Impact (Lok-Typ™) 10-32 mm	214
Bit Socket Set; 1/4"	201	Socket Set; Impact, Extra Stubby, 1/2"	214
Bit Socket Set; Master Spline Bit Set 110 mm Length	201	Socket Set; Impact, 6pt, Deep, 10-32 mm, 1/2"	214
Bit Socket Set; Master Ribe Set 110 mm Length	201	Socket Set; Deep, Impact, Dynamic Wall Drive, 10-32 mm	214
Socket Adaptor 1/4" (Internal) X 3/8" (External)	202	Socket Set; Deep Impact, 1/2", 12pt, Dynamic Wall Drive, 10-32 mm	215
Socket Adaptor 3/8" (Internal) X 1/4" (External)	202	Socket Set; Extra Long (120 mm), Impact, 1/2"	215
Socket Adaptor 1/2" (Internal) X 3/8" (External)	202	Socket Set; Shallow, Impact, 1/2", Lok-Typ, 10-32 mm	215
Socket Adaptor 3/8" (Internal) X 1/2" (External)	202	Semi Deep Thin Walled Impact Sockets, 1/2", 6pt	215
Socket Adaptor 3/4" (Internal) X 1/2" (External)	203	Semi Deep Thin Walled Impact Sockets, 3/8", 6pt 10-21mm	216
Socket Adaptor 1/2" (Internal) X 3/4" (External)	203	Socket Set; Impact, Deep and Shallow, 1/4"	216
6-Piece Adaptor Set	203	Socket Set; Deep, Impact, 3/4", 6pt, 22-50 mm	216
2-Piece Uni-Adaptors	203	Socket Set; Deep, Impact, 6pt, 22-50 mm, 10pcs	216
Lok-Reach™ Extension Bar 1/4 - 3/8 dr	204	Replacement Head For 4207-WW	217
5-Piece 1/4" Drive Wobble Extension Bar Set	204	Breaker Bar Head; 1/2"	217
5-Piece 3/8" Drive Wobble Extension Bar Set	204	Breaker Bar; Non Slip Handle and Oil Resistant, 24", 1/2"	218
5-Piece 1/2" Drive Wobble Extension Bar Set	204	Breaker Bar; 24", 1/2"	218
9-Piece 1/2 , 3/8 , 1/4" Drive Wobble Extension Bar Set	205	Breaker Bar; 39", 1"	218
9-Piece 1/2 , 3/8 , 1/4" Drive Wobble Extension Bar Set	205	Breaker Bar; 39", 3/4"	218
Wobble Extension Bar Set 9-piece 1/4, 3/8 & 1/2 Drive	205	Ratchet Set; Composite, 1/2", 3/8", 1/4"	219
Wobble Extension Bar Set 9-piece 1/4 , 3/8 & 1/2 Drive Magnetic Version	205	Ratchet Set; Telescopic	219
3-Piece Extra Long Extension Bar Set 3/8dr 375-450-600 mm	206	Ratchet Set; Telescopic with Flexi-Head, 1/2", 3/8", 1/4"	219
3-Piece Extra Long Extension Bar Set 1/2dr 450-600-750 mm	206	Ratchet Set; Telescopic with Flexi-Head and Lock, 1/2", 3/8", 1/4"	219
Extension Bar 1/4" dr 50mm	206	Ratchet Set; Extra Long, Fixed Head, 1/2", 3/8", 1/4"	220
Extension Bar 1/4" dr 100mm	206	Ratchet Set; Stubby, 1/2", 3/8", 1/4"	220
Extension Bar 1/4" dr 250mm	207	Ratchet Set; Classic, 1/2", 3/8", 1/4"	220
Extension Bar 3/8" dr 75mm	207	Ratchet Set; Extra Long, Flexi-Head, 1/2", 3/8", 1/4"	220
Extension Bar 3/8" dr 150mm	207	Replacement Button	221
Extension Bar 3/8" dr 250 mm	207	Repair Kit For 11120-WW	221
Extension Bar 1/2" dr 50mm	208	Ratchet Repair Kit For 1102-11102-11122-11111-11108-WW 1/4dr	221
Extension Bar 1/2" dr 125mm	208	3/4"Dr Telescopic Ratchet	221
Extension Bar 1/2" dr 250mm	208	108-Tooth Soft Grip Handle Ratchet 3-Piece Set	222
Impact Reducer 3/4"-1/2"dr Replaceable Head	209	Reversible Ratchet Ultra Thin 3-Piece Set	222
3-Piece Mini Impact Adaptor Set 1/4X36, 3/8X1/2, 1/2X3/4,	209	Socket Tool Set; 38-Piece Deep & Shallow, Chrome 6-point 3/8" (FP Series)	223
Adapter Set; Impact, 1/4"-1"	209	Socket Tool Set; 27-Piece Deep & Shallow, Chrome 6-point 1/4" (FP Series)	223
Ball Joint; Impact, 1/4"	210	Socket Tool Set; 20-Piece Shallow, Chrome 6-point 1/4" (FP Series)	223
Ball Joint; Impact, 3/8"	210	Socket Tool Set; 23-Piece Shallow, Chrome 6-point 3/8" (FP Series)	223
Ball Joint; Impact, 1/2"	210	1/2 dr Lok-Typ Sockets Shallow 8-32 MM	224
Impact Wrench Adaptor, 1/4" int. - 3/8" ext	210	1/2dr Multilock Sockets 8-32 mm	224
Impact Wrench Adaptor, 3/8" int. - 1/4" ext	211	Socket Set; Shallow, 1/2"	225
Impact Wrench Adaptor, 3/8" int. - 1/2" ext	211	Socket Set; Deep, 1/2"	225
Impact Wrench Adaptor, 1/2" int. - 3/8" ext	211		
Impact-Adaptor, 1/2" int. - 3/4" ext	211		
Impact-Adaptor, 3/4" int. - 1/2" ext	212		

Socket Set; Gearlock, Shallow, 1/2"	225
Socket Set; Gearlock, Deep, 1/2"	225
15-Piece Lok-TYP Shallow Sockets 3/8dr 8-22mm	226
12-Piece Lok-Typ Sockets Deep 3/8dr 8-19mm	226
Socket Set, Shallow, 3/8"	226
Socket Set; Deep, 3/8"	226
Socket Set; Gearlock, Shallow, 3/8"	227
Socket Set; Gearlock, Deep, 3/8"	227
1/4" dr Lok-Typ Sockets Deep 4-13 MM	227
1/4" dr Lok-Typ Sockets Shallow 4-13 MM	227
Socket Set; Shallow, 1/4"	228
Socket Set; Deep, 1/4"	228
Socket Set; Gearlock, Shallow, 1/4"	228
Socket Set; Gearlock, Deep, 1/4"	228
Socket Tool Set; 12pt, 19-50 mm, 3/4"	229
Socket Tool Set; 6pt, 19-50 mm, 3/4"	229
Socket Tool Set; 12pt, 19-50 mm, 3/4"	229
Socket Tool Set; 6Pt, 36-80mm, 1"	229
Socket Tool Set; 12Pt, 36-80mm, 1"	230
Socket Tool Set; 6Pt, 36-80mm, 1"	230
Socket Tool Set; Deep and Shallow, 1/4"	230
Socket Tool Set with Bits; 1/4"	230
Socket Tool Set; 1/2"	231
Socket Tool Set; Chrome, 1/4", 3/8", 1/2" (191 pcs)	231
Socket Tool Set; Gearlock Sockets, 1/4", 3/8", 1/2"	231
Socket Tool Set; Satin, 1/4", 3/8", 1/2" (191 pcs)	232
Socket Set; Go-Through, 1/4", 3/8", 1/2"	232
Socket Tool Set; Satin, 1/4", 3/8", 1/2" (216 pcs)	232
Socket Tool Set; 1/4" & 1/2" 95-Piece	233
Socket Tool Set; 1/2" (Imperial Sizes)	233
Socket Tool Set; 3/8"	233
Socket Tool Set; Deep and Shallow, Chrome, 1/4"	234
Protective Impact Sockets 17, 19, 21 mm	235
6 Piece 1/2 dr. Socket Set 15	235
17-mm Impact Socket + Plastic Protector For Mercedes-Benz Models	236
21-mm Impact Socket + Plastic Protector For Mercedes-Benz Models	236
Locking Wheel Nut Keys, Master Kit for VAG; 65pcs	236
Locking Wheel Nut Keys, Master Kit for BMW; 42pcs	236
Protective Impact Socket; Heavy Duty, 17 mm	237
Protective Impact Socket; Heavy Duty, 19 mm	237
Protective Impact Socket; Heavy Duty, 21 mm	237
Protective Impact Socket Set; Heavy Duty, 17, 19, 21 mm	237
Torsion Socket; 110mm Long, 17mm, 1/2"	238
Torsion Socket; 110mm Long, 19mm, 1/2"	238
Torsion Socket; 110mm Long, 21mm, 1/2"	238
Torsion Socket Set; 110mm, 17, 19, 21mm, 1/2"	238
Protective Impact Socket; Long, 17 mm, 1/2"	239
Protective Impact Socket; Long, 19 mm, 1/2"	239
Protective Impact Socket; Long, 21 mm, 1/2"	239
Protective Impact Socket Set; Long, 17, 19, 21 mm, 1/2"	239
Locking Wheel Nut Removers	240

Locking Wheel Nut Keys; VAG, 23 pcs	240
Locking Wheel Nut Keys; BMW, 21 pcs	240
Locking Wheel Nut Keys; VAG, 10 pcs	240
Locking Wheel Nut Keys; VAG, 10 pcs	241
Locking Wheel Nut Keys, BMW; OEM	241
Locking Wheel Nut Removal Kit; Universal (Large Sizes)	241
Locking Wheel Nut Removal Kit; Universal	241
Locking Wheel Nut Master Key Set; 16pcs	242
Locking Wheel Nut Keys, VAG; OEM	242
Locking Wheel Nut Keys, VAG; OEM	242
Locking Wheel Nut Keys, Mercedes; OEM, 12pcs	242
Locking Wheel Nut Removers	243
Locking Wheel Nut Key Set for Porsche, 20 Piece	243
Locking Wheel Nut Key Set for Audi, 20 Piece	243
Locking Wheel Nut Keys; BMW/MINI, 10 pcs	243
Locking Wheel Nut Removal Sockets	244
Locking Wheel Nut Keys, Volvo; B-Type, 20 pcs	244
Locking Wheel Nut Keys, Opel/Vauxhall; OEM, 12pcs	244
Locking Wheel Nut Keys, Land Rover; OEM, 10pcs	244
Locking Wheel Nut Removal Kit; Universal, 26.0-31.8	245
Locking Wheel Nut Removal Kit; Universal (Vibration Edition)	245
Hex Driver from 1158-WW; 22mm.	245
Hex Driver from 1158-WW, 17mm.	245
3-Piece Drive Shaft Splines M8 M10 M12	246
Drive Shaft Socket Set 30, 32, 36 mm	246
Hub Nut Socket for Ford Transit 2014 onward; Rear	246
Drive Shaft Sockets; 12pt, 24, 30, 32, 36, 46mm	246
Drive Shaft Socket; 12pt, 46mm	247
Hub Nut Socket for Ford Transit; 12pt, 56 mm	247
Hub Nut Socket for Ford Transit; 12pt, 65 mm	247
Hub Nut Socket for Ford Transit; 12pt, 50 mm	247
Glow Plug Sockets; Universal Joint, 3/8"	248
Mercedes Diesel Injection Socket 33-Toothed	248
Oxygen Sensor Socket; 22 mm (7/8") x 50 mm; 1/2" drive	248
7-Piece Oxygen Sensor Sockets	248
Tap Socket Set; 8pcs	249
PSG Glow Plug Insert Socket Set 6pcs	249
Spreader Socket Set for Spring Strut Clamp, 5 x 7 mm and 5.5 x 8.2 mm	249
Socket Set for use with Air Hammer (Vibration Impact)	249
Impact Vibration Glow Plug Removal Gun Incl Sockets 8-12 mm	250
Flexible Socket For Suspension Bolts On VAG Group	250
Socket For Porsche, Audi Q7 Brake Calipers; 10-PT	250
Common Rail Diesel Injector Repair Sockets	250
Specialist Automotive Sockets 10-Piece	251
Thin Walled Lambda Sensor Socket 22mm - Ford	251
Socket for DPF Sensors On Landrovers Models	251
Exhaust Gas Temperature Sensor Sockets 6-Piece Kit	251

Porsche 911 Carrera 4 GTS Socket for Center Wheel Lock Nut	252
11-Piece 3/8" Anti Skid Socket Set	252
1/4dr Long Twisty Sockets	252
Twist Sockets 27, 30, 32, 33, 34, 36mm, 3/4"	252
Twist Socket Set; 3/8", 10-19 mm	253
17-Piece Screw And Stud Extractor Set	253
8-Piece Universal Impact Adaptor Set + Universal Joints	253
Twist Sockets; Extra Long, 17, 19, 21 mm, 1/2"	253
Twist Socket Set; Long, 17, 19, 21, 22 mm, 1/2"	254
Extractor Set for Screws (25 pcs)	254
8-Piece Lok-Typ Torx Removers	254
Twist Sockets; 9-19mm, 3/8"	254
10-Piece Screw Extractor Set 3-11mm	255
Universal Stud Extractor 6-12 MM	255
5-Piece Oil Filter Tool Sockets	255
5-Piece Low Profile Oil Filter Sockets	255
14 mm Spark Plug Socket; 12-point; 3/8"; Length 90 mm With Magnet	256
Spark Plug Socket 14MM With Retaining Ring	256
Spark Plug Socket 14mm	256
Impact Power Hand Impact Wrench	256
Socket and Bit Master Set; Torx®, S2 Steel	257
Bit Socket Set; Torx Set® T6-T70 110mm Length S2 Zinc Steel	257
Bit Socket Set; Master Hex Bit Set 110 mm Length S2 Zinc Steel	257
Bit Socket Set; Master Spline Bit Set 110 mm Length	258
Bit Socket Set; Master Ribe Set 110 mm Length	258
Bit Socket Master Set; 17pcs	258
Bit Socket Master Set; Spline, 12pcs	258
Socket Set, Torx Bits®, S2 Steel, T6-T70	259
Socket Set, Torx® Plus Bits, S2 Steel, 8IP-60IP	259
12-piece Tamper Torx Set T8H-T60H S2 Zinc Steel	259
Socket Set, Torx®; 3/8", E4-E24, S2 Steel	259
Bit Socket Set; 3/8dr Torx Set 48mm T20-T45	260
Hex Key Set; 48 mm, H3-H10	260
Bit Socket Set; 3/8dr Ball Allan Key Set 48mm HB3-HB10	260
Bit Master Set; 81 pcs (S2 Steel)	260
Bit Socket Set; 3/8dr Extra Long Torx Set 110mm T20-T45	261
Bit Socket Set; 3/8dr Extra Long Allan Key Set 110mm H3-H10	261
Bit Socket Set; 3/8dr Extra Long Ball Allan Key Set 110mm HB3-HB10	261
Bit Socket Set; 3/8dr Extra Long Spline Set 110mm M4-M10	261
Bit Socket Set; Extra Long Torx, Hexagon, Ball-Ended Hexagon 110mm	261
Torque Wrench 1/2"Dr 40-200NM Digital With Angle Settings	263
Torque Wrench 1/2"Dr 68-340NM Digital With Angle Settings	263
Torque Wrench 3/8"Dr 20-100NM Digital With Angle Settings	263
Torque Wrench 3/8"Dr 27-135NM Digital With Angle Settings	263

Crowfoot Spanner Set; 1/2", 20-32mm	264
Crowfoot Spanner Set; 1/2", 10-19 mm	264
Universal Extender Wrench Tool; XL	264
Universal Extender Wrench Tool	264
Ratchet Spanner Set; E-Torx Profile	265
Line Spanners; Offset	265
Spanners for Poly-V-Belts	265
Fuel Tank Sender Unit Spanner Set	265
E-Profile Poly-V-Belt Spanners	266
Ratchet Brake Pipe Spanners	266
Spanner Set; Aviation Type, Double Ring, 8-24 mm (Master Set)	266
Spanner Set; Aviation Type with Multi-spline Profile	266
Combination Spanner Set; Jumbo, 34-50 mm	267
Spanner Set; Aviation Type, Double Ring, 8-24 mm	267
Double Ring Spanners for E-Type Screws (external), E6xE8-E20xE24	267
12-Piece Fast Action Wrenches 8-21 mm	267
Combination Spanner Set; 8-19 mm	268
Combination Spanner Set; 6-32 mm	268
10-Piece Stubby Spanner Set 8-19 mm	268
Ratchet Spanner Set; Ring & Ratchet, 8-19 mm	268
Ratchet Spanner Set; Double Flexi-Head, 8-19 mm	269
Ratchet Spanner Set; 8-19 mm	269
Ratchet Spanner Set; with Flexi-Head, 8-19 mm	269
Ratchet Spanner Set; Fixed-Head, Stubby, 8-19 mm	269
Ratchet Spanner Set; Flexi-Head, Stubby, 8-19 mm	270
Ratchet Spanner Set; XL, 8-32 mm	270
Ratchet Spanner Set; Reversible Switch, 8-24 mm	270
Ratchet Spanner Set; Aviation Type, Flexi-Head 8-19 mm	270
1/4" Bit Socket, T6, 37mm	272
3/8" Bit Socket, T45, 48mm	272
3/8" Bit Socket, T47, 48mm	272
3/8" Bit Socket, T50, 48mm	272
3/8" Bit Socket, T55, 48mm	272
1/2" Bit Socket, T60, 55mm	272
1/2" Bit Socket, T70, 55mm	272
1/4" Bit Socket, T8, 37mm	272
1/4" Bit Socket, T10, 37mm	272
1/4" Bit Socket, T15, 37mm	272
1/4" Bit Socket, T20, 37mm	272
1/4" Bit Socket, T25, 37mm	272
1/4" Bit Socket, T27, 37mm	272
1/4" Bit Socket, T30, 37mm	272
3/8" Bit Socket, T40, 48mm	272
1/4" Bit Socket, 8IP, 37mm	272
3/8" Bit Socket, 50IP, 48mm	272
3/8" Bit Socket, 55IP, 48mm	272
1/2" Bit Socket, 60IP, 55mm	272
1/4" Bit Socket, 10IP, 37mm	272
1/4" Bit Socket, 15IP, 37mm	272
1/4" Bit Socket, 20IP, 37mm	272
1/4" Bit Socket, 25IP, 37mm	272
1/4" Bit Socket, 27IP, 37mm	272

1/4" Bit Socket, 30IP, 37mm	272
3/8" Bit Socket, 40IP, 48mm	272
3/8" Bit Socket, 45IP, 48mm	272
1/4" Bit Socket, T8H, 37mm	272
3/8" Bit Socket, T50H, 48mm	272
3/8" Bit Socket, T55H, 48mm	272
1/2" Bit Socket, T60H, 55mm	272
1/4" Bit Socket, T10H, 37mm	272
1/4" Bit Socket, T15H, 37mm	272
1/4" Bit Socket, T20H, 37mm	272
1/4" Bit Socket, T25H, 37mm	272
1/4" Bit Socket, T27H, 37mm	272
1/4" Bit Socket, T30H, 37mm	272
3/8" Bit Socket, T40H, 48mm	272
3/8" Bit Socket, T45H, 48mm	272
Bit Socket; H10, 3/8"	272
Bit Socket; H12, 3/8"	272
Bit Socket; H14, 1/2"	272
Bit Socket; H15, 1/2"	272
Bit Socket; H17, 1/2"	272
Bit Socket; H19, 1/2"	272
Bit Socket; H2, 1/4"	272
Bit Socket; H2.5, 1/4"	272
Bit Socket; H22, 1/2"	272
Bit Socket; H3, 1/4"	272
Bit Socket; H4, 1/4"	272
Bit Socket; H5, 1/4"	272
Bit Socket; H5.5, 1/4"	272
Bit Socket; H6, 1/4"	272
Bit Socket; H7, 1/4"	272
Bit Socket; H8, 1/4"	272
Bit Socket; H9, 1/4"	272
Bit Socket; M10, 3/8"	272
Bit Socket; M12, 3/8"	272
Bit Socket; M13, 1/2"	272
Bit Socket; M14, 1/2"	272
Bit Socket; M16, 1/2"	272
Bit Socket; M18, 1/2"	272
Bit Socket; M4, 1/4"	273
Bit Socket; M5, 1/4"	273
Bit Socket; M6, 1/4"	273
Bit Socket; M7, 1/4"	273
Bit Socket; M8, 3/8"	273
Bit Socket; M9, 3/8"	273
Bit Socket; Torx, T30	273
Bit Socket; Torx, T40	273
Bit Socket; Torx, T45	273
Bit Socket; Torx, T50	273
Bit Socket; Torx, T55	273
Bit Socket; Torx, T60	273
Bit Socket; Torx, T70	273
Bit Socket; Torx, T80	273
Bit Socket; Impact, M10	273
Bit Socket; Impact, M12	273

Bit Socket; Impact, M14	273
Bit Socket; Impact, M16	273
Bit Socket; Impact, M18	273
Bit Socket; Impact, M5	273
Bit Socket; Impact, M6	273
Bit Socket; Impact, M8	273
Bit Socket; Impact, 6pt, H10	273
Bit Socket; Impact, 6pt, H12	273
Bit Socket; Impact, 6pt, H14	273
Bit Socket; Impact, 6pt, H17	273
Bit Socket; Impact, 6pt, H19	273
Bit Socket; Impact, 6pt, H5	273
Bit Socket; Impact, 6pt, H6	273
Bit Socket; Impact, 6pt, H8	273
Bit Socket; Impact, 6pt, H19	273
Bit Socket; Low Profile, Impact, M10	273
Bit Socket; Low Profile, Impact, M12	273
Bit Socket; Low Profile, Impact, M14	273
Bit Socket; Low Profile, Impact, M16	273
Bit Socket; Low Profile, Impact, M18	273
Bit Socket; Low Profile, Impact, M4	273
Bit Socket; Low Profile, Impact, M5	273
Bit Socket; Low Profile, Impact, M6	273
Bit Socket; Low Profile, Impact, M8	273
Bit Socket; Low Profile, Impact, T10	273
Bit Socket; Low Profile, Impact, T15	273
Bit Socket; Low Profile, Impact, T20	273
Bit Socket; Low Profile, Impact, T25	273
Bit Socket; Low Profile, Impact, T27	273
Bit Socket; Low Profile, Impact, T30	273
Bit Socket; Low Profile, Impact, T40	273
Bit Socket; Low Profile, Impact, T45	273
Bit Socket; Low Profile, Impact, T47	273
Bit Socket; Low Profile, Impact, T50	273
Bit Socket M10 200MM Length; 1/2dr Spline	273
Bit Socket M10 100MM Length; 1/2dr Spline	273
Bit Socket M10 140MM Length; 1/2dr Spline	273
Bit Socket M10 55MM Length; 1/2dr Spline	273
Bit Socket M12 100MM Length; 1/2dr Spline	273
Bit Socket M12 140MM Length; 1/2dr Spline	273
Bit Socket M12 200MM Length; 1/2dr Spline	273
Bit Socket M12 55MM Length; 1/2dr Spline	273
Bit Socket M14 100MM Length; 1/2dr Spline	273
Bit Socket M14 140MM Length; 1/2dr Spline	273
Bit Socket M14 200MM Length; 1/2dr Spline	273
Bit Socket M14 55MM Length; 1/2dr Spline	273
Bit Socket M16 55MM Length; 1/2dr Spline	273
Bit Socket M5 100MM Length; 1/2dr Spline	273
Bit Socket M5 140MM Length; 1/2dr Spline	273
Bit Socket M5 55MM Length; 1/2dr Spline	274
Bit Socket M6 100MM Length; 1/2dr Spline	274
Bit Socket M6 140MM Length; 1/2dr Spline	274
Bit Socket M6 55MM Length; 1/2dr Spline	274
Bit Socket M8 100MM Length; 1/2dr Spline	274

Bit Socket M8 140MM Length; 1/2dr Spline	274
Bit Socket M8 200MM Length; 1/2dr Spline	274
Bit Socket M8 55MM Length; 1/2dr Spline	274
Bit Socket M9 100MM Length; 1/2dr Spline	274
Bit Socket M9 140MM Length; 1/2dr Spline	274
Bit Socket M9 55MM Length; 1/2dr Spline	274
Bit Socket T20 100mm Length; 1/2dr T-Star	274
Bit Socket T20 55mm Length; 1/2dr T-Star	274
Bit Socket T25 100mm Length; 1/2dr T-Star	274
Bit Socket T25 55mm Length; 1/2dr T-Star	274
Bit Socket T27 100mm Length; 1/2dr T-Star	274
Bit Socket T27 55mm Length; 1/2dr T-Star	274
Bit Socket T30 100mm Length; 1/2dr T-Star	274
Bit Socket T30 55mm Length; 1/2dr T-Star	274
Bit Socket T40 100mm Length; 1/2dr T-Star	274
Bit Socket T40 140mm Length; 1/2dr T-Star	274
Bit Socket T40 200mm Length; 1/2dr T-Star	274
Bit Socket T40 55mm Length; 1/2dr T-Star	274
Bit Socket T45 100mm Length; 1/2dr T-Star	274
Bit Socket T45 140mm Length; 1/2dr T-Star	274
Bit Socket T45 200mm Length; 1/2dr T-Star	274
Bit Socket T45 55mm Length; 1/2dr T-Star	274
Bit Socket T50 100mm Length; 1/2dr T-Star	274
Bit Socket T50 140mm Length; 1/2dr T-Star	274
Bit Socket T50 200mm Length; 1/2dr T-Star	274
Bit Socket T50 55mm Length; 1/2dr T-Star	274
Bit Socket T55 100mm Length; 1/2dr T-Star	274
Bit Socket T55 140mm Length; 1/2dr T-Star	274
Bit Socket T55 200mm Length; 1/2dr T-Star	274
Bit Socket T55 55mm Length; 1/2dr T-Star	274
Bit Socket T60 100mm Length; 1/2dr T-Star	274
Bit Socket T60 140mm Length; 1/2dr T-Star	274
Bit Socket T60 200mm Length; 1/2dr T-Star	274
Bit Socket T60 55mm Length; 1/2dr T-Star	274
Bit Socket T70 100mm Length; 1/2dr T-Star	274
Bit Socket T70 140mm Length; 1/2dr T-Star	274
Bit Socket T70 200mm Length; 1/2dr T-Star	274
Bit Socket T70 55mm Length; 1/2dr T-Star	274
Bit Socket; 3/8dr Extra Long Allan Key 110mm H10	274
Bit Socket; 3/8dr Extra Long Allan Key 110mm H3	274
Bit Socket; 3/8dr Extra Long Allan Key 110mm H4	274
Bit Socket; 3/8dr Extra Long Allan Key 110mm H5	274
Bit Socket; 3/8dr Extra Long Allan Key 110mm H6	274
Bit Socket; 3/8dr Extra Long Allan Key 110mm H7	274
Bit Socket; 3/8dr Extra Long Allan Key 110mm H8	274
Bit Socket; 3/8dr Extra Long Allan Key 110mm H9	274
Bit Socket; Spline, 110mm, 3/8", M10	274
Bit Socket; Spline, 110mm, 3/8", M4	274
Bit Socket; Spline, 110mm, 3/8", M5	274
Bit Socket; Spline, 110mm, 3/8", M6	274
Bit Socket; Spline, 110mm, 3/8", M7	274
Bit Socket; Spline, 110mm, 3/8", M8	274
Bit Socket; Spline, 110mm, 3/8", M9	274
Bit Socket; 3/8dr Extra Long Torx 110mm T20	274

Bit Socket; 3/8dr Extra Long Torx 110mm T25	274
Bit Socket; 3/8dr Extra Long Torx 110mm T27	274
Bit Socket; 3/8dr Extra Long Torx 110mm T30	274
Bit Socket; 3/8dr Extra Long Torx 110mm T40	274
Bit Socket; 3/8dr Extra Long Torx 110mm T45	274
Bit Socket; Torx®, 1/4", 110mm, T8	275
Bit Socket; Torx®, 1/4", 110mm, T10	275
Bit Socket; Torx®, 1/4", 110mm, T15	275
Bit Socket; Torx®, 1/4", 110mm, T20	275
Bit Socket; Torx®, 1/4", 110mm, T25	275
Bit Socket; Torx®, 1/4", 110mm, T27	275
Bit Socket; Torx®, 1/4", 110mm, T30	275
Bit Socket; Torx®, 3/8", 110mm, T40	275
Bit Socket; Torx®, 3/8", 110mm, T45	275
Bit Socket; Torx®, 3/8", 110mm, T47	275
Bit Socket; Torx®, 3/8", 110mm, T50	275
Bit Socket; Torx®, 3/8", 110mm, T55	275
Bit Socket; Torx®, 1/4", 110mm, T6	275
Bit Socket; Torx®, 1/2", 110mm, T60	275
Bit Socket; Torx®, 1/2", 110mm, T70	275
Bit Socket; Hex, 3/8", 110mm, 10 mm	275
Bit Socket; Hex, 3/8", 110mm, 12 mm	275
Bit Socket; Hex, 1/2", 110mm, 14 mm	275
Bit Socket; Hex, 1/2", 110mm, 15 mm	275
Bit Socket; Hex, 1/2", 110mm, 17 mm	275
Bit Socket; Hex, 1/2", 110mm, 19 mm	275
Bit Socket; Hex, 1/4", 110mm, 2 mm	275
Bit Socket; Hex, 1/4", 110mm, 2.5 mm	275
Bit Socket; Hex, 1/2", 110mm, 22 mm	275
Bit Socket; Hex, 1/4", 110mm, 3 mm	275
Bit Socket; Hex, 1/4", 110mm, 4 mm	275
Bit Socket; Hex, 1/4", 110mm, 5 mm	275
Bit Socket; Hex, 1/4", 110mm, 5.5 mm	275
Bit Socket; Hex, 1/4", 110mm, 6 mm	275
Bit Socket; Hex, 3/8", 110mm, 7 mm	275
Bit Socket; Hex, 3/8", 110mm, 8 mm	275
Bit Socket; Hex, 3/8", 110mm, 9 mm	275
Bit Socket; Spline, 110 mm, 3/8", M10	275
Bit Socket; Spline, 110 mm, 1/2", M12	275
Bit Socket; Spline, 110 mm, 1/2", M13	275
Bit Socket; Spline, 110 mm, 1/2", M14	275
Bit Socket; Spline, 110 mm, 1/2", M16	275
Bit Socket; Spline, 110 mm, 1/2", M18	275
Bit Socket; Spline, 110 mm, 1/4", M4	275
Bit Socket; Spline, 110 mm, 1/4", M5	275
Bit Socket; Spline, 110 mm, 1/4", M6	275
Bit Socket; Spline, 110 mm, 3/8", M7	275
Bit Socket; Spline, 110 mm, 3/8", M8	275
Bit Socket; Spline, 110 mm, 3/8", M9	275
Bit Socket; 3/8dr Torx 48mm T20	275
Bit Socket; 3/8dr Torx 48mm T25	275
Bit Socket; 3/8dr Torx 48mm T27	275
Bit Socket; 3/8dr Torx 48mm T30	275
Bit Socket; 3/8dr Torx 48mm T40	275

Bit Socket; 3/8dr Torx 48mm T45	275
Bit Socket; Allan Key, 48 mm, 3/8", H10	275
Bit Socket; Allan Key, 48 mm, 3/8", H3	275
Bit Socket; Allan Key, 48 mm, 3/8", H4	275
Bit Socket; Allan Key, 48 mm, 3/8", H5	275
Bit Socket; Allan Key, 48 mm, 3/8", H6	275
Bit Socket; Allan Key, 48 mm, 3/8", H7	275
Bit Socket; Allan Key, 48 mm, 3/8", H8	275
Bit Socket; Allan Key with Ball End, 48 mm, 3/8" H10	275
Bit Socket; Allan Key with Ball End, 48 mm, 3/8", H3	275
Bit Socket; Allan Key with Ball End, 48 mm, 3/8", H4	275
Bit Socket; Allan Key with Ball End, 48 mm, 3/8", H5	275
Bit Socket; Allan Key with Ball End, 48 mm, 3/8", H6	275
Bit Socket; Allan Key with Ball End, 48 mm, 3/8", H7	275
Bit Socket; Allan Key with Ball End, 48 mm, 3/8", H8	275
1/2" Drive Lok-Typ Shallow Socket 8 mm	276
1/2" Drive Lok-Typ Shallow Socket 17 mm	276
1/2" Drive Lok-Typ Shallow Socket 18 mm	276
1/2" Drive Lok-Typ Shallow Socket 19 mm	276
1/2" Drive Lok-Typ Shallow Socket 20 mm	276
1/2" Drive Lok-Typ Shallow Socket 21 mm	276
1/2" Drive Lok-Typ Shallow Socket 22 mm	276
1/2" Drive Lok-Typ Shallow Socket 23 mm	276
1/2" Drive Lok-Typ Shallow Socket 24 mm	276
1/2" Drive Lok-Typ Shallow Socket 27 mm	276
1/2" Drive Lok-Typ Shallow Socket 30 mm	276
1/2" Drive Lok-Typ Shallow Socket 9 mm	276
1/2" Drive Lok-Typ Shallow Socket 32 mm	276
1/2" Drive Lok-Typ Shallow Socket 10 mm	276
1/2" Drive Lok-Typ Shallow Socket 11 mm	276
1/2" Drive Lok-Typ Shallow Socket 12 mm	276
1/2" Drive Lok-Typ Shallow Socket 13 mm	276
1/2" Drive Lok-Typ Shallow Socket 14 mm	276
1/2" Drive Lok-Typ Shallow Socket 15 mm	276
1/2" Drive Lok-Typ Shallow Socket 16 mm	276
Socket; 1/2", 10 mm	276
Socket; 1/2", 11 mm	276
Socket; 1/2", 12 mm	276
Socket; 1/2", 13 mm	276
Socket; 1/2", 14 mm	276
Socket; 1/2", 15 mm	276
Socket; 1/2", 16 mm	276
Socket; 1/2", 17 mm	276
Socket; 1/2", 18 mm	276
Socket; 1/2", 19 mm	276
Socket; 1/2", 20 mm	276
Socket; 1/2", 21 mm	276
Socket; 1/2", 22 mm	276
Socket; 1/2", 24 mm	276
Socket; 1/2", 27 mm	276
Socket; 1/2", 30 mm	276
Socket; 1/2", 32 mm	276
3/8" Drive Lok-Typ Socket 8 mm	276
3/8" Drive Lok-Typ Socket 17 mm	276

3/8" Drive Lok-Typ Socket 18 mm	276
3/8" Drive Lok-Typ Socket 19 mm	276
3/8" Drive Lok-Typ Socket 20 mm	276
3/8" Drive Lok-Typ Socket 21 mm	276
3/8" Drive Lok-Typ Socket 22 mm	276
3/8" Drive Lok-Typ Socket 9 mm	276
3/8" Drive Lok-Typ Socket 10 mm	276
3/8" Drive Lok-Typ Socket 11 mm	276
3/8" Drive Lok-Typ Socket 12 mm	276
3/8" Drive Lok-Typ Socket 13 mm	276
3/8" Drive Lok-Typ Socket 14 mm	276
3/8" Drive Lok-Typ Socket 15 mm	276
3/8" Drive Lok-Typ Socket 16 mm	276
3/8" Drive Lok-Typ Socket, Deep, 8 mm	276
3/8" Drive Lok-Typ Socket, Deep, 17 mm	276
3/8" Drive Lok-Typ Socket, Deep, 18 mm	276
3/8" Drive Lok-Typ Socket, Deep, 19 mm	276
3/8" Drive Lok-Typ Socket, Deep, 9 mm	276
3/8" Drive Lok-Typ Socket, Deep, 10 mm	276
3/8" Drive Lok-Typ Socket, Deep, 11 mm	276
3/8" Drive Lok-Typ Socket, Deep, 12 mm	276
3/8" Drive Lok-Typ Socket, Deep, 13 mm	276
3/8" Drive Lok-Typ Socket, Deep, 14 mm	276
3/8" Drive Lok-Typ Socket, Deep, 15 mm	276
3/8" Drive Lok-Typ Socket, Deep, 16 mm	276
Socket; 3/8", 10 mm	277
Socket; 3/8", 11 mm	277
Socket; 3/8", 12 mm	277
Socket; 3/8", 13 mm	277
Socket; 3/8", 14 mm	277
Socket; 3/8", 15 mm	277
Socket; 3/8", 16 mm	277
Socket; 3/8", 17 mm	277
Socket; 3/8", 18 mm	277
Socket; 3/8", 19 mm	277
Socket; 3/8", 20 mm	277
Socket; 3/8", 21 mm	277
Socket; 3/8", 22 mm	277
Socket; 3/8", 23 mm	277
Socket; 3/8", 24 mm	277
Socket; 3/8", 8 mm	277
Socket; 3/8", 9 mm	277
Socket; Deep, 3/8", 8 mm	277
Socket; Deep, 3/8", 9 mm	277
Socket; Deep, 3/8", 10 mm	277
Socket; Deep, 3/8", 11 mm	277
Socket; Deep, 3/8", 12 mm	277
Socket; Deep, 3/8", 13 mm	277
Socket; Deep, 3/8", 14 mm	277
Socket; Deep, 3/8", 15 mm	277
Socket; Deep, 3/8", 16 mm	277
Socket; Deep, 3/8", 17 mm	277
Socket; Deep, 3/8", 18 mm	277
Socket; Deep, 3/8", 19 mm	277

Socket; Deep, 3/8", 20 mm	277
Socket; Deep, 3/8", 21 mm	277
4-MM 1/4 dr Lok-Typ Sockets Deep	277
5-MM 1/4 dr Lok-Typ Sockets Deep	277
5.5-MM 1/4 dr Lok-Typ Sockets Deep	277
6-MM 1/4 dr Lok-Typ Sockets Deep	277
7-MM 1/4 dr Lok-Typ Sockets Deep	277
8-MM 1/4 dr Lok-Typ Sockets Deep	277
9-MM 1/4 dr Lok-Typ Sockets Deep	277
10-MM 1/4 dr Lok-Typ Sockets Deep	277
11-MM 1/4 dr Lok-Typ Sockets Deep	277
12-MM 1/4 dr Lok-Typ Sockets Deep	277
4-MM 1/4 dr Lok-Typ Socket	277
5-MM 1/4 dr Lok-Typ Socket	277
5.5-MM 1/4 dr Lok-Typ Socket	277
6-MM 1/4 dr Lok-Typ Socket	277
7-MM 1/4 dr Lok-Typ Socket	277
8-MM 1/4 dr Lok-Typ Socket	277
9-MM 1/4 dr Lok-Typ Socket	277
10-MM 1/4 dr Lok-Typ Socket	277
11-MM 1/4 dr Lok-Typ Socket	277
12-MM 1/4 dr Lok-Typ Socket	277
13-MM 1/4 dr Lok-Typ Socket	277
1/4"dr Shallow Socket 4-mm	277
1/4"dr Shallow Socket 4.5-mm	277
1/4"dr Shallow Socket 5-mm	277
1/4"dr Shallow Socket 5.5-mm	277
1/4"dr Shallow Socket 6-mm	277
1/4"dr Shallow Socket 7-mm	277
1/4"dr Shallow Socket 8-mm	277
1/4"dr Shallow Socket 9-mm	277
1/4"dr Shallow Socket 10-mm	277
1/4"dr Shallow Socket 11-mm	277
1/4"dr Shallow Socket 12-mm	277
1/4"dr Shallow Socket 13-mm	277
1/4"dr Shallow Socket 14-mm	277
1/4"dr Deep Socket 4-mm	278
1/4"dr Deep Socket 4.5-mm	278
1/4"dr Deep Socket 5-mm	278
1/4"dr Deep Socket 5.5-mm	278
1/4"dr Deep Socket 6-mm	278
1/4"dr Deep Socket 7-mm	278
1/4"dr Deep Socket 8-mm	278
1/4"dr Deep Socket 9-mm	278
1/4"dr Deep Socket 10-mm	278
1/4"dr Deep Socket 11-mm	278
1/4"dr Deep Socket 12-mm	278
1/4"dr Deep Socket 13-mm	278
1/4"dr Deep Socket 14-mm	278
Protective Impact 1/2" with Plastic Coating; 17 mm	278
Protective Impact 1/2" with Plastic Coating; 19 mm	278
Protective Impact 1/2" with Plastic Coating; 21 mm	278
Socket; 1/2", 10 mm, Deep, Impact (Lok-Typ™)	278
Socket; 1/2", 11 mm, Deep, Impact (Lok-Typ™)	278

Socket; 1/2", 12 mm, Deep, Impact (Lok-Typ™)	278
Socket; 1/2", 13 mm, Deep, Impact (Lok-Typ™)	278
Socket; 1/2", 14 mm, Deep, Impact (Lok-Typ™)	278
Socket; 1/2", 15 mm, Deep, Impact (Lok-Typ™)	278
Socket; 1/2", 16 mm, Deep, Impact (Lok-Typ™)	278
Socket; 1/2", 17 mm, Deep, Impact (Lok-Typ™)	278
Socket; 1/2", 18 mm, Deep, Impact (Lok-Typ™)	278
Socket; 1/2", 19 mm, Deep, Impact (Lok-Typ™)	278
Socket; 1/2", 21 mm, Deep, Impact (Lok-Typ™)	278
Socket; 1/2", 22 mm, Deep, Impact (Lok-Typ™)	278
Socket; 1/2", 24 mm, Deep, Impact (Lok-Typ™)	278
Socket; 1/2", 27 mm, Deep, Impact (Lok-Typ™)	278
Socket; 1/2", 30 mm, Deep, Impact (Lok-Typ™)	278
Socket; 1/2", 32 mm, Deep, Impact (Lok-Typ™)	278
1/2" Female Socket, E18, 38mm	278
1/2" Female Socket, E20, 38mm	278
1/2" Female Socket, E22, 38mm	278
1/2" Female Socket, E24, 38mm	278
Socket; Impact, 6pt, Deep, 17 mm, 1/2"	278
Socket; Impact, 6pt, Deep, 19 mm, 1/2"	278
Socket; Impact, 6pt, Deep, 21 mm, 1/2"	278
Socket; Impact, 6pt, Deep, 24 mm, 1/2"	278
Socket; Impact, 6pt, Deep, 32 mm, 1/2"	278
Socket; 1/2 Deep Impact, 10 mm	278
Socket; 1/2 Deep Impact, 11 mm	278
Socket; 1/2 Deep Impact, 12 mm	278
Socket; 1/2 Deep Impact, 13 mm	278
Socket; 1/2 Deep Impact, 14 mm	278
Socket; 1/2 Deep Impact, 15 mm	278
Socket; 1/2 Deep Impact, 16 mm	278
Socket; 1/2 Deep Impact, 18 mm	278
Socket; 1/2 Deep Impact, 22 mm	278
Socket; 1/2 Deep Impact, 27 mm	278
Socket; 1/2 Deep Impact, 30 mm	278
Socket; Deep Impact, 1/2", 12pt, 10 mm	278
Socket; Deep Impact, 1/2", 12pt, 11 mm	278
Socket; Deep Impact, 1/2", 12pt, 12 mm	278
Socket; Deep Impact, 1/2", 12pt, 13 mm	278
Socket; Deep Impact, 1/2", 12pt, 14 mm	278
Socket; Deep Impact, 1/2", 12pt, 15 mm	278
Socket; Deep Impact, 1/2", 12pt, 16 mm	278
Socket; Deep Impact, 1/2", 12pt, 17 mm	278
Socket; Deep Impact, 1/2", 12pt, 18 mm	278
Socket; Deep Impact, 1/2", 12pt, 19 mm	278
Socket; Deep Impact, 1/2", 12pt, 21 mm	278
Socket; Deep Impact, 1/2", 12pt, 22 mm	278
Socket; Deep Impact, 1/2", 12pt, 24 mm	278
Socket; Deep Impact, 1/2", 12pt, 27 mm	279
Socket; Deep Impact, 1/2", 12pt, 30 mm	279
Socket; Deep Impact, 1/2", 12pt, 33 mm	279
Socket; Deep Impact, 1/2", 12pt, 34 mm	279
Socket; Deep Impact, 1/2", 12pt, 36 mm	279
Socket; Deep Impact, 1/2", 12pt, 38 mm	279
Socket; Extra Deep, Impact, 1/2" 10mm	279

Socket; Extra Deep, Impact, 1/2" 12mm	279
Socket; Extra Deep, Impact, 1/2" 13mm	279
Socket; Extra Deep, Impact, 1/2" 14mm	279
Socket; Extra Deep, Impact, 1/2" 15mm	279
Socket; Extra Deep, Impact, 1/2" 17mm	279
Socket; Extra Deep, Impact, 1/2" 18mm	279
Socket; Extra Deep, Impact, 1/2" 19mm	279
Socket; Extra Deep, Impact, 1/2" 21mm	279
Socket; Extra Deep, Impact, 1/2" 22mm	279
Socket; Extra Deep, Impact, 1/2" 24mm	279
Socket; Extra Deep, Impact, 1/2" 27mm	279
Socket; Extra Deep, Impact, 1/2" 30mm	279
Socket; Extra Deep, Impact, 1/2" 32mm	279
Socket; Shallow, Impact 1/2", Lok-Typ, 10 mm	279
Socket; Shallow, Impact 1/2", Lok-Typ, 11 mm	279
Socket; Shallow, Impact 1/2", Lok-Typ, 12 mm	279
Socket; Shallow, Impact 1/2", Lok-Typ, 13 mm	279
Socket; Shallow, Impact 1/2", Lok-Typ, 14 mm	279
Socket; Shallow, Impact 1/2", Lok-Typ, 15 mm	279
Socket; Shallow, Impact 1/2", Lok-Typ, 16 mm	279
Socket; Shallow, Impact 1/2", Lok-Typ, 17 mm	279
Socket; Shallow, Impact 1/2", Lok-Typ, 18 mm	279
Socket; Shallow, Impact 1/2", Lok-Typ, 19 mm	279
Socket; Shallow, Impact 1/2", Lok-Typ, 21 mm	279
Socket; Shallow, Impact 1/2", Lok-Typ, 22 mm	279
Socket; Shallow, Impact 1/2", Lok-Typ, 24 mm	279
Socket; Shallow, Impact 1/2", Lok-Typ, 27 mm	279
Socket; Shallow, Impact 1/2", Lok-Typ, 30 mm	279
Socket; Shallow, Impact 1/2", Lok-Typ, 32 mm	279
Semi Deep Impact Socket, 1/2", 6pt, 10mm	279
Semi Deep Impact Socket, 1/2", 6pt, 11mm	279
Semi Deep Impact Socket, 1/2", 6pt, 12mm	279
Semi Deep Impact Socket, 1/2", 6pt, 13mm	279
Semi Deep Impact Socket, 1/2", 6pt, 14mm	279
Semi Deep Impact Socket, 1/2", 6pt, 15mm	279
Semi Deep Impact Socket, 1/2", 6pt, 16mm	279
Semi Deep Impact Socket, 1/2", 6pt, 17mm	279
Semi Deep Impact Socket, 1/2", 6pt, 18mm	279
Semi Deep Impact Socket, 1/2", 6pt, 19mm	279
Semi Deep Impact Socket, 1/2", 6pt, 21mm	279
Semi Deep Impact Socket, 1/2", 6pt, 22mm	279
Semi Deep Impact Socket, 1/2", 6pt, 23mm	279
Semi Deep Impact Socket, 1/2", 6pt, 24mm	279
Semi Deep Impact Socket, 1/2", 6pt, 27mm	279
Semi Deep Impact Socket, 1/2", 6pt, 30mm	279
Semi Deep Impact Socket, 1/2", 6pt, 32mm	279
Socket; 3/8", 8 mm, Deep, Impact (Lok-Typ™)	279
Socket; 3/8", 9 mm, Deep, Impact (Lok-Typ™)	279
Socket; 3/8", 16 mm, Deep, Impact (Lok-Typ™)	279
Socket; 3/8", 17 mm, Deep, Impact (Lok-Typ™)	279
Socket; 3/8", 18 mm, Deep, Impact (Lok-Typ™)	279
Socket; 3/8", 19 mm, Deep, Impact (Lok-Typ™)	279
Socket; 3/8", 10 mm, Deep, Impact (Lok-Typ™)	279
Socket; 3/8", 11 mm, Deep, Impact (Lok-Typ™)	279

Socket; 3/8", 12 mm, Deep, Impact (Lok-Typ™)	279
Socket; 3/8", 13 mm, Deep, Impact (Lok-Typ™)	279
Socket; 3/8", 14 mm, Deep, Impact (Lok-Typ™)	279
Socket; 3/8", 15 mm, Deep, Impact (Lok-Typ™)	279
3/8" Female Socket, E10, 28mm	280
3/8" Female Socket, E12, 28mm	280
3/8" Female Socket, E14, 28mm	280
3/8" Female Socket, E16, 28mm	280
1/4" Female Socket, E4, 25mm	280
1/4" Female Socket, E5, 25mm	280
1/4" Female Socket, E6, 25mm	280
1/4" Female Socket, E7, 25mm	280
1/4" Female Socket, E8, 25mm	280
Semi Deep Impact Socket, 3/8", 6pt, 8mm	280
Semi Deep Impact Socket, 3/8", 6pt, 9mm	280
Semi Deep Impact Socket, 3/8", 6pt, 10mm	280
Semi Deep Impact Socket, 3/8", 6pt, 11mm	280
Semi Deep Impact Socket, 3/8", 6pt, 12mm	280
Semi Deep Impact Socket, 3/8", 6pt, 13mm	280
Semi Deep Impact Socket, 3/8", 6pt, 14mm	280
Semi Deep Impact Socket, 3/8", 6pt, 15mm	280
Semi Deep Impact Socket, 3/8", 6pt, 16mm	280
Semi Deep Impact Socket, 3/8", 6pt, 17mm	280
Semi Deep Impact Socket, 3/8", 6pt, 18mm	280
Semi Deep Impact Socket, 3/8", 6pt, 19mm	280
Semi Deep Impact Socket, 3/8", 6pt, 21mm	280
Semi Deep Impact Socket, 3/8", 6pt, 22mm	280
Locking Wheel Nut Remover 26	280
Locking Wheel Nut Remover 35.8	280
Locking Wheel Nut Remover 36.8	280
Locking Wheel Nut Remover 27	280
Locking Wheel Nut Remover 28	280
Locking Wheel Nut Remover 28.8	280
Locking Wheel Nut Remover 28.9	280
Locking Wheel Nut Remover 30	280
Locking Wheel Nut Remover 30.9	280
Locking Wheel Nut Remover 31.8	280
Locking Wheel Nut Remover 34.8	280
Twist Socket; 3/8", 10 mm	280
Twist Socket; 3/8", 11 mm	280
Twist Socket; 3/8", 12 mm	280
Twist Socket; 3/8", 13 mm	280
Twist Socket; 3/8", 14 mm	280
Twist Socket; 3/8", 15 mm	280
Twist Socket; 3/8", 16 mm (5/8")	280
Twist Socket; 3/8", 17 mm	280
Twist Socket; 3/8", 19 mm (3/4")	280
Twist Socket; Long, 17 mm, 1/2"	280
Twist Socket; Long, 19 mm, 1/2"	280
Twist Socket; Long, 21 mm, 1/2"	280
Twist Socket; Long, 22 mm, 1/2"	280
3-mm Lok-Typ Torx Remover	280
4-mm Lok-Typ Torx Remover	280
5-mm Lok-Typ Torx Remover	280

6-mm Lok-Typ Torx Remover	280
7-mm Lok-Typ Torx Remover	280
8-mm Lok-Typ Torx Remover	280
10-mm Lok-Typ Torx Remover	280
12-mm Lok-Typ Torx Remover	280
Locking Wheel Nut Removal Adapter; 27.0	280
Locking Wheel Nut Removal Adapter; 28.0	280
Locking Wheel Nut Removal Adapter; 28.8	280
Locking Wheel Nut Removal Adapter; 28.9	280
Locking Wheel Nut Removal Adapter; 30.0	280
Locking Wheel Nut Removal Adapter; 30.9	280
Locking Wheel Nut Removal Adapter; 31.8	280
34.8mm Socket lug Nut Socket	281
35.8mm Socket lug Nut Socket	281
36.8mm Socket lug Nut Socket	281
37.8mm Socket lug Nut Socket	281
38.8mm Socket lug Nut Socket	281
39.8mm Socket lug Nut Socket	281
Ratchet Spanner; Flexi-Head, Stubby, 10 mm	281
Ratchet Spanner; Flexi-Head, Stubby, 11 mm	281
Ratchet Spanner; Flexi-Head, Stubby, 12 mm	281
Ratchet Spanner; Flexi-Head, Stubby, 13 mm	281
Ratchet Spanner; Flexi-Head, Stubby, 14 mm	281
Ratchet Spanner; Flexi-Head, Stubby, 15 mm	281
Ratchet Spanner; Flexi-Head, Stubby, 16 mm	281
Ratchet Spanner; Reversible Switch, 10 mm	281
Ratchet Spanner; Reversible Switch, 11 mm	281
Ratchet Spanner; Reversible Switch, 12 mm	281
Ratchet Spanner; Reversible Switch, 13 mm	281
Ratchet Spanner; Reversible Switch, 14 mm	281
Ratchet Spanner; Reversible Switch, 15 mm	281
Ratchet Spanner; Reversible Switch, 16 mm	281
Ratchet Spanner; Reversible Switch, 17 mm	281
Ratchet Spanner; Reversible Switch, 18 mm	281
Ratchet Spanner; Reversible Switch, 19 mm	281
Ratchet Spanner; Reversible Switch, 20 mm	281
Ratchet Spanner; Reversible Switch, 21 mm	281
Ratchet Spanner; Reversible Switch, 22 mm	281
Ratchet Spanner; Reversible Switch, 24 mm	281
Ratchet Spanner; Reversible Switch, 8 mm	281
Ratchet Spanner; Reversible Switch, 9 mm	281
Ratchet Spanner; Aviation Type, Flexi-Head 8x10 mm	281
Ratchet Spanner; Aviation Type, Flexi-Head 10x11 mm	281
Ratchet Spanner; Aviation Type, Flexi-Head 12x13 mm	281
Ratchet Spanner; Aviation Type, Flexi-Head 14x15 mm	281
Ratchet Spanner; Aviation Type, Flexi-Head 16x18 mm	281
Ratchet Spanner; Aviation Type, Flexi-Head 17x19 mm	281
Ratchet Spanner; Ring&Ratchet, 8 mm	281
Ratchet Spanner; Ring&Ratchet, 10 mm	281
Ratchet Spanner; Ring&Ratchet, 12 mm	281

Ratchet Spanner; Ring&Ratchet, 13 mm	281
Ratchet Spanner; Ring&Ratchet, 14 mm	281
Ratchet Spanner; Ring&Ratchet, 17 mm	281
Ratchet Spanner; Ring&Ratchet, 19 mm	281
Ratchet Spanner; 8 mm	281
Ratchet Spanner; 9 mm	281
Ratchet Spanner; 10 mm	281
Ratchet Spanner; 11 mm	281
Ratchet Spanner; 12 mm	281
Ratchet Spanner; 13 mm	281
Ratchet Spanner; 14 mm	281
Ratchet Spanner; 15 mm	281
Ratchet Spanner; 16 mm	281
Ratchet Spanner; 17 mm	281
Ratchet Spanner; 18 mm	281
Ratchet Spanner; 19 mm	281
Ratchet Spanner; 21 mm	281
Ratchet Spanner; 22 mm	281
Ratchet Spanner; 24 mm	281
Ratchet Spanner; 27 mm	281
Ratchet Spanner; 30 mm	281
Ratchet Spanner; 32 mm	281
Ratchet Spanner; Flexi-Head, 8 mm	282
Ratchet Spanner; Flexi-Head, 9 mm	282
Ratchet Spanner; Flexi-Head, 10 mm	282
Ratchet Spanner; Flexi-Head, 11 mm	282
Ratchet Spanner; Flexi-Head, 12 mm	282
Ratchet Spanner; Flexi-Head, 13 mm	282
Ratchet Spanner; Flexi-Head, 14 mm	282
Ratchet Spanner; Flexi-Head, 15 mm	282
Ratchet Spanner; Flexi-Head, 16 mm	282
Ratchet Spanner; Flexi-Head, 17 mm	282
Ratchet Spanner; Flexi-Head, 19 mm	282
Ratchet Spanner; Flexi-Head, 19 mm	282
Ratchet Spanner; Flexi-Head, Stubby, 8 mm	282
Ratchet Spanner; Flexi-Head, Stubby, 9 mm	282
Ratchet Spanner; Flexi-Head, Stubby, 17 mm	282
Ratchet Spanner; Flexi-Head, Stubby, 18 mm	282
Ratchet Spanner; Flexi-Head, Stubby, 19 mm	282
Crowfoot Spanner; 1/2", 10 mm	282
Crowfoot Spanner; 1/2", 11 mm	282
Crowfoot Spanner; 1/2", 12 mm	282
Crowfoot Spanner; 1/2", 13 mm	282
Crowfoot Spanner; 1/2", 14 mm	282
Crowfoot Spanner; 1/2", 15 mm	282
Crowfoot Spanner; 1/2", 16 mm	282
Crowfoot Spanner; 1/2", 17 mm	282
Crowfoot Spanner; 1/2", 18 mm	282
Crowfoot Spanner; 1/2", 19 mm	282
Crowfoot Spanner; 1/2", 20 mm	282
Crowfoot Spanner; 1/2", 21 mm	282
Crowfoot Spanner; 1/2", 22 mm	282
Crowfoot Spanner; 1/2", 23 mm	282
Crowfoot Spanner; 1/2", 24 mm	282

Crowfoot Spanner; 1/2", 25 mm	282
Crowfoot Spanner; 1/2", 26 mm	282
Crowfoot Spanner; 1/2", 27 mm	282
Crowfoot Spanner; 1/2", 28 mm	282
Crowfoot Spanner; 1/2", 30 mm	282
Crowfoot Spanner; 1/2", 32 mm	282
Combination Spanner; 8 mm	282
Combination Spanner; 9 mm	282
Combination Spanner; 10 mm	282
Combination Spanner; 11 mm	282
Combination Spanner; 12 mm	282
Combination Spanner; 10 mm	282
Combination Spanner; 14 mm	282
Combination Spanner; 15 mm	282
Combination Spanner; 16 mm	282
Combination Spanner; 17 mm	282
Combination Spanner; 18 mm	282
Combination Spanner; 19 mm	282
Combination Spanner; 21 mm	282
Combination Spanner; 22 mm	282
Combination Spanner; 23 mm	282
Combination Spanner; 24 mm	282
Combination Spanner; 25 mm	282
Combination Spanner; 26 mm	282
Combination Spanner; 27 mm	282
Combination Spanner; 28 mm	282
Combination Spanner; 30 mm	282
Combination Spanner; 32 mm	282
Spanner; Aviation Type, Double Ring, 8x9 mm	283
Spanner; Aviation Type, Double Ring, 8x10 mm	283
Spanner; Aviation Type, Double Ring, 10x12 mm	283
Spanner; Aviation Type, Double Ring, 11x13 mm	283
Spanner; Aviation Type, Double Ring, 14x15 mm	283
Spanner; Aviation Type, Double Ring, 16x17 mm	283
Spanner; Aviation Type, Double Ring, 18x19 mm	283
Spanner; Aviation Type, Double Ring, 21x23 mm	283
Spanner; Aviation Type, Double Ring, 22x24 mm	283
Creeper & Seat for Mechanics	285
Creeper Seat; Welzh	285
Support Hook; Universal	285
Uni-Support Hook: 4-Piece Kit	285
Mechanics Knee Protection Matt With EVA Technology	286
Mechanics Working Mat With EVA Technology	286
Mechanics Working Matt With EVA Technology	286
Mechanics Foldable Work Matt	286
Gloves; Mechanics Style, Size: L	287
Welding Helmet (Skull Version) Green; Automatic	287
Welding Helmet (Skull Version); Automatic	287
Welding Helmet (Flame Pattern)	287
Recovery Tie Down Straps 3000Kgs With Anti-Slip Protector	288
Adaptor For VAG Models For use with 2887-WW	288
Car Engine Oil Filling Device with Adapters	288
Fluid Extractor Manual 6-Litres	288

70 Litre Waste Oil Drain Receiver	289
70 Litre Mobile Suction Evac Oil Drainer, Air support	289
Fluid Extractor Manual & Air Operational 10-Litres	289
2-Piece Universal Oil Funnel Set	289
Oil Mate 16-Litre Oil Pan & Holder For Transmission Jack	290
16-Litre Fuel Pan	290
16-Litre Oil Pan	290
12 Volt Oil Pump	290
Booster Pack; Mini Type, 12v	291
Booster Pack, Extreme Heavy Duty; 12/24v	291
Booster Pack, Extreme Heavy Duty; 12v	291
Replacement Battery For 1121	291
Digital Battery Tester	292
Jump Leads; Heavy Duty, 6m	292
Jump Leads; Heavy Duty, 6m, 800 amp	292
Induction Rope Wire for Induction Heater	292
Induction Heater UK Plug	293
Induction Heater EU Plug	293
8-piece Induction Coil Set, Flat Type, for Induction Heater	293
8-piece Induction Coil Set for Induction Heater	293
LED Magnetic Tray	294
Magnetic Tray	294
Magnetic Tray Double	294
Extra Large Magnetic Tray Quad	294
Magnetic Air Tools Holder	295
Extra Deep Magnetic Tray	295
Retractable Power Cable Reel 13m for Electrical Tools UK fittings	295
Retractable Power Cable Reel 13m for Electrical Tools EU fittings	295
4-Piece Magnetic Trays	296
Display Stand WELZH	297
Workshop Table with Drawer; Fully Adjustable	297
XL Tool Cart 3-Drawed With Lockable Lid (Green)	297
XL Tool Cart 3-Drawed With Lockable Lid (Black)	297
Hand Held Gas Torch	298
Swivel Base For Transmisson Jack	298
Jack; 2-Ton Pneumatic, Bellow	298
Jack; 2-Ton Extended Pneumatic, Bellow	298
Car Ramps Low Profile (2-Piece Set)	299
Hydraulic Car Dolly Jack	299
Wheel Dollys 2-Piece Set	299
Transmission Jack; 600 kg, Heavy Duty	299
Transmission Jack; 500 kg	300
Transmission Jack 500kg; Telescopic Vertical	300
Trolley Jack; Mobile Type; Air Hydraulic, 20 ton	300
Trolley Jack; Aluminium, 2.5 ton	300
Trolley Jack; 3.5 ton, Heavy Duty	301
Trolley Jack; 3 ton, Heavy Duty	301
Bottle Jack; Hydraulic, 20T	301
Bottle Jack; Air & Hydraulic, 20T	301
Bottle Jack; Stubby, Air & Hydraulic, 20T	302
Portable Power Kit; 4-Ton	302



PRODUCT MAGAZINES

RELEASED EVERY 3 MONTHS

Keep up to date with the latest tools and promotions with the Welzh Magazine.

Dealers can get the PDF online or order physical copies on the B2B.



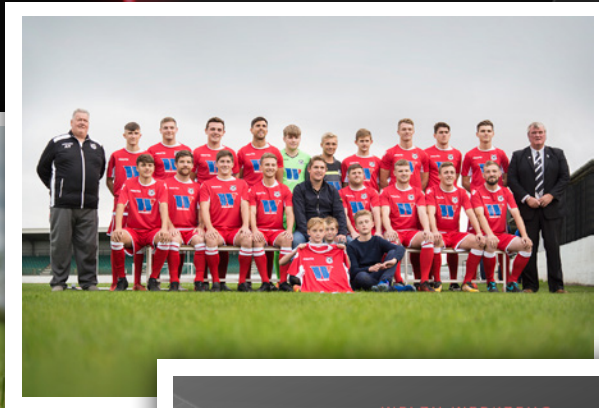

**PROUD SPONSORS OF
GRETNA FC**

We are proud to announce that as part of our local community support programme we are now sponsoring Gretna FC 2008. You will see our logo on their Away Kit and pitch-side hoarding at home.

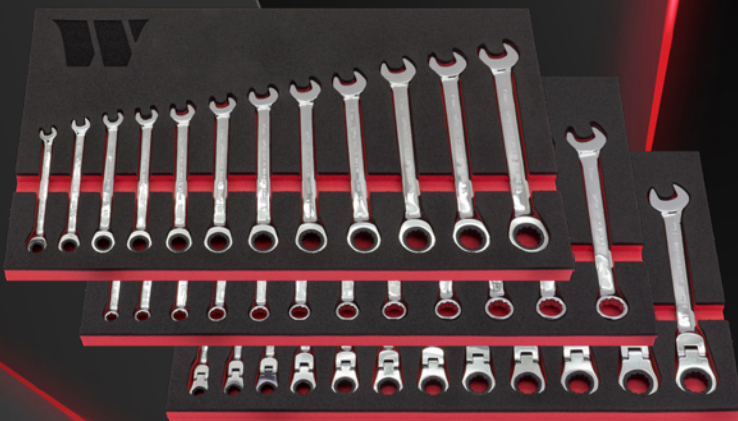

**HUNDREDS OF
NEW PRODUCTS**

AND HUNDREDS MORE IN 2019

Including a range of tools supplied in industry approved EPA foam trays compatible with tool chest drawers for convenient storage.

Welzh House
Loanwath Road
Gretna
DG16 5HD

Telephone: +44 (0)1461 700 120
Email: contact@welzhwerkzeug.com

Copyright © 2019 Welzh Werkzeug Ltd