















# TE4104 - TE4104K

ŠPECIÁLNY RÚRKOVÝ NOSIČ PRE BRAŠNE - TELAIETTO LATERALE SPECIFICO - SPECIFIC SADDLEBAG TUBULAR HOLDER - SUPPORT TUBULAIRE POUR SACOCHES CAVALIÈRES -  
PORTA ALFORJAS TUBULAR LATERAL - SUORTE LATERAL DE ALFORGES

## KAWASAKI ER-6n/ER-6f 2012

Číslo	Popis	Rozmery	Kód	Množstvo	
1	Držiak - Supporto - Support Halterung - Soporte		-	2 (Dx,Sx)	
2	Spojovacia rúrka - Rear Bridge Pont Posterieure - Verbindungsrohr Puente Trasero		-	1	
3	Držiak smeroviek - Supporto Freccia- Blinker Support Support Clignotant - Blinker Halter - Soporte Intermitente		GL1129	2 (Dx,Sx)	
4	Držiak - Supporto - Blinker Support Support - Halter - Soporte		GL2066	2	
5	Držiak - Supporto - Blinker Support Support - Halter - Soporte		GL1462	2	
6	Držiak - Supporto - Blinker Support Support - Halter - Soporte		GL1461	2	
7	Skrutka - Vite - Screw Vis - Schraube Tornillo	TCEI M8x50	-	2	
8	Skrutka - Vite - Screw Vis - Schraube Tornillo	TEF M6x16		6	
9	Skrutka - Vite - Screw Vis - Schraube Tornillo	TEF M8x20		2	
10	Skrutka - Vite - Screw Vis - Schraube Tornillo	TEF M8x50		2	
11	Matica - Dado - Bolt - Ecrou Mutter - Tuerca	Auto Bloccante Flangiato M8		2	
12	Matica - Dado - Bolt - Ecrou Mutter - Tuerca	Auto Bloccante Flangiato M6		2	
13	Matica - Dado - Bolt - Ecrou Mutter - Tuerca	Auto Bloccante Flangiato Ribassato M6		4	
14	Dištančný stĺpik - Distanziale - Spacer Entretoise - Distanzstueck Distanciador	Ø18x17 foro 8.5mm	V420	2	
15	Skrutkovací uzáver - Coprivite - Screw Cap Cache Vis - Stopsschraube Tapa Tornillo	-	Z801	2	

# TE4104 - TE4104K

ŠPECIÁLNY RÚRKOVÝ NOSIČ PRE BRAŠNE - TELAIETTO LATERALE SPECIFICO - SPECIFIC SADDLEBAG TUBULAR HOLDER - SUPPORT TUBULAIRE POUR SACOCHES CAVALIÈRES -  
PORTA ALFORJAS TUBULAR LATERAL - SUPORTE LATERAL DE ALFORGES

## KAWASAKI ER-6n/ER-6f 2012

Číslo	Popis	Rozmery	Kód	Množstvo
16	Komponenty zahrnuté v montážnej sade Monoracku Sparticolari Inclusi Nel Kit Viteria Del Monorack Components Included In The Fitting Kit Of The Monorack Pièces Incluses Dans Le Kit De Vis De El Monorack Die Einzelnen Teile Sind Bei Montagekit Der Monorack Enthalten Despieces Incluidos En El Kit De Anclajes De El Monorack		-	-

# TE4104 - TE4104K

ŠPECIÁLNY RÚRKOVÝ NOSIČ PRE BRAŠNE - TELAIETTO LATERALE SPECIFICO - SPECIFIC SADDLEBAG TUBULAR HOLDER - SUPPORT TUBULAIRE POUR SACOCHES CAVALIÈRES -  
PORTA ALFORJAS TUBULAR LATERAL - SUORTE LATERAL DE ALFORGES

## KAWASAKI ER-6n/ER-6f 2012

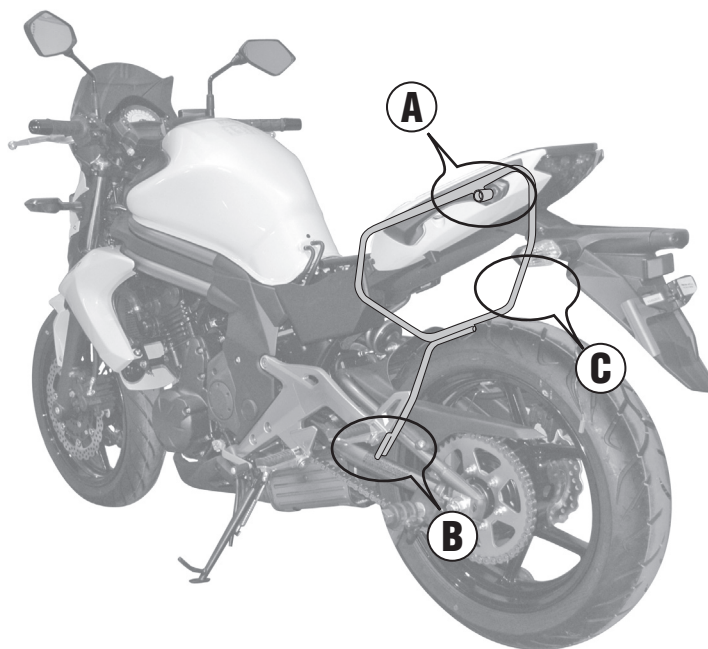

LEN ŠPECIÁLNY RÚRKOVÝ NOSIČ PRE BRAŠNE  
ONLY SPECIFIC SADDLEBAGS TUBULAR HOLDER  
SEUL SUPPORT TUBULAIRE POUR SACOCHES CAVALIÈRES  
NÜR SPEZIAL STAHLROHR-SEITENKOFFER-TRAEGER  
SOLO PORTA ALFORJAS TUBULAR LATERAL

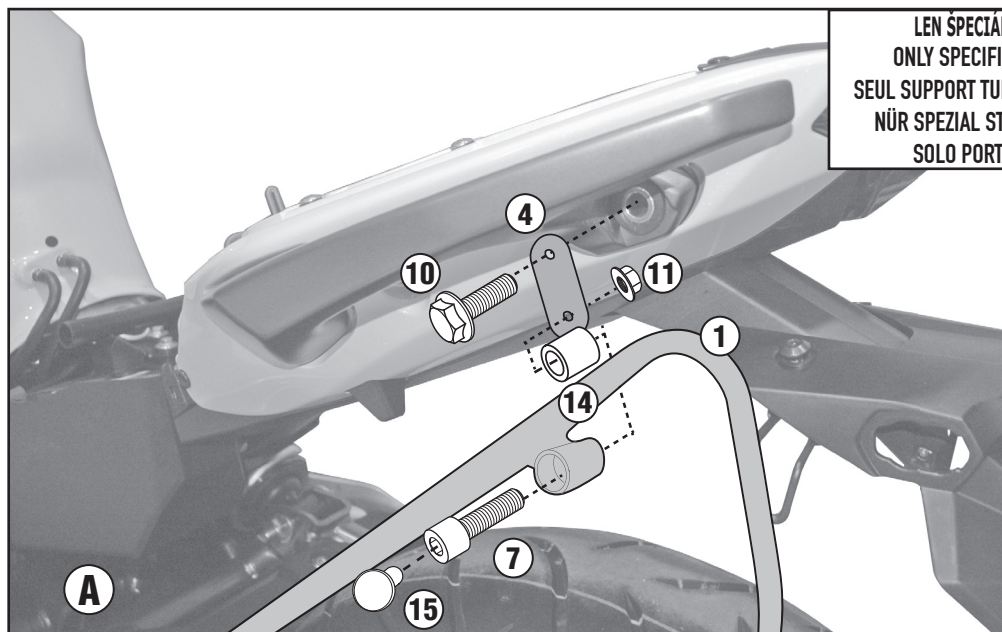

ŠPECIÁLNY MONORACK + ŠPECIÁLNY RÚRKOVÝ NOSIČ PRE BRAŠNE  
SPECIFIC MONORACK+SPECIFIC SADDLEBAGS TUBULAR HOLDER  
MONORACK SPECIFIQUE+SUPPORT TUBULAIRE POUR SACOCHES CAVALIÈRES  
SPEZIFISCHES MONORACK+SPEZIAL STAHLROHR-SEITENKOFFER-TRAEGER  
MONORACK ESPECÍFICO+PORTA ALFORJAS TUBULAR LATERAL

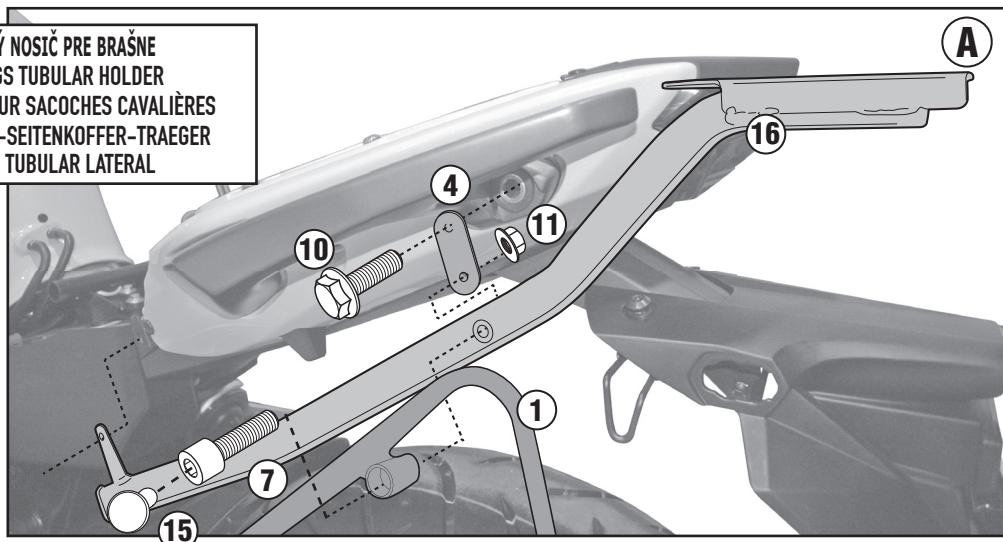

MONTÁŽNY NÁVOD - INSTRUZIONI DI MONTAGGIO - MOUNTING INSTRUCTIONS  
INSTRUCTIONS DE MONTAGE - BAUANLEITUNG  
INSTRUCCIONES DE MONTAJE - INSTRUÇÕES DE MONTAGEM

# TE4104 - TE4104K

ŠPECIÁLNY RÚRKOVÝ NOSIČ PRE BRAŠNE - TELAIETTO LATERALE SPECIFICO - SPECIFIC SADDLEBAG TUBULAR HOLDER - SUPPORT TUBULAIRE POUR SACOCHES CAVALIÈRES -  
PORTA ALFORJAS TUBULAR LATERAL - SUPORTE LATERAL DE ALFORGES

## KAWASAKI ER-6n/ER-6f 2012

