

2140KIT - 2140KITK

ŠPECIÁLNY KIT - KIT SPECIFICO - SPECIFIC KIT - KIT SPECIFIQUE - SPEZIFISCHES KIT - KIT ESPECÍFICO - KIT ESPECÍFICA

YAMAHA MT-07 (2018)

Číslo	Popis	Rozmery	Kód	Množstvo
1	Spodný držiak - Supporto inferiore - Lower support - Support inférieur - Soporte inferior - Untere Halterung - Suporte inferior	-	GL2672DXV GL2672SXV	2 (Right; Left) (pravý, ľavý)
2	Vnútrotný väčší držiak - Inner Higher Support Support Interne Supérieur - Soporte Interno Superior Inner Höhere Unterstützung - Suporte Interno Superior	-	GL3869DXV GL3869SXV	2 (Right; Left) (pravý, ľavý)
3	Spodný držiak - Supporto inferiore - Lower support - Support inférieur - Soporte inferior - Untere Halterung - Suporte inferior	-	GL3875	1
4	Skrutka - Vite - Screw Vis - Schraube Tornillo - Parafuso	TCEI M8x35	835TCEI	4
5	Skrutka - Vite - Screw Vis - Schraube Tornillo - Parafuso	TBEI M8x65	865TBEI	2
6	Skrutka - Vite - Screw Vis - Schraube Tornillo - Parafuso	TBEIFN M6x20	620TBEIFN	2
7	Skrutka - Vite - Screw Vis - Schraube Tornillo - Parafuso	TBEI M8x30	830TBEI	2
8	Otvárateľná podložka - Rondella spaccata - Split washer Scheibe - Rondelle fendue Arandela seccionada - Arruela Dentada	Ø8	Z1060	8
9	Podložka z nehrdzavejúcej ocele - Rondella Inox - Stainless Steel Washer Rondelle Inox - Rostfreie Unterlegscheibe Aus Stahl - Arandela Inox - Arruela Lisa De Aço Inox	Ø8	805RONX	4
10	Nylónová podložka - Rondella In Nylon - Nylon Washer Rondelle Original En Nylon - Nylonscheibe Arandela De Nylon - Arruela De Nylon	-	Z1979	2
11	Dištančný stĺpik - Distanziale - Spacer Entretoise - Distanzstueck Distanciadador - Espaçador	Ø18x5 Foro 8,5mm	C18L5F8,5T	2
12	Dištančný stĺpik - Distanziale - Spacer Entretoise - Distanzstueck Distanciadador - Espaçador	Ø20x3 Foro 6,5mm	C20L3F6,5T	2
13	Matica - Dado - Bolt - Ecrou Mutter - Tuerca - Porca	Dado AutoBloccante Flangiato Alto M8	8DADIAFLN	2
14	Originálne diely - Componenti Originali - Original Parts Parties Originales - Original Bauteile Componentes Originales - Componentes Originais	-	-	-
15	Komponenty zahrnuté v TE2140 Components Included In The TE2140 Pièces Inclues Dans TE2140 Die Einzelnen Teile Sind Bei TE2140 Despieces Incluidos TE2140 Componentes incluidos na TE2140	-	-	-

2140KIT - 2140KITK

ŠPECIÁLNY KIT - KIT SPECIFICO - SPECIFIC KIT - KIT SPECIFIQUE - SPEZIFISCHES KIT - KIT ESPECÍFICO - KIT ESPECÍFICA

YAMAHA MT-07 (2018)

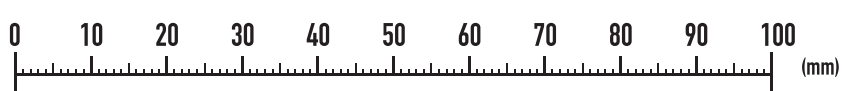
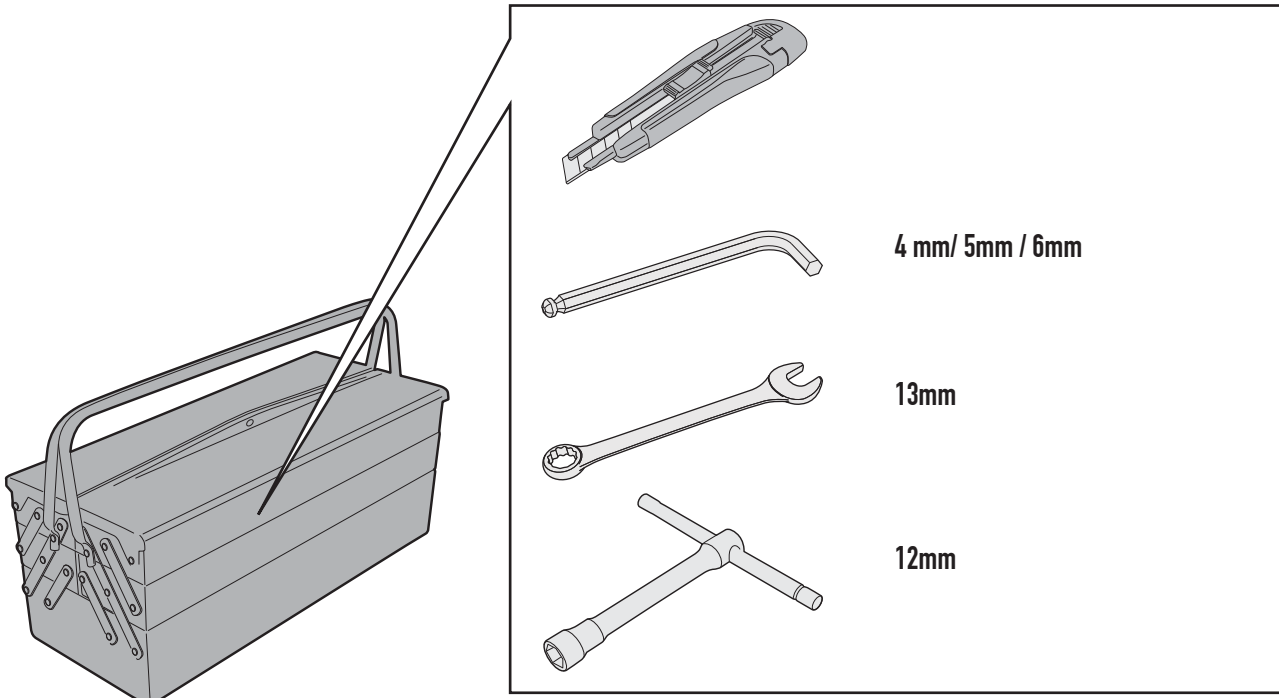
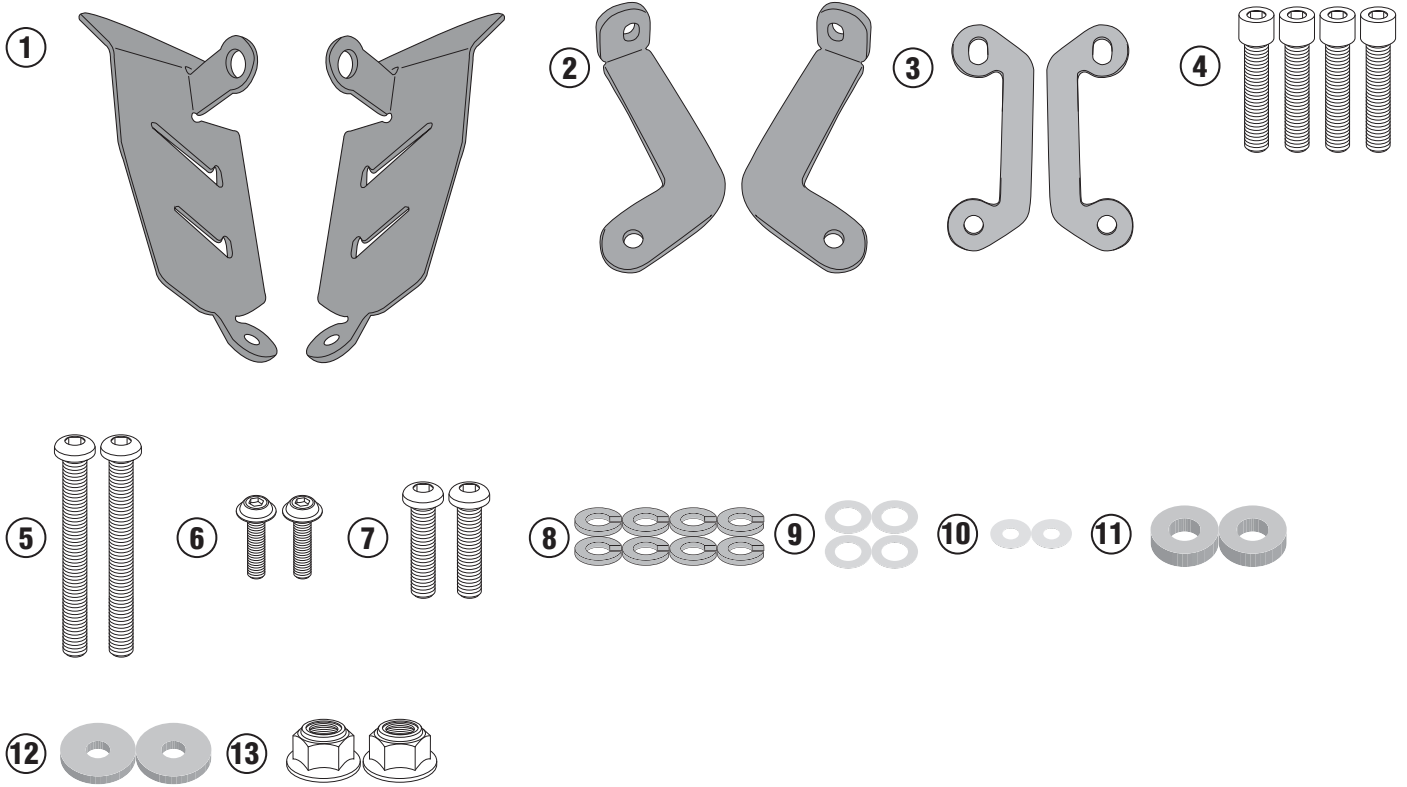

2140KIT - 2140KITK

ŠPECIÁLNY KIT - KIT SPECIFICO - SPECIFIC KIT - KIT SPECIFIQUE - SPEZIFISCHES KIT - KIT ESPECÍFICO - KIT ESPECÍFICA

YAMAHA MT-07 (2018)

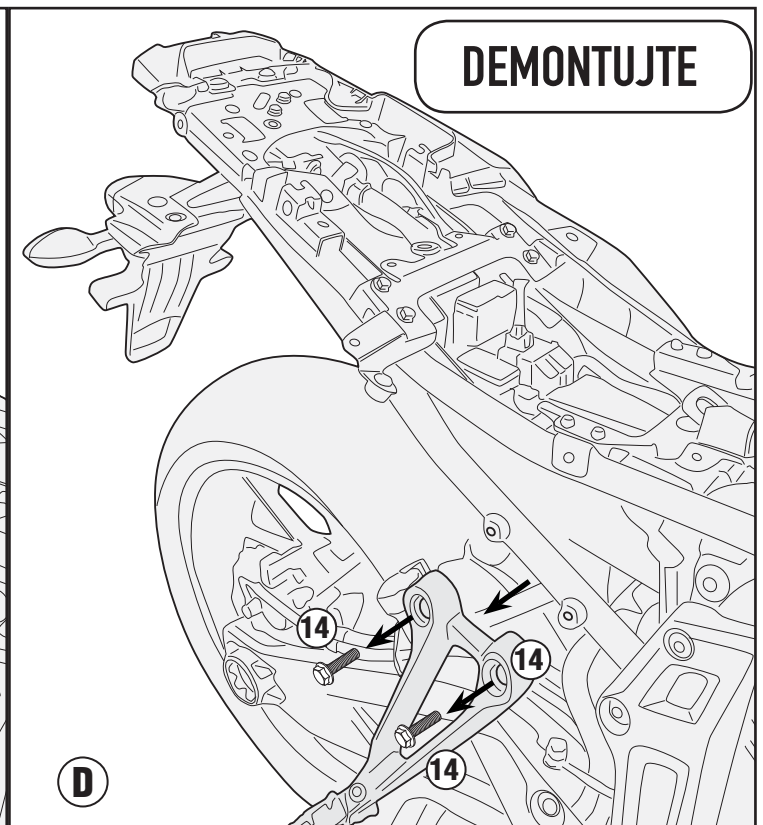
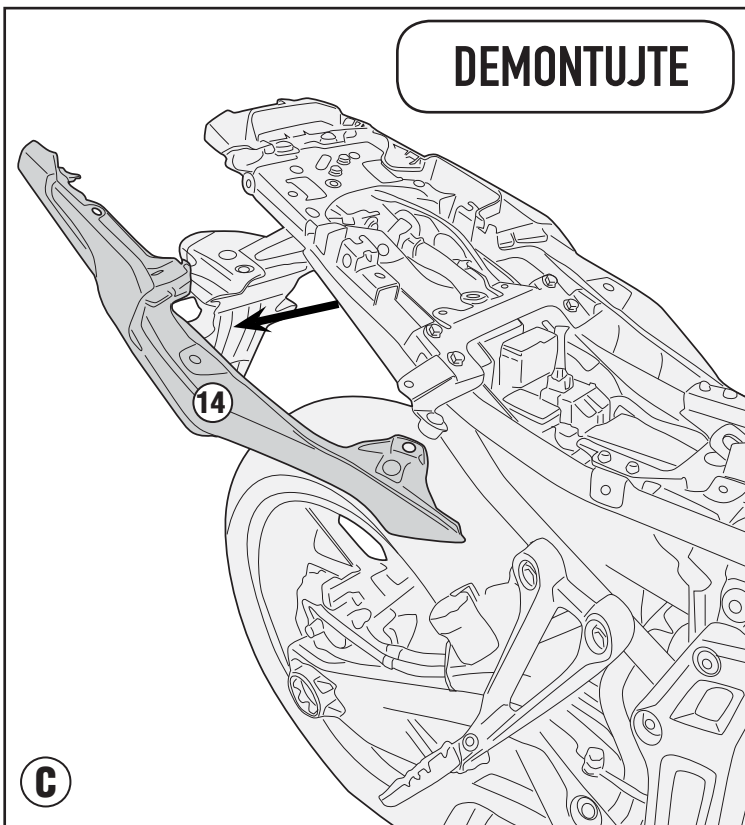
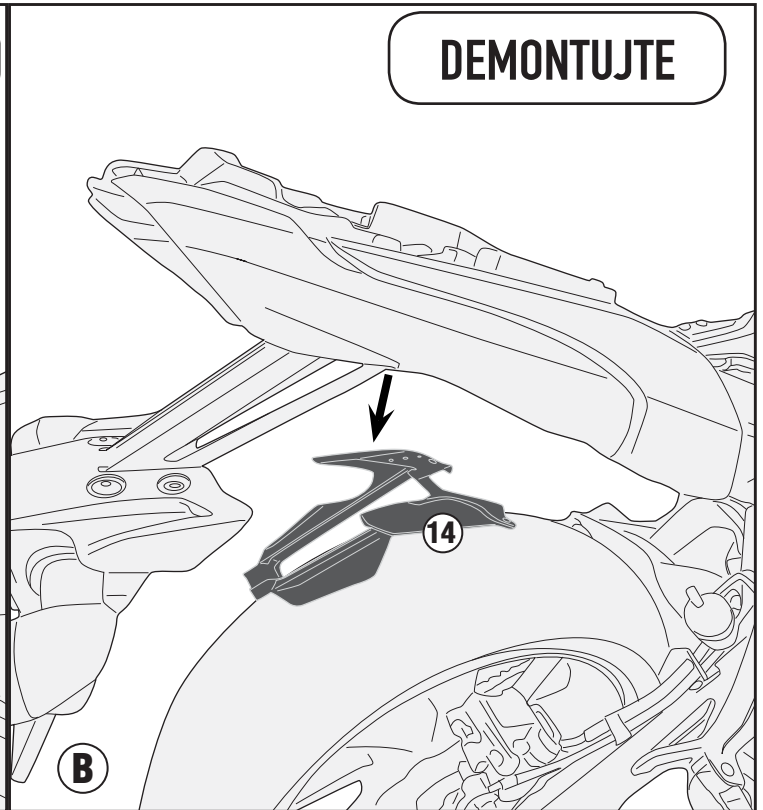
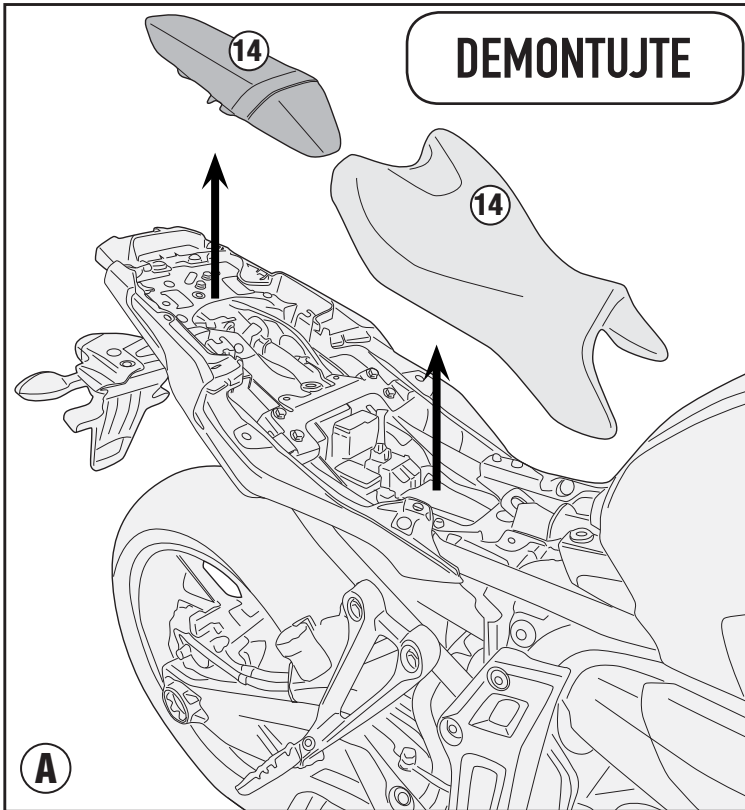

2140KIT - 2140KITK

ŠPECIÁLNY KIT - KIT SPECIFICO - SPECIFIC KIT - KIT SPECIFIQUE - SPEZIFISCHES KIT - KIT ESPECÍFICO - KIT ESPECÍFICA

YAMAHA MT-07 (2018)

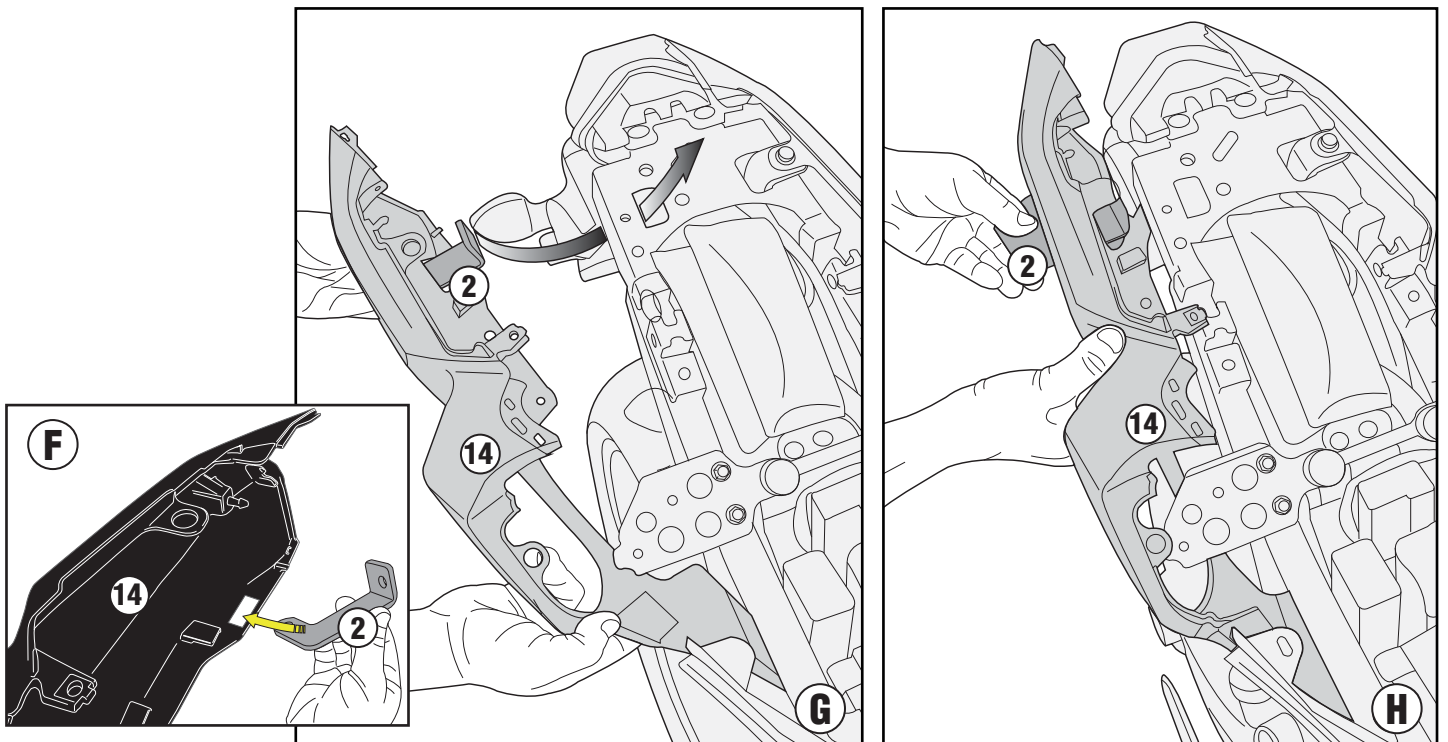
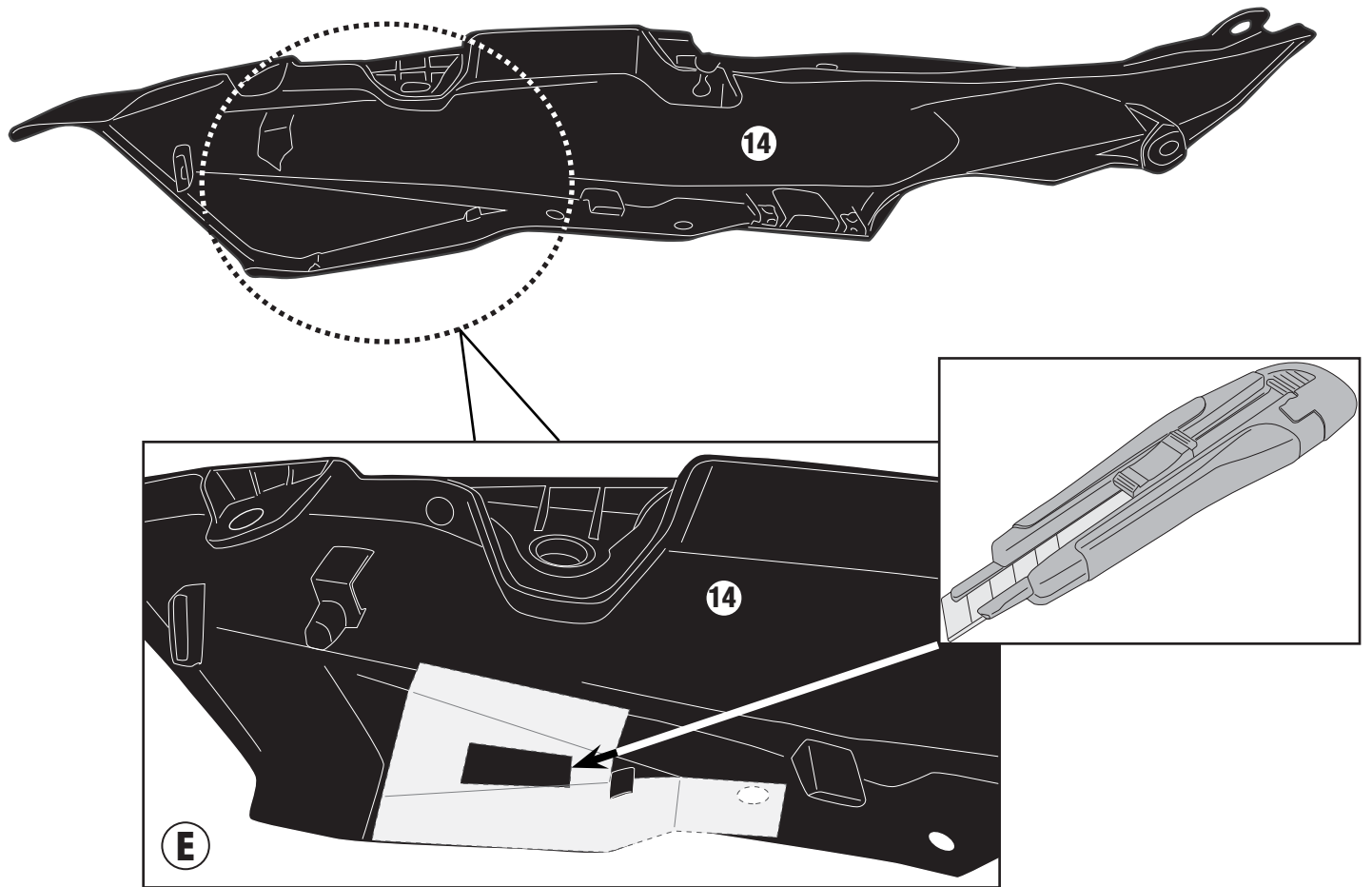

2140KIT - 2140KITK

ŠPECIÁLNY KIT - KIT SPECIFICO - SPECIFIC KIT - KIT SPECIFIQUE - SPEZIFISCHES KIT - KIT ESPECÍFICO - KIT ESPECÍFICA

YAMAHA MT-07 (2018)

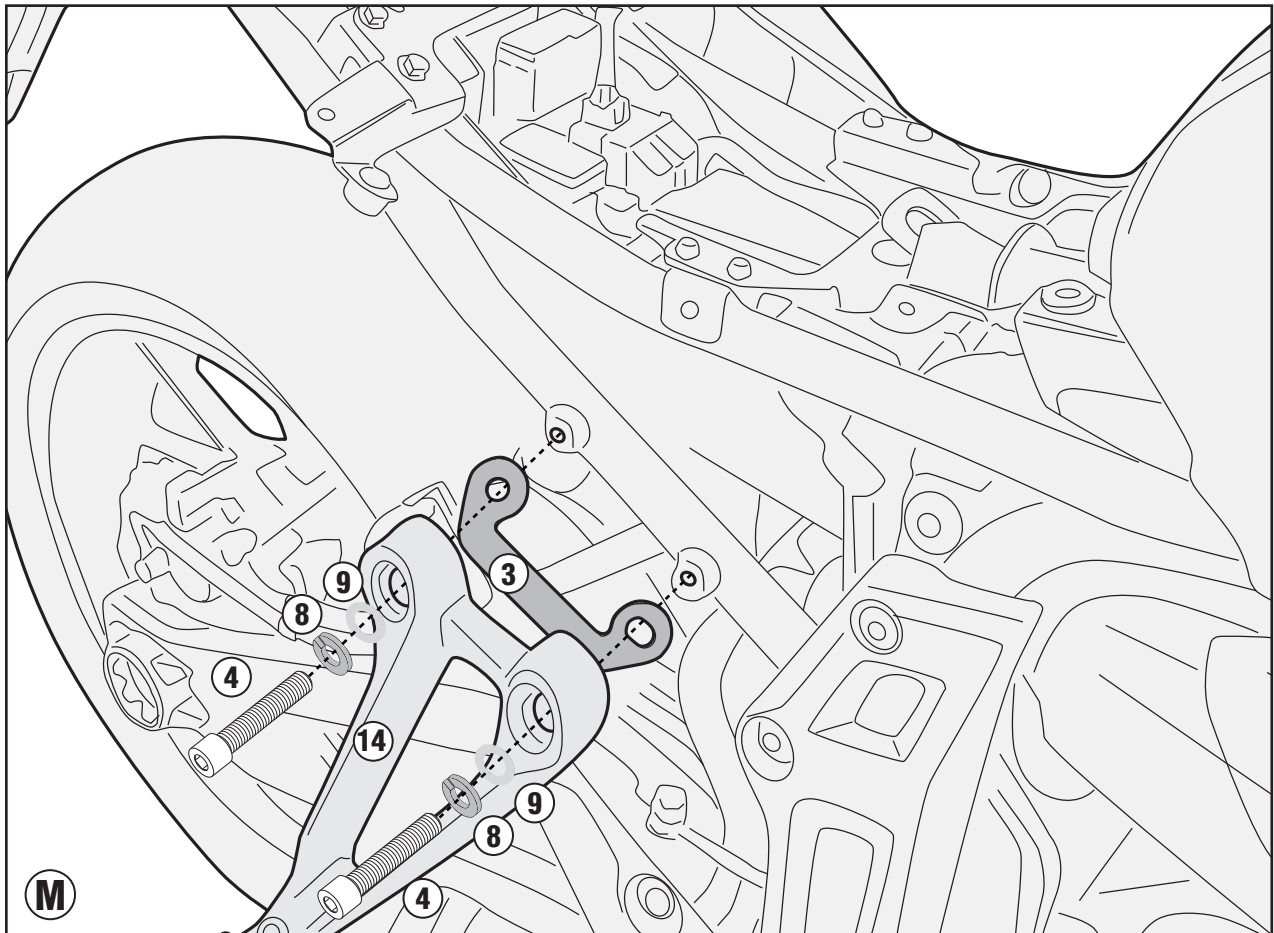
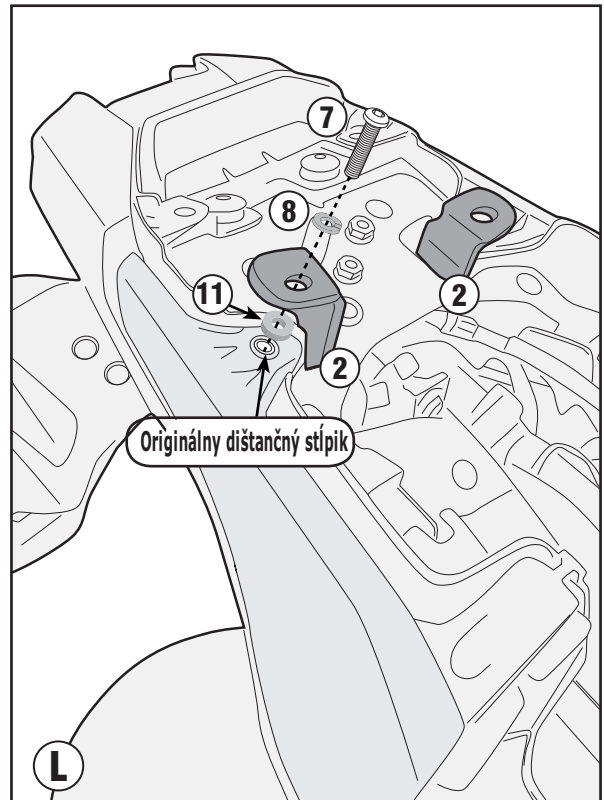
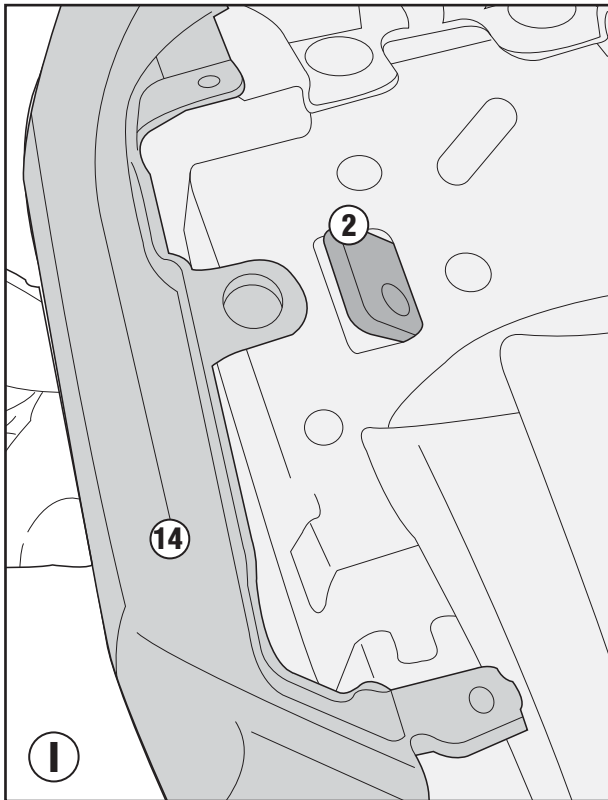

2140KIT - 2140KITK

ŠPECIÁLNY KIT - KIT SPECIFICO - SPECIFIC KIT - KIT SPECIFIQUE - SPEZIFISCHES KIT - KIT ESPECÍFICO - KIT ESPECÍFICA

YAMAHA MT-07 (2018)

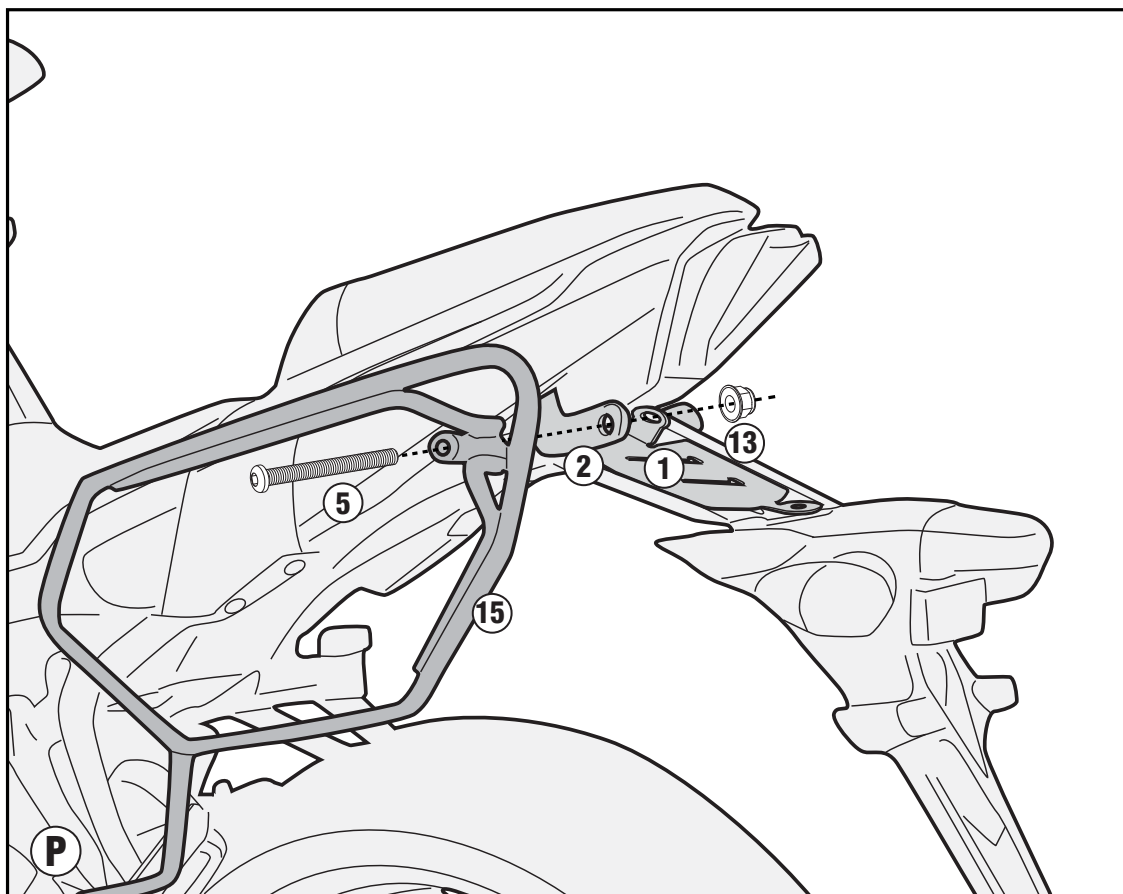
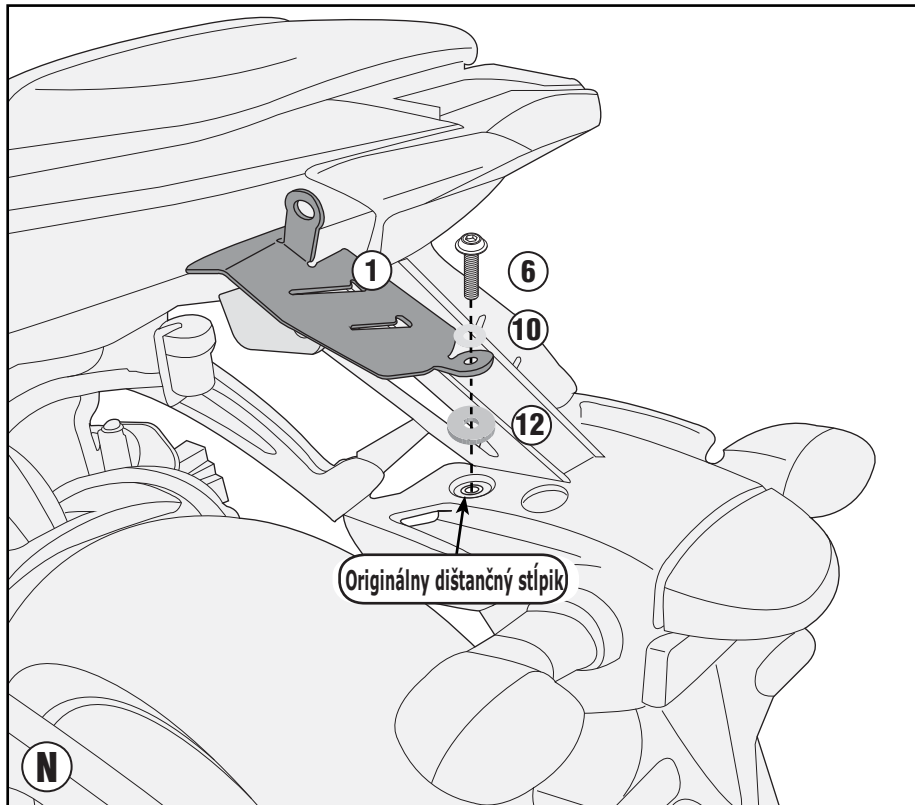

2140KIT - 2140KITK

ŠPECIÁLNY KIT - KIT SPECIFICO - SPECIFIC KIT - KIT SPECIFIQUE - SPEZIFISCHES KIT - KIT ESPECÍFICO - KIT ESPECÍFICA

YAMAHA MT-07 (2018)

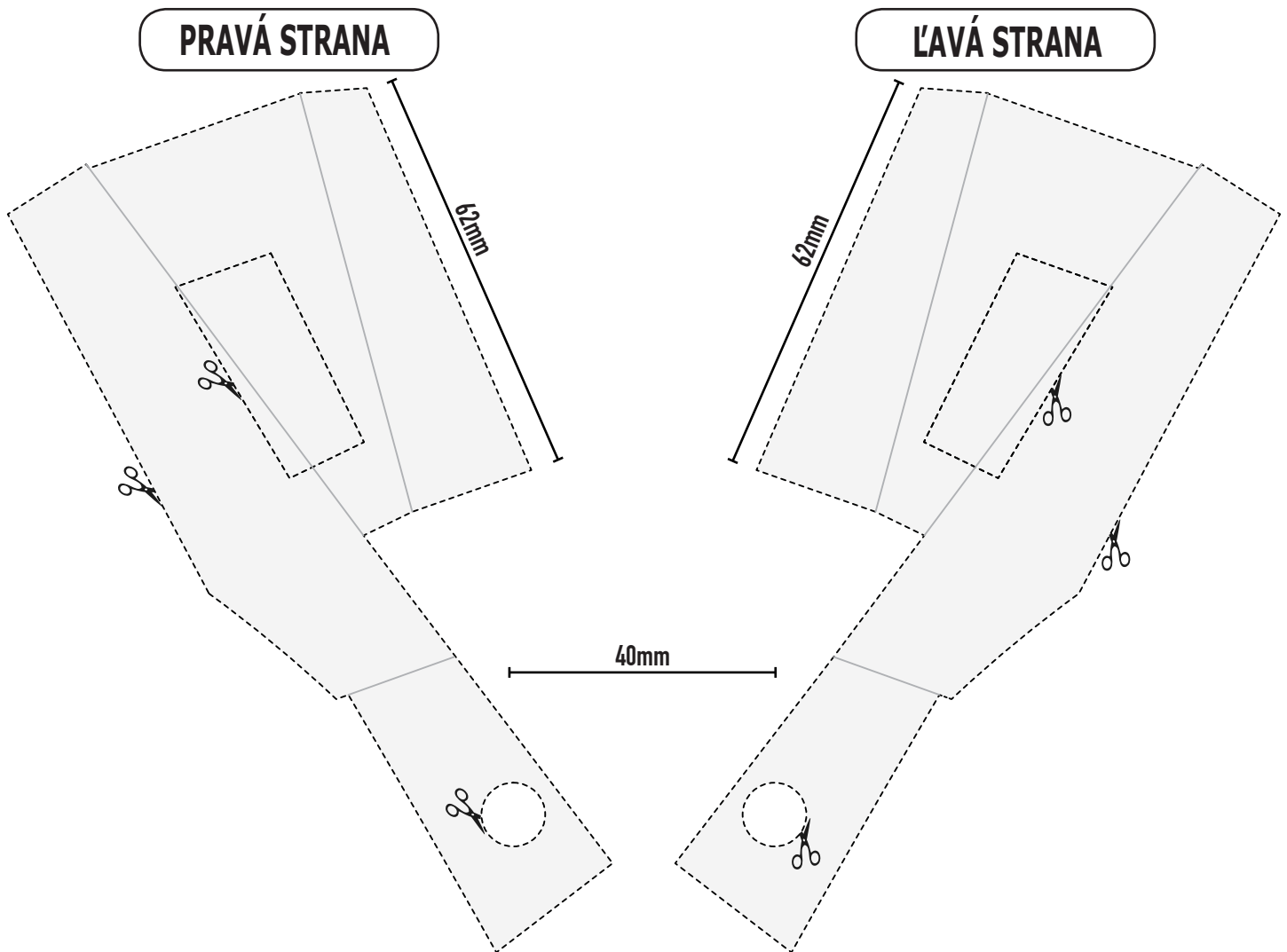

PRED VRTANÍM DIER SKONTROLUJTE, ČI SÚ ROZMERY NA ŠABLÓNE ZHODNÉ
. PRIMA DI FORARE VERIFICARE CHE LA DIMA CORRISPONDA ALLE MISURE INDICATE
. BEFORE DRILLING HOLES CHECK THAT MEASURES ON TEMPLATE CORRESPOND
. AVANT DE PERCER CONTROLER QUE LE GABARIT CORRESPOND AUX MESURES INDIQUEE
. BEVOR DER KOFFERDECKEL DURCHBOHRT WIRD, PRÜFEN SIE DAB DIE SCHABLONE DEN GEGEBENEN ABMESSUNGEN ENTSPRICHT
. ANTES DE HACER LOS AGUJEROS COMPROBAR LAS MEDIDAS DE LA PLANTILLA CORRESPONIENTE