

SONOFF

ZBMINI

User manual V1.1

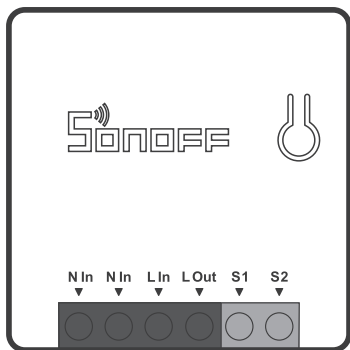

ZigBee Smart Switch

· 中文	1 - 6	· English	7-12
· Deutsch	13-18	· Español	19-24
· Français	25-30	· Italiano	31-36
· Русский язык	37-42	· Português	43-48
· FCC Warning	49		

本设备需连接SONOFF ZigBee网关进行智能操作。

⚠ 设备支持其他无线协议为ZigBee 3.0的网关, 具体以实际产品为准。

断电

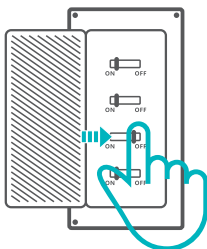

⚠ 设备安装、故障维修请由专业资质电工操作, 以免发生触电危险! 设备在正常使用的情况下不可触碰到。

接线

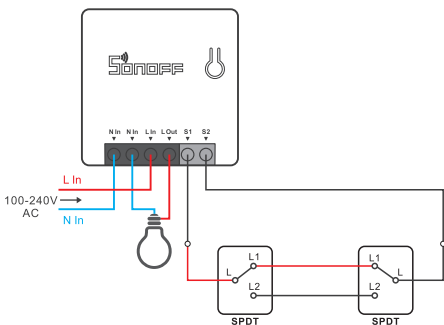

⚠ 确保零火线接入无误。

⚠ S1/S2接或不接机械开关两端(不支持自动回弹的机械开关), 设备都可以正常使用。为确保安全, 请勿接入零火线等强电。

ZSS配置说明

1. 下载最新版Alexa App



Amazon Alexa

2. 添加亚马逊音箱

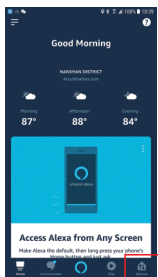

>

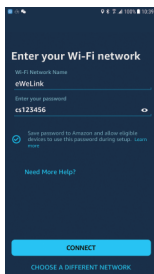

3. 添加设备

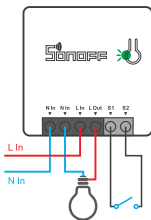

将设备上电后,等待1-2分钟,再刷新Alexa App的设备列表,即可看到新添加的设备。

⚠ 如果ZSS配置失败,可通过“易微联”App进行配网。

易微联 App 配网

1. 下载“易微联”APP



Android™ & iOS

2. 添加SONOFF ZigBee网关

3. 上电

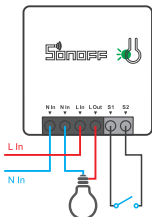

通电后，设备首次使用，默认进入配对状态，信号指示灯呈“闪烁”状态。

⊙ 如长时间未进行下一步操作，设备可能退出配对模式，如需再次进入，长按手动开关5秒直到信号指示灯“闪烁”即可。

4. 添加子设备

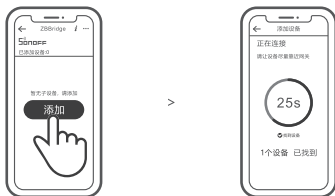

打开eWeLink APP，选择要连接的网关，点击“添加”子设备，等待搜索添加设备。

⊙ 如添加失败，请将设备移近网关后再重新添加。

SONOFF ZigBee网关支持同时连接多个子设备

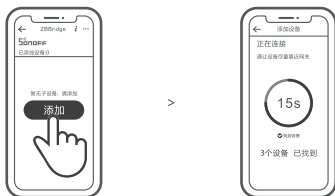

先将网关通电, 设置让所需配对的子设备进入配对状态, 然后打开eWeLink APP网关页面, 点击“添加”, 等待搜索添加设备。

更多APP应用平台及网关推荐



SmartThings



Amazon Alexa

本设备除支持SONOFF ZigBee网关外, 还支持以下网关:

Echo Studio
Echo Plus (型号: ZE39KL)
2nd Gen Echo Show (型号: DW84JL)
2nd Gen Echo Plus (型号: L9D29R)
Samsung SmartThings hub

添加说明:

1. 参照网关使用说明书下载相应APP和连接网关。
2. 将设备设置到配对模式。
3. 根据网关对应的APP提示添加设备, 添加过程中选择 eWeLink 或 SONOFF 品牌。

⚠ 如添加失败, 请将设备移近网关后再重新添加。

产品参数

产品型号	ZBMINI
输入	100-240V AC 50/60Hz 10A Max
输出	100-240V AC 50/60Hz 10A Max
ZigBee	IEEE 802.15.4
支持平台	Android & iOS
工作温度	-10~40°C
外壳材料	PC
产品规格	42.6x42.6x20mm

产品介绍

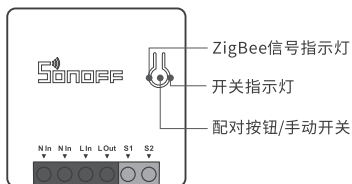

⚠ 设备重量 < 1Kg, 建议安装高度 < 2米。

产品特点

SONOFF智能开关 (ZigBee版) 基于ZigBee无线通讯协议, 通过连接ZigBee网关实现远程控制、设置定时开关、设备智能场景联动等功能。



远程控制



智能定时/延时



语音控制



智能场景控制



分享功能

⚠ 以上功能特点取决于ZigBee网关的功能。

恢复出厂设置

长按配对按钮5秒直到信号指示灯呈“闪烁”状态，再松开，此时设备重置成功，默认进入配对状态。

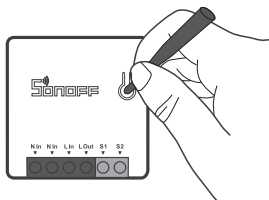

⚠ 设备重新与网关进行配对时，需要将设备恢复为出厂状态。

The device can be operated intelligently via working with the SONOFF ZigBee Bridge.

⚠ The device can work with other gateways supporting ZigBee 3.0 wireless protocol. Detailed information is in accordance with the final product.

Power off

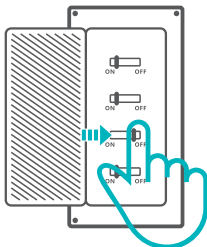

⚠ To avoid electric shocks, please consult the dealer or a qualified professional for help when installing and repairing! Please do not touch the switch during use.

Wiring instruction

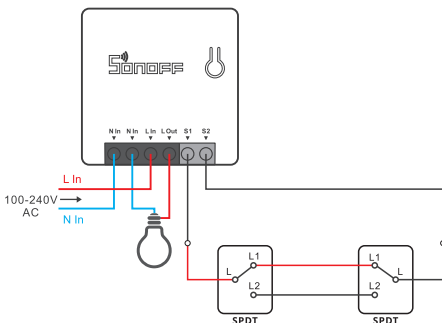

⚠ Make sure the neutral wire and live wire connection is correct.

⚠ S1/S2 can connect with the rocker light switch (the self-return rocker light switch is not supported) or doesn't connect. To ensure safety, do not connect the neutral wire and live wire to it.

ZSS setup instruction

1. Download the latest Alexa App



Amazon Alexa

2. Add Amazon Echo

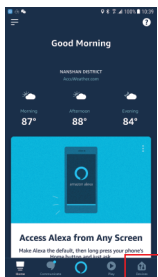

>

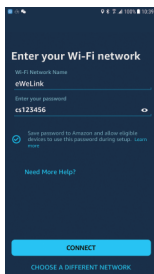

3. Add device

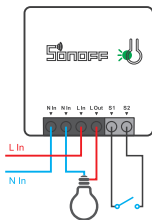

After the device is powered on, wait 1-2 mins to refresh the device list in Alexa App, and the added device will appear in the device list.

⚠ Please try to pair the device using eWeLink App if ZSS setup is failed.

eWeLink App pairing

1. Download APP

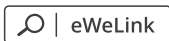

Android™ & iOS

2. Add SONOFF ZigBee Bridge

3. Power on

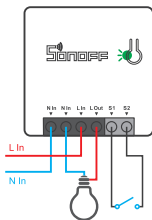

After powering on, the device will enter the pairing mode during the first use and the LED signal indicator flashes.

⚠ The device will exit the pairing mode if no next operation for a long time. If enter again, please long press the manual switch for 5s until the LED signal indicator flashes and release.

4. Add sub-devices



>



Access eWeLink APP, select the Bridge that you want to connect, and tap "Add" to add a sub-device, and be patient until pairing completes.

⚠ If the addition failed, move the sub-device closer to the Bridge and try again.

SONOFF ZigBee Bridge supports connecting multiple sub-devices at the same time.

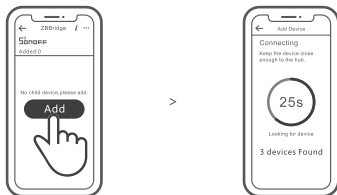

Power the Bridge on, set the sub-device to the pairing mode. Then access the Bridge page in the eWeLink APP to tap "Add", and be patient until the pairing completes.

More APP application platforms and gateway recommendations



SmartThings



Amazon Alexa

This device supports the following gateways besides SONOFF ZigBee:

Echo Studio
Echo Plus (model: ZE39KL)
2nd Gen Echo Show (model: DW84JL)
2nd Gen Echo Plus (model: L9D29R)
Samsung SmartThings hub

Gateway adding instruction:

1. Refer to the gateway user manual to download the matched APP and get it paired.
2. Set ZBMINI to the pairing mode.
3. Add ZBMINI according to the prompt of APP. You should select eWeLink or SONOFF when adding.

⚠ If the addition failed, move the sub-device closer to the Bridge and try again.

Specifications

Model	ZBMINI
Input	100-240V AC 50/60Hz 10A Max
Output	100-240V AC 50/60Hz 10A Max
ZigBee	IEEE 802.15.4
Operating systems	Android & iOS
Working temperature	-10~40°C
Material	PC
Dimension	42.6x42.6x20mm

Product Introduction

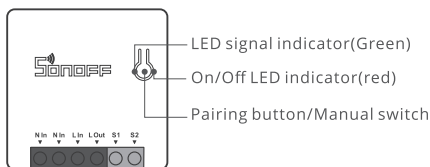

- ⚠ The device weight is less than 1 kg.
The installation height of less than 2 m is recommended.

Features

SONOFF ZigBee smart devices based on ZigBee wireless communication protocol allow you to remotely turn on/off, schedule on/off connected devices, and set smart scenes, etc.



Remote Control



Single/Countdown
Timing



Voice Control



Smart Scene



Share Control

- ⚠ Above functions are determined by ZigBee Hub.

Factory Reset

Long press the configuration button for 5s until the LED signal indicator flashes and release, then the reset is successful. The device enters pairing mode.

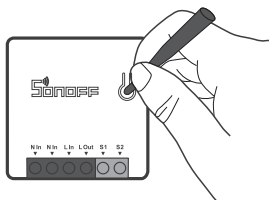

ⓘ If pair the device with hub again, please reset the device to factory default.

Das Gerät kann intelligent betrieben werden, indem man mit dem SONOFF ZigBee Gateway arbeitet.

⚠ Das Gerät kann mit anderen Gateways zusammenarbeiten, die das drahtlose ZigBee 3.0-Protokoll unterstützen. Detaillierte Informationen sind in Übereinstimmung mit dem Endprodukt.

Ausschalten

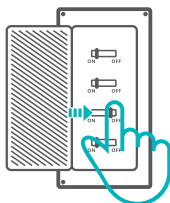

⚠ Wenden Sie sich bitte an den Händler oder einen qualifizierten Fachmann, um Hilfe bei der Installation und Reparatur zu erhalten und um Stromschläge zu vermeiden! Bitte berühren Sie den Schalter nicht während des Betriebs nicht.

Verkabelungsanleitung

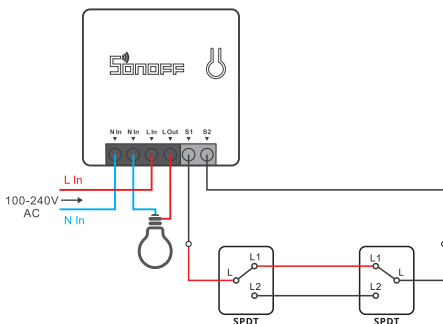

⚠ Vergewissern Sie sich, dass der Anschluss von Neutralleiter und stromführender Phase korrekt sind.

⚠ S1/S2 kann mit dem Wippenlichtschalter verbunden werden (der sich selbst zurücksetzende Wippenlichtschalter wird nicht unterstützt), muss aber nicht damit verbunden werden. Schließen Sie aus Sicherheitsgründen keine stromführende Phase und keinen Neutralleiter daran an.

ZSS-Installationsanweisungen

1. Laden Sie die neueste Alexa App herunter



Amazon Alexa

2. Fügen Sie Amazon Echo hinzu

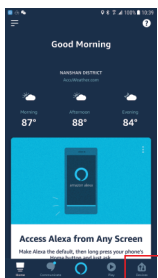

>

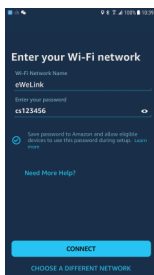

3. Gerät hinzufügen

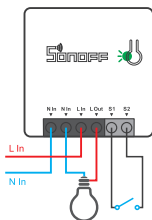

Warten Sie nach dem Einschalten des Geräts 1-2 Minuten, um die Geräteliste in der Alexa App zu aktualisieren, sodass das hinzugefügte Gerät in der Geräteliste erscheint.

⚠ Versuchen Sie bitte, das Gerät anhand der eWeLink App zu verknüpfen, falls die ZSS-Konfiguration fehlschlägt.

Verknüpfung der eWeLink App

1. APP herunterladen

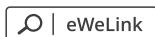

Android™ & iOS

2. Fügen Sie SONOFF ZigBee Bridge hinzu

3. Einschalten

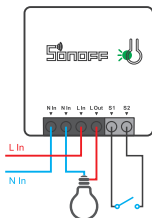

Nach dem Einschalten schaltet sich das Gerät während des ersten Gebrauchs in den Kopplungsmodus und die LED-Signalanzeige blinkt.

⚠ Das Gerät verlässt den Kopplungsmodus, wenn über einen längeren Zeitraum keine weitere Bedienung erfolgt. Bei erneuter Eingabe drücken Sie bitte den Handschalter 5 Sekunden lang gedrückt, bis die LED-Signalanzeige blinkt und dann loslassen.

4. Untergeräte hinzufügen



>



Rufen Sie eWeLink APP auf, wählen Sie das Gateway, das Sie verbinden möchten, und tippen Sie auf „Hinzufügen“, um ein Untergerät hinzuzufügen, und haben Sie Geduld, bis die Kopplung abgeschlossen ist.

⚠ Wenn das Hinzufügen fehlgeschlagen ist, bewegen Sie das Untergerät näher an das Gateway und versuchen Sie es erneut.

SONOFF das ZigBee-Gateway unterstützt die gleichzeitige Verbindung mehrerer Untergeräte.

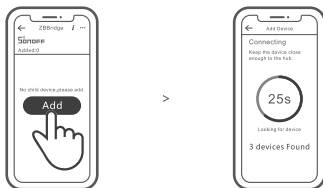

Schalten Sie die Gateway ein, stellen Sie das Untergerät in den Kopplungsmodus. Rufen Sie dann die Seite Gateway in der eWeLink APP auf, um auf „Hinzufügen“ zu tippen, und warten Sie, bis die Kopplung abgeschlossen ist.

Mehr APP-Anwendungsplattformen und Gateway-Empfehlungen



SmartThings



Amazon Alexa

Dieses Gerät unterstützt neben SONOFF ZigBee die folgenden Gateways:

Echo Studio
Echo Plus (Modell: ZE39KL)
2nd Gen Echo Show (Modell: DW84JL)
2nd Gen Echo Plus (Modell: L9D29R)
Samsung SmartThings hub

Anweisung zum Hinzufügen von Gateway:

1. Lesen Sie im Gateway-Benutzerhandbuch nach, um das passende APP herunterzuladen und es zu koppeln.
2. Stellen Sie ZBMINI in den Kopplungsmodus ein.
3. Fügen Sie ZBMINI entsprechend der Aufforderung der APP hinzu. Beim Hinzufügen sollten Sie eWeLink oder SONOFF wählen.

ⓘ If the addition failed, move the sub-device closer to the Bridge and try again.

Technische Daten

Modell	ZBMINI
Eingang	100-240V AC 50/60Hz 10A Max
Ausgang	100-240V AC 50/60Hz 10A Max
ZigBee	IEEE 802.15.4
Betriebssysteme	Android & iOS
Arbeitstemperatur	-10~40°C
Materialien	PC
Abmessungen	42.6x42.6x20mm

Produktvorstellung

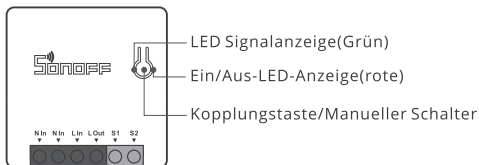

- ⚠ Das Gerätegewicht beträgt weniger als 1 kg.
Es wird eine Installationshöhe von weniger als 2 m empfohlen.

Merkmale

SONOFF ZigBee smartes Gerät, welches auf dem ZigBee drahtlosen Kommunikationsprotokoll aufbaut, ermöglicht Ihnen das ferngesteuerte Ein-/Ausschalten, die Planung des Ein-/Ausschaltens verbundener Geräte und die Einstellung intelligenter Szenen usw.



App
Fernbedienung



Einzel-/
Countdown-Timer



Sprachsteuerung



Intelligente
Szenarien



Freigabesteuerung

- ⚠ Alle Funktionen werden durch den ZigBee Hub bestimmt.

Zurücksetzen auf Werkseinstellungen

Drücken Sie die Konfigurationstaste 5 Sekunden lang gedrückt, bis die LED-Signalanzeige blinkt und dann loslassen, dann ist der Reset erfolgreich. Das Gerät schaltet in den Kopplungsmodus.

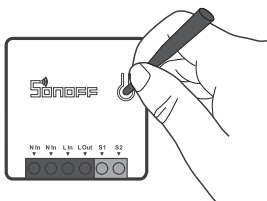

- ⚠ Wenn Sie das Gerät erneut mit dem Hub koppeln, setzen Sie das Gerät bitte auf die Werkseinstellungen zurück.

El dispositivo puede operarse de forma inteligente trabajando con el SONOFF de ZigBee puerta de enlace.

- ⚠ El dispositivo puede trabajar con otras puertas de enlace que sean compatibles con el protocolo inalámbrico de ZigBee 3.0. La información detallada es conforme al producto final.

Apagado

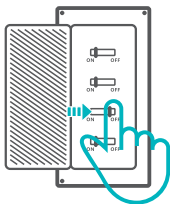

- ⚠ Para evitar descargas eléctricas, consulte con su distribuidor o un profesional cualificado para solicitar ayuda durante la instalación y la reparación!
No toque el interruptor durante el uso.

Instrucciones de cableado

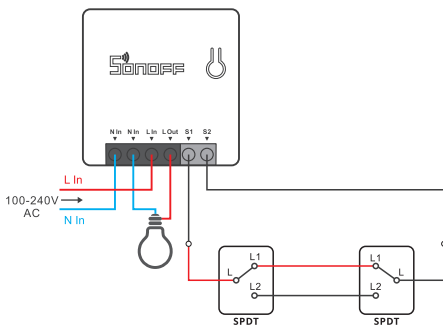

- ⚠ Compruebe que las conexiones del cable neutro y activo sean correctas.
- ⚠ Posible conectar S1/S2 con el interruptor de la luz (no se admiten pulsadores) o no conectarlo. Para garantizar la seguridad, no conecte el cable neutro y el activo al dispositivo.

Instrucción de configuración de ZSS

1. Descargue la última App Alexa



Amazon Alexa

2. Adicione Amazon Echo

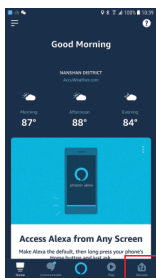

>

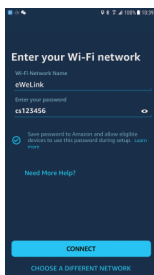

3. Añadir el dispositivo

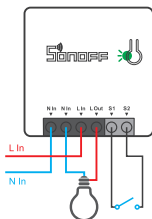

Después de encender el dispositivo, espere 1-2 minutos para que se actualice la lista de dispositivos en App Alexa, después de los cuales el dispositivo añadido App en dicha lista.

⚠️ Intente sincronizar el dispositivo usando la App eWeLink si la configuración ZSS falla.

Sincronización de la aplicación eWeLink

1. Descargar la aplicación

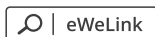

Android™ & iOS

2. Adicione SONOFF ZigBee Bridge

3. Encender

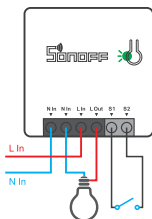

Después de encender el dispositivo, este se pondrá en modo de emparejamiento durante el primer uso y el indicador de señal LED emitirá parpadeos.

⚠ El dispositivo saldrá del modo de emparejamiento si no entra en funcionamiento por durante un largo periodo. Si vuelve a ingresar, mantenga presionado el interruptor manual durante 5 segundos hasta que el indicador de señal LED parpadee y suelte el botón.

4. Agregar subdispositivos

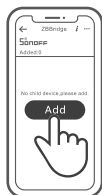

>

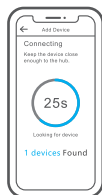

Acceda a la aplicación eWeLink, seleccione la puerta de enlace que desee conectar y toque en “Agregar” para agregar el subdispositivo, y tenga paciencia hasta que se complete el emparejamiento.

⚠ Si se produce un error al agregar, mueva el subdispositivo más cerca de la puerta de enlace e inténtelo de nuevo.

El SONOFF del puerta de enlace de ZigBee es compatible con la conexión de múltiples subdispositivos al mismo tiempo.

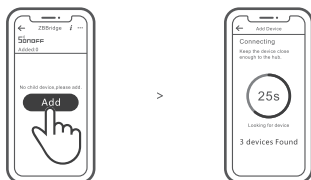

Encienda el Puente, configure el dispositivo subordinado en el modo de emparejamiento. Luego acceda a la página Puente en la aplicación eWeLink para tocar "Agregar" y sea paciente hasta que se complete el emparejamiento.

Más plataformas de aplicaciones y recomendaciones de pasarelas



SmartThings



Amazon Alexa

Este dispositivo admite las siguientes pasarelas además de SONOFF ZigBee:

Echo Studio
Echo Plus (Modelo: ZE39KL)
2nd Gen Echo Show (Modelo: DW84JL)
2nd Gen Echo Plus (Modelo: L9D29R)
Samsung SmartThings hub

Instrucciones de adición de pasarelas:

1. Consulte el manual del usuario de la pasarela para descargar la aplicación correspondiente y emparejarla.
2. Establezca ZBMINI en el modo de emparejamiento.
3. Agregue ZBMINI de acuerdo con la solicitud de aplicación. Debe seleccionar eWeLink o SONOFF para agregar.

⚠ Si se produce un error al agregar, mueva el subdispositivo más cerca de la puerta de enlace e inténtelo de nuevo.

Especificaciones

Modelo	ZBMINI
Entrada	100-240V CA 50/60Hz 10A máxima
Salida	100-240V CA 50/60Hz 10A máxima
ZigBee	IEEE 802.15.4
Sistemas operativos	Android & iOS
Temperatura de funcionamiento	-10~40°C
Materiales	PC
Dimensiones	42.6x42.6x20mm

Introducción al producto

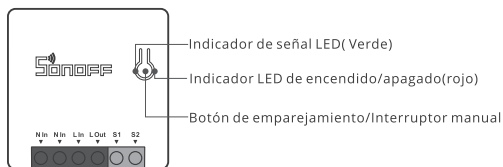

- ⚠ El peso del dispositivo es inferior a 1 kg.
Se recomienda una altura de instalación inferior a 2 m.

Características

El dispositivo inteligente SONOFF ZigBee que utiliza el protocolo de comunicación inalámbrica ZigBee le permite encender/apagar de forma remota, programar dispositivos conectados de encendido/apagado y configurar escenas inteligentes, entre otras funciones.



Control remoto desde plicación



Sincronización simple/regresiva



Control por voz



Escenas



Control compartido

- ⚠ Las funciones de más arriba están determinadas por ZigBee Hub.

Restablecimiento de los ajustes de fábrica

Mantenga presionado el botón de configuración durante 5 segundos hasta que el indicador de señal LED parpadee y suelte el botón. El restablecimiento se habrá realizado con éxito, El dispositivo se pone en modo de emparejamiento.

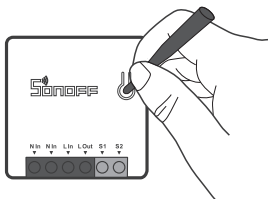

- ⓘ Si vuelve a emparejar el dispositivo con el concentrador, restablezca el dispositivo a sus ajustes predefinidos de fábrica.

L'appareil peut être utilisé de manière intelligente en travaillant avec la passerelle SONOFF ZigBee.

- ⓘ Le dispositif peut fonctionner avec d'autres passerelles prenant en charge le protocole sans fil ZigBee 3.0. Les informations détaillées sont conformes au produit final.

Éteindre

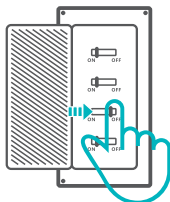

- ⚠ Pour éviter les électrocutions, prenez contact avec le revendeur ou un professionnel qualifié pour obtenir de l'aide pour l'installation et les réparations éventuelles! Veuillez ne pas toucher l'interrupteur pendant l'utilisation.

Instructions de câblage

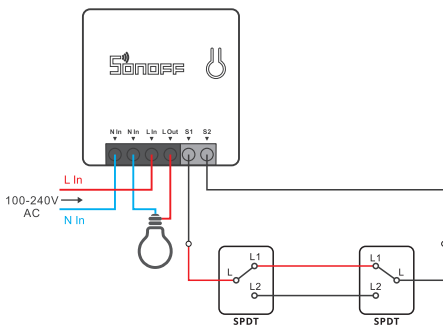

- ⓘ Assurez-vous que le fil neutre et le fil sous tension sont correctement installés.

- ⚠ S1/S2 peuvent se connecter au commutateur d'éclairage (le commutateur d'éclairage à rappel automatique n'est pas pris en charge) ou ne se connectent pas. Afin d'assurer la sécurité, ne pas lui connecter les fils de neutre et de phase.

Instructions de mise en place du ZSS

1. Téléchargez la dernière version de l'application Alexa



Amazon Alexa

2. Ajouter Amazon Echo

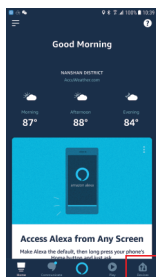

>

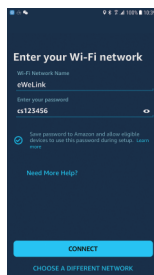

3. Ajouter l'appareil

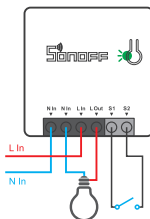

Après la mise sous tension de l'appareil, attendez 1 à 2 minutes pour actualiser la liste des appareils dans les App Alexa, et l'appareil ajouté apparaîtra dans la liste des appareils.

⚠ Veuillez essayer de coupler l'appareil en utilisant l'App eWeLink si la configuration du ZSS a échoué.

Couplage de l'App eWeLink

1. Télécharger l'application

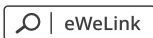

Android™ & iOS

2. Ajouter SONOFF ZigBee Bridge

3. Allumer

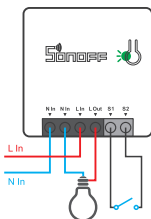

Après la mise sous tension, l'appareil passe en mode d'appairage lors de la première utilisation et l'indicateur de signal LED clignote.

⚠ L'appareil quittera le mode d'appairage si aucune opération suivante n'est effectuée pendant une longue période. Si vous entrez à nouveau, appuyez longuement sur l'interrupteur manuel pendant 5 secondes jusqu'à ce que l'indicateur de signal LED clignote et se relâche.

4. Ajouter des sous-appareils



>

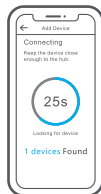

Accédez à eWeLink APP, sélectionnez la passerelle que vous souhaitez connecter et appuyez sur «Ajouter» pour ajouter un sous-dispositif, et soyez patient jusqu'à la fin de l'appairage.

⚠ Si l'ajout a échoué, rapprochez le sous-appareil de la passerelle et essayez à nouveau.

SONOFF ZigBee Passerelle permet de connecter plusieurs sous-appareils en même temps.

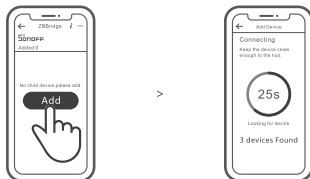

Allumez le Passerelle, mettez le sous-dispositif en mode d'appariement. Accédez ensuite à la page Passerelle dans eWeLink APP pour appuyer sur « Ajouter », et soyez patient jusqu'à ce que l'appariement soit terminé.

Plus de plateformes d'applications APP et de recommandations pour les passerelles



SmartThings



Amazon Alexa

Outre SONOFF ZigBee, ce dispositif prend en charge les passerelles suivantes:

Echo Studio
Echo Plus (model: ZE39KL)
2nd Gen Echo Show (model: DW84JL)
2nd Gen Echo Plus (model: L9D29R)
Samsung SmartThings hub

Passerelle ajoutant des instructions:

1. Consultez le manuel d'utilisation de la passerelle pour télécharger l'APP correspondant et le faire appairer.
2. Réglez ZBMINI sur le mode d'appariement.
3. Ajoutez ZBMINI selon l'invite de l'APP. Vous devez sélectionner eWeLink ou SONOFF lors de l'ajout.

⚠ Si l'ajout a échoué, rapprochez le sous-appareil de la passerelle et essayez à nouveau.

Caractéristiques techniques

Model	ZBMINI
Entrée max.	100-240V AC 50/60Hz 10A
Sortie max.	100-240V AC 50/60Hz 10A
ZigBee	IEEE 802.15.4
Systèmes d'exploitation	Android & iOS
Température de travail	-10~40°C
Matériaux	PC
Dimensions	42.6x42.6x20mm

Présentation du produit

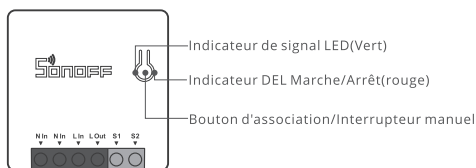

- ⚠ Le poids du dispositif est inférieur à 1 kg.
Il est recommandé d'installer le dispositif à une hauteur inférieure à 2 m.

Caractéristiques

L'Appareil intelligent SONOFF ZigBee sur le protocole de communication sans fil ZigBee vous permet d'allumer/éteindre à distance, de programmer l'allumage/l'extinction des appareils connectés, de définir des scènes intelligentes, etc.



Appli télécommande Chronométrage simple/compte à rebours Contrôle vocal Scènes intelligentes Contrôle partagé

- ⚠ Les fonctions ci-dessus sont déterminées par ZigBee Hub.

Rétablissement des paramètres d'usine

Appuyez longuement sur le bouton de configuration pendant 5 secondes jusqu'à ce que l'indicateur de signal LED clignote et se relâche, puis la réinitialisation est réussie. L'appareil entre en mode de couplage.

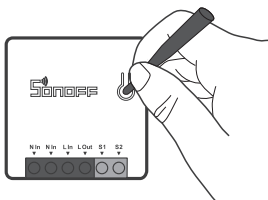

⚠ Si l'appareil est à nouveau jumelé à un concentrateur, réinitialisez l'appareil aux valeurs par défaut de l'usine.

Il dispositivo può essere azionato in modo intelligente attraverso SONOFF ZigBee Gateway.

⚠ Il dispositivo può essere utilizzato con altri gateway che supportano il protocollo wireless ZigBee 3.0. Le informazioni dettagliate sono conformi al prodotto finale.

Spegnimento

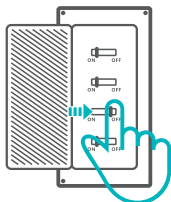

⚠ Per evitare scosse elettriche, consultare il rivenditore o un professionista qualificato per assistenza durante l'installazione e la riparazione!
Non toccare l'interruttore durante l'uso.

Istruzioni per il cablaggio

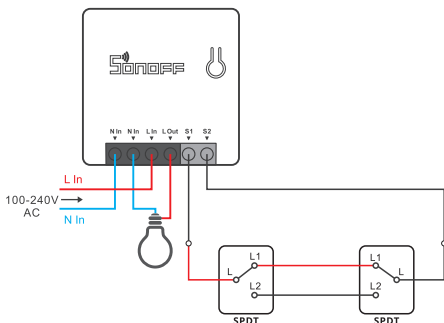

⚠ Assicurarsi che il collegamento del cavo di neutro e del cavo di fase sia corretto.

⚠ S1/S2 può essere collegato con l'interruttore della luce a bilanciere (gli interruttori della luce a bilanciere con ritorno automatico non sono supportati) o non si collega. Per garantire la sicurezza, non collegarvi il cavo neutro e il cavo sotto tensione.

Istruzioni di configurazione ZSS

1. Scarica l'ultima versione dell'App Alexa



Amazon Alexa

2. Aggiungi Amazon Echo

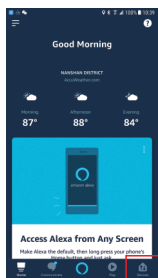

>

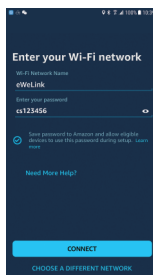

3. Aggiungere il dispositivo

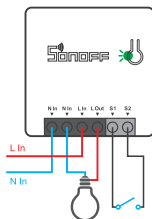

Dopo l'accensione del dispositivo, attendi 1-2 minuti e aggiorna l'elenco dei dispositivi nell'App Alexa; il dispositivo aggiunto dovrebbe apparire nell'elenco dei dispositivi.

⚠️ Cerca di associare il dispositivo usando l'applicazione eWeLink se la configurazione ZSS non è riuscita.

Associazione attraverso l'app eWeLink

1. Scarica la APP

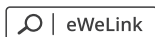

Android™ & iOS

2. Aggiungi SONOFF ZigBee Bridge

3. Accensione

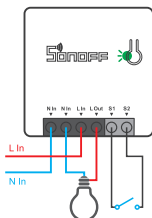

Al primo utilizzo, dopo l'accensione il dispositivo entrerà in modalità di associazione e l'indicatore LED lampeggerà.

⚠ Senza nessuna operazione successiva per un lungo periodo di tempo il dispositivo uscirà dalla modalità di associazione. Per entrare di nuovo, tenere premuto l'interruttore manuale per 5s fino a quando l'indicatore di segnale LED lampeggia e quindi rilasciare.

4. Aggiungere sotto-dispositivi

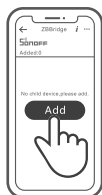

>

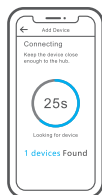

Accedere all'APP eWeLink, selezionare il Gateway che si vuole collegare e toccare "Add" per aggiungere un sotto-dispositivo, Attendere fino al completamento dell'operazione.

⚠ Se l'operazione di associazione non dovesse andare a buon fine, avvicinare il sotto-dispositivo al Gateway e riprovare.

SONOFF ZigBee Gateway permette di collegare più sotto-dispositivi contemporaneamente.

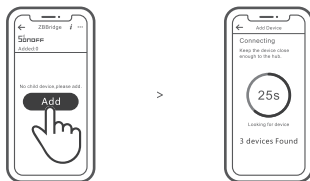

Accendere il Gateway, impostare il sotto-dispositivo sulla modalità di associazione. Quindi accedere alla pagina del Gateway nell'APP eWeLink selezionare "Add", e attendere fino al completamento del processo di associazione.

Ulteriori piattaforme, applicazioni e raccomandazioni per i gateway



SmartThings



Amazon Alexa

Questo dispositivo supporta i seguenti gateway oltre a SONOFF ZigBee:

Echo Studio
Echo Plus (Modello: ZE39KL)
2nd Gen Echo Show (Modello: DW84JL)
2nd Gen Echo Plus (Modello: L9D29R)
Samsung SmartThings hub

Istruzioni aggiuntive per il Gateway:

1. Fare riferimento al manuale utente del gateway per scaricare l'APP corrispondente e associarla.
2. Impostare ZBMINI in modalità abbinamento.
3. Aggiungere ZBMINI in base alle istruzioni dell'APP. Per aggiungere il dispositivo selezionare eWeLink o SONOFF.

⚠ Se l'operazione di associazione non dovesse andare a buon fine, avvicinare il sotto-dispositivo al Gateway e riprovare.

Specifiche

Modello	ZBMINI
Ingresso max	100-240V CA 50/60Hz 10A
Uscita max	100-240V CA 50/60Hz 10A
ZigBee	IEEE 802.15.4
Sistemi operativi	Android & iOS
Temperatura di funzionamento	-10~40°C
Materiali	PC
Dimensioni	42.6x42.6x20mm

Introduzione al prodotto

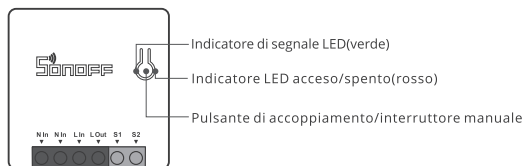

- ⓘ Il peso del dispositivo è inferiore a 1 kg.
Si raccomanda un'altezza di installazione inferiore a 2 m.

Caratteristiche

Il dispositivo intelligente SONOFF ZigBee basato sul protocollo di comunicazione wireless ZigBee consente di accendere/spengere, programmare acceso/spento i dispositivi connessi e impostare scenari intelligenti a distanza, ecc.



Telecomando
via APP



Conteggio singolo/
alla rovescia



Controllo vocale



Scene intelligenti



Controllo della
condivisione

- ⓘ Le funzioni illustrate sopra sono assegnate da ZigBee Hub.

Ripristino impostazioni di fabbrica

Tenere premuto il pulsante di configurazione per 5s fino a quando l'indicatore di segnale LED lampeggia e quindi rilasciarlo, il reset è stato eseguito. Il dispositivo entra in modalità di associazione.

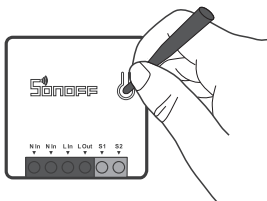

- ⚠ Se si associa nuovamente il dispositivo all'hub, rieseguire il reset di fabbrica del dispositivo.

Устройством можно управлять интеллектуально посредством шлюза SONOFF производства компании ZigBee.

⚠ Устройство может работать с другими шлюзами, поддерживающими беспроводной протокол ZigBee 3.0. Подробная информация соответствует характеристикам конечного изделия.

Выключить

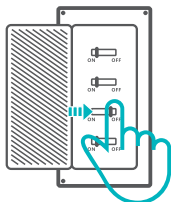

⚠ Во избежание поражения электрическим током при установке и ремонте обращайтесь за консультациями к продавцу или квалифицированному специалисту! Не касайтесь переключателя во время использования.

Инструкции по проводке

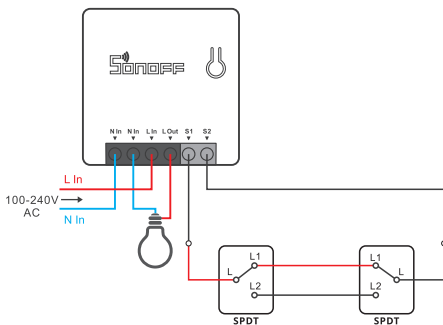

⚠ Убедитесь, что провод нейтрали (ноль) и провод под напряжением (фаза) подключены.

⚠ Возможно подключение S1/S2 с помощью переключателя-тумблера (возвратный переключатель-тумблер не поддерживается). В целях безопасности не подключайте к нему провод нейтрали и провод фазы.

Инструкция по первоначальной настройке ZSS

1. Загрузите последнюю версию App Alexa



Amazon Alexa

2. Добавьте Amazon Echo

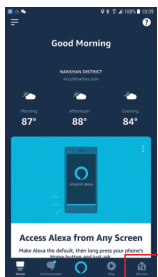

>

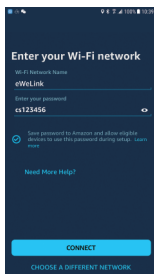

3. Добавить устройство

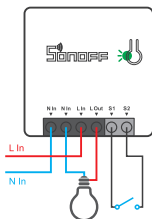

После включения питания подождите 1-2 минуты для обновления списка устройств в App Alexa при этом добавленное устройство отобразится в списке устройств.

⚠ Если начальная настройка ZSS не удалась, попробуйте установить соединение устройства при помощи App eWeLink.

Установка соединения при помощи App eWeLink.

1. Скачать приложение

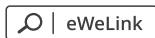

Android™ & iOS

2. Добавьте SONOFF ZigBee Bridge

3. Включить

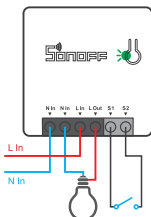

После включения, во время первого использования устройство перейдет в режим сопряжения, и замигают светодиодные сигнальные индикаторы.

⚠ Устройство выйдет из режима сопряжения, если на протяжении долгого времени не будет производиться никаких действий. Для повторного подключения зажмите на 5 секунд кнопку включения, после того, как загорятся светодиодные индикаторы, отпустите.

4. Добавьте суб-устройства



>

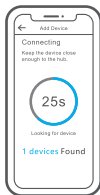

Осуществите доступ к приложению eWeLink, выберите шлюз, который желаете подключить, и коснитесь «Добавить», чтобы добавить суб-устройство, затем ждите завершения процесса установки соединения.

⚠ Если добавление не удалось, переместите суб-устройство ближе к шлюзу и повторите попытку.

Шлюз SONOFF ZigBee поддерживает одновременное подключение нескольких суб-устройств.

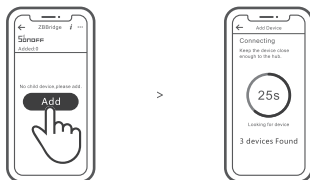

Включите питание шлюза, затем установите субустройство в режим сопряжения. Затем перейдите на страницу шлюза в приложении eWeLink, нажмите «Добавить», и подождите, пока сопряжение не будет завершено.

Больше платформ приложений и рекомендаций по шлюзу



SmartThings



Amazon Alexa

Данное устройство поддерживает следующие шлюзы кроме SONOFF ZigBee:

Echo Studio
Echo Plus (Модель: ZE39KL)
2nd Gen Echo Show (Модель: DW84JL)
2nd Gen Echo Plus (Модель: L9D29R)
Samsung SmartThings hub

Инструкция по добавлению шлюза:

1. Обратитесь к Руководству пользователя шлюза, чтобы скачать соответствующее приложение и выполнить сопряжение.
2. Установите ZBMINI в режим сопряжения.
3. Добавьте ZBMINI в соответствии с подсказкой приложения. Выберите eWeLink или SONOFF при добавлении.

⚠ Если добавление не удалось, переместите суб-устройство ближе к шлюзу и повторите попытку.

Технические характеристики

Модель	ZBMINI
Макс.входной ток	100-240В пер. тока 50/60Гц 10А
Макс.выходной ток	100-240В пер. тока 50/60Гц 10А
ZigBee	IEEE 802.15.4
Операционные системы	Android & iOS
Рабочая температура	-10~40°C
Материалы	PC
Размеры	42.6x42.6x20 мм

Знакомство с изделием

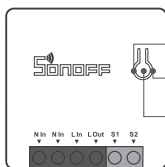

- Светодиодный сигнальный индикатор(зеленый)
- Светодиодный индикатор включения/выключения (красный)
- Кнопка сопряжения пе/реключения вручную

- ⓘ Вес устройства составляет менее 1 kg.
Рекомендуется устанавливать устройство на высоте менее 2 м.

Функции

Смарт-устройство SONOFF ZigBee, основанное на протоколе беспроводной связи ZigBee, позволит Вам удаленно включать/выключать, планировать включение/выключение подключенных устройств, настраивать смарт-сцены и т. д .



Управ. прилож.



Изолированный таймер/таймер обратного отсчета



Управл. голосом



Смарт-сюжеты



Доступ д/управл.

- ⓘ Вышеуказанные функции определяются ZigBee Hub.

Сброс до заводских настроек

На 5 секунд зажмите кнопку настройки до тех пор, пока не загорится светодиодный индикатор, затем отпустите. Сброс настроек прошел успешно. Устройство перешло в режим сопряжения.

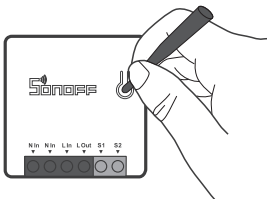

- ⚠ При повторном подключении устройства к шлюзу, сбросьте настройки устройства к заводским.

O dispositivo pode ser operado de maneira inteligente através do trabalho com o SONOFF ZigBee Bridge.

- ⚠ O dispositivo pode funcionar com outras entradas que suportam o protocolo sem fio ZigBee 3.0. Informações detalhadas estão de acordo com o produto final.

Desligar

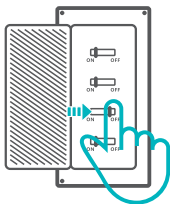

- ⚠ Para evitar choques elétricos, por favor consulte o seu distribuidor ou um profissional qualificado para auxiliar na instalação e reparo. Por favor não toque no painel durante o uso.

Instruções de instalação

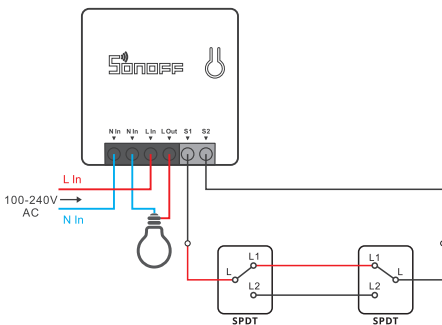

- ⚠ Certifique-se de que os cabos neutro e fase estejam conectados corretamente.
- ⚠ É possível conectar S1/S2 com o interruptor de luz (não admite os interruptores pulsadores) ou não o conectar. Para garantir a segurança, não conecte o cabo neutro e fase ao dispositivo.

Instruções de instalação do ZSS

1. Baixe o aplicativo Alexa mais recente



Amazon Alexa

2. Adicione Amazon Echo

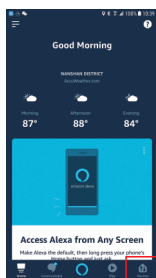

>

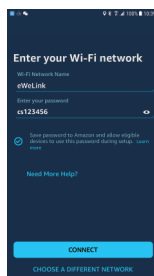

3. Adicione o aparelho

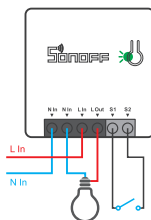

Depois que o dispositivo for ligado, aguarde de 1 a 2 minutos para atualizar a lista de dispositivos no Alexa App, e o dispositivo adicionado aparecerá na lista de dispositivos.

⚠ Tente emparelhar o dispositivo usando o eWeLink App se a configuração do ZSS falhar.

Emparelhamento do aplicativo eWeLink App

1. Baixe o aplicativo

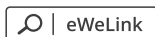

Android™ & iOS

2. Adicione SONOFF ZigBee Bridge

3. Ligue

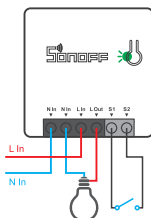

After powering on, the device will enter the pairing mode during the first use and the LED signal indicator flashes.

- ⓘ O dispositivo sairá em modo de pareamento se não houver alguma atividade durante um longo tempo. Se entrar novamente, por favor pressione o botão manual por 5 segundos até o indicador LED piscar e solte.

4. Adicionar sub-dispositivos

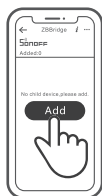

>

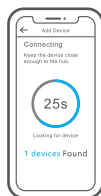

Acesse o aplicativo eWeLink, selecione o Bridge que você deseja conectar e toque em "Adicionar" para adicionar um sub-dispositivo, e seja paciente até que o emparelhamento seja concluído.

- ⓘ Se a adição falhar, mova o sub-dispositivo para mais perto do Bridge e tente novamente.

O SONOFF ZigBee Bridge suporta a conexão de vários sub-dispositivos ao mesmo tempo.

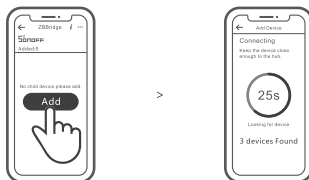

Ligue uma Bridge, defina o sub-dispositivo para o modo de comparação. Em seguida, acesse a página Bridge no eWeLink APP para tocar em "Adicionar" e seja paciente até que o comparador seja concluído.

Mais plataformas e gateways de aplicativos são recomendados.



SmartThings



Amazon Alexa

Este dispositivo suporta os seguintes entregas, além do SONOFF ZigBee Bridge:

Echo Studio
Echo Plus (Modelo : ZE39KL)
2nd Gen Echo Show (Modelo : DW84JL)
2nd Gen Echo Plus (Modelo : L9D29R)
Samsung SmartThings hub

Instruções para adição de entradas:

1. Consulte o manual do usuário para fazer o download do APP correspondente e emparelhamento com a internet.
2. Defina o dispositivo para o modo de emparelhamento.
3. Adicione o dispositivo de acordo com a instrução do APP. Você deve selecionar eWeLink ou SONOFF ao adicionar.

⚠ Se a adição falhar, mova o sub-dispositivo para mais perto do Bridge e tente novamente.

Parâmetros do produto

Modelo	ZBMINI
Entrada	100-240V AC 50/60Hz 10A
Saída	100-240V AC 50/60Hz 10A
ZigBee	IEEE 802.15.4
Sistemas operacionais	Android & iOS
Temperatura de trabalho	-10~40°C
Material de revestimento	PC
Dimensão	42.6x42.6x20 mm

Introdução ao produto

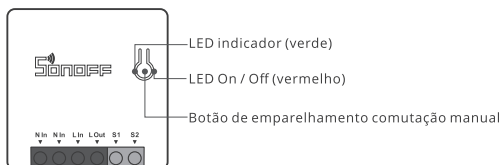

- ⓘ O peso do dispositivo é inferior a 1 kg.
Recomenda-se uma altura de instalação inferior a 2 m.

Funções

Os dispositivos SONOFF ZigBee inteligentes baseados no protocolo de comunicação sem fio ZigBee permitem ligar / desligar remotamente, agendar ligar / desligar dispositivos conectados e definir cenas inteligentes, etc.



Controle pelo aplicativo



Programador de tempo



Controle por voz



Cenas inteligentes



Compartilhar controle

- ⓘ As funções acima são determinadas pela porta de entrada do ZigBee.

Redefinição de fábrica

Mantenha o botão de sintonia pressionado por 5 segundos até o indicador LED acender e solte. A repositição foi bem sucedida. O dispositivo entrou no modo de emparelhamento.

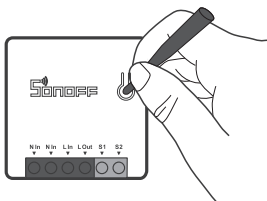

- ⚠ Ao reconectar o dispositivo ao gateway, redefina o dispositivo para as configurações de fábrica.

FCC Warning

Changes or modifications not expressly approved by the party responsible for compliance could avoid the user's authority to operate the equipment.

This device complies with part 15 of the FCC Rules. Operation is subject to the following two conditions: (1) This device may not cause harmful interference, and (2) this device must accept any interference received, including interference that may cause undesired operation.

FCC Radiation Exposure Statement:

This equipment complies with FCC radiation exposure limits set forth for an uncontrolled environment. This equipment should be installed and operated with minimum distance 20cm between the radiator & your body. This transmitter must not be co-located or operating in conjunction with any other antenna or transmitter.

Note:

This equipment has been tested and found to comply with the limits for a Class B digital device, pursuant to part 15 of the FCC Rules. These limits are designed to provide reasonable protection against harmful interference in a residential installation. This equipment generates, uses and can radiate radio frequency energy and, if not installed and used in accordance with the instructions, may cause harmful interference to radio communications. However, there is no guarantee that interference will not occur in a particular installation. If this equipment does cause harmful interference to radio or television reception, which can be determined by turning the equipment off and on, the user is encouraged to try to correct the interference by one or more of the following measures:

- Reorient or relocate the receiving antenna.
- Increase the separation between the equipment and receiver.
- Connect the equipment into an outlet on a circuit different from that to which the receiver is connected.
- Consult the dealer or an experienced radio/TV technician for help.

Hereby, Shenzhen Sonoff Technologies Co., Ltd. declares that the radio equipment type ZBMINI is in compliance with Directive 2014/53/EU. The full text of the EU declaration of conformity is available at the following internet address:

<https://www.sonoff.tech/usermanuals>

The logo features the word "SONOFF" in a bold, black, sans-serif font. Above the letter "O" in "SONOFF", there are three curved lines representing radio signal waves.

Shenzhen Sonoff Technologies Co., Ltd.

1001, BLDG8, Lianhua Industrial Park, shenzhen, GD, China

ZIP code: 518000

Website: sonoff.tech

MADE IN CHINA

